

# EVAPORATOR HOUSING

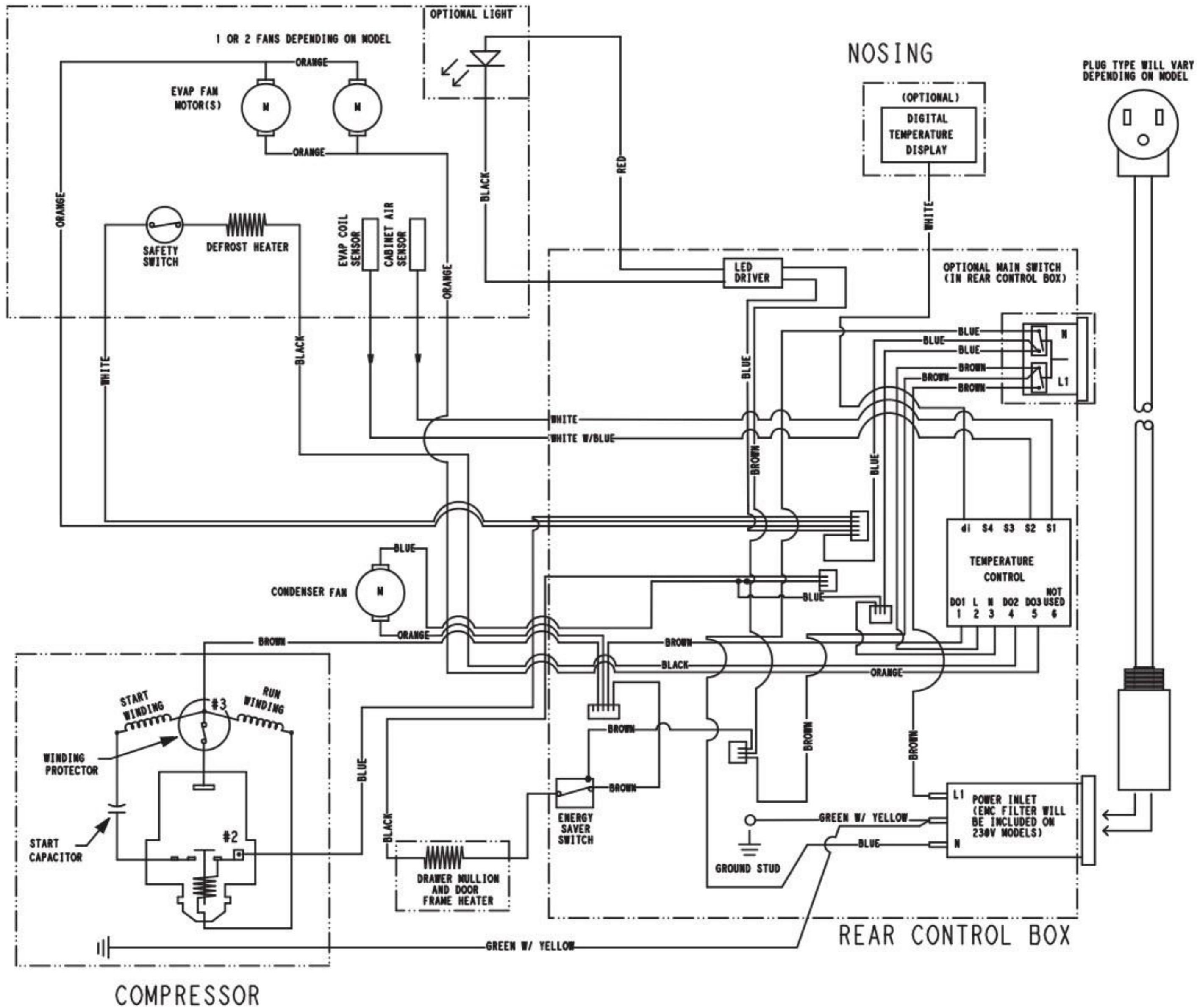

LINE VOLTAGE  
115/60/1 STANDARD  
230/50/1 OPTIONAL

L1

M



OPTIONAL MAIN SWITCH

OPTIONAL LIGHT

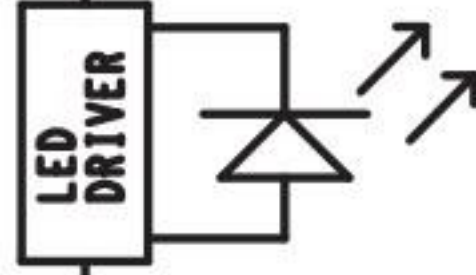

TEMPERATURE CONTROL

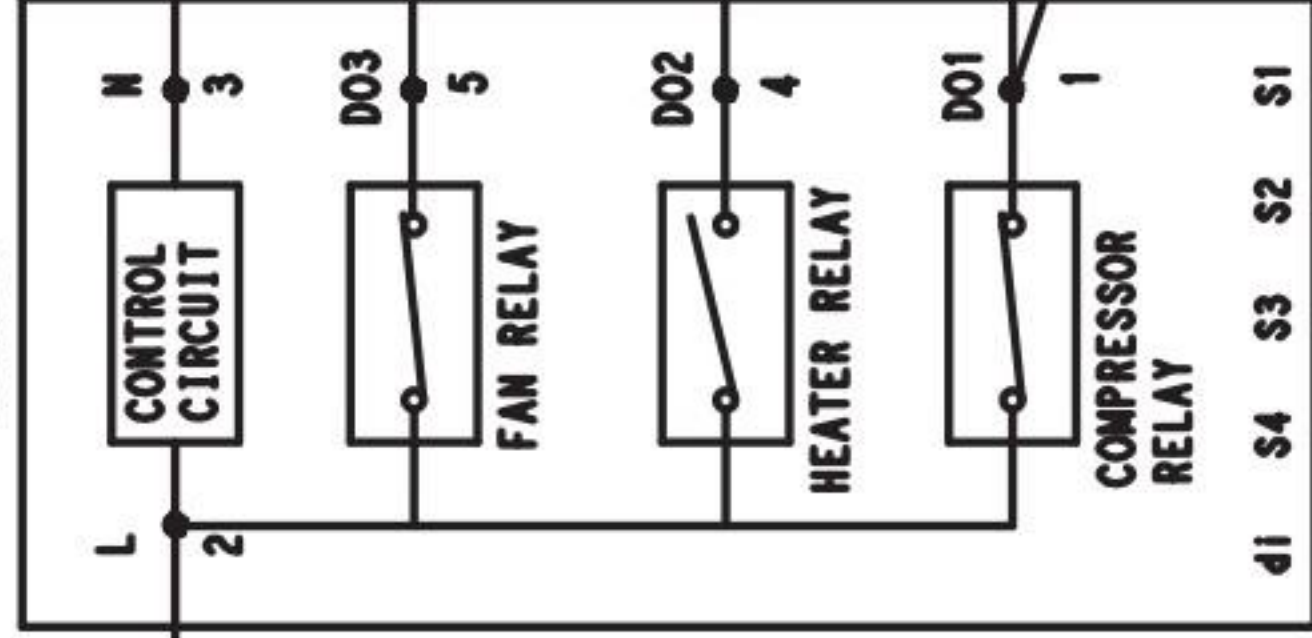

L

M

2

3

5

D03

4

D02

1

D01

d1

S4

S3

S2

S1



M



FAN RELAY



HEATER RELAY



COMPRESSOR RELAY



EVAPORATOR FAN(S)  
UP TO (2) FANS POSSIBLE  
DEPENDING ON MODEL



SAFETY SWITCH



DEFROST HEATER  
(FREEZER ONLY)



COMPRESSOR



CONDENSOR FAN



EVAP COIL SENSOR



CABINET AIR SENSOR

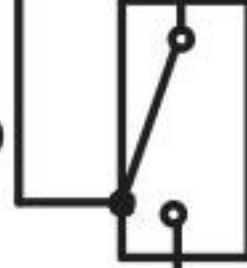

ENERGY SAVER SWITCH



DRAWER MULLION  
AND DOOR  
FRAME HEATERS



LINE VOLTAGE  
115/60/1 STANDARD  
230/50/1 OPTIONAL

L1

N

OPTIONAL LIGHT

LED DRIVER

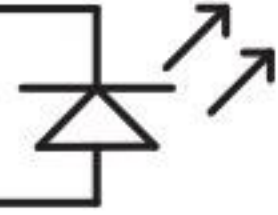

TEMPERATURE CONTROL

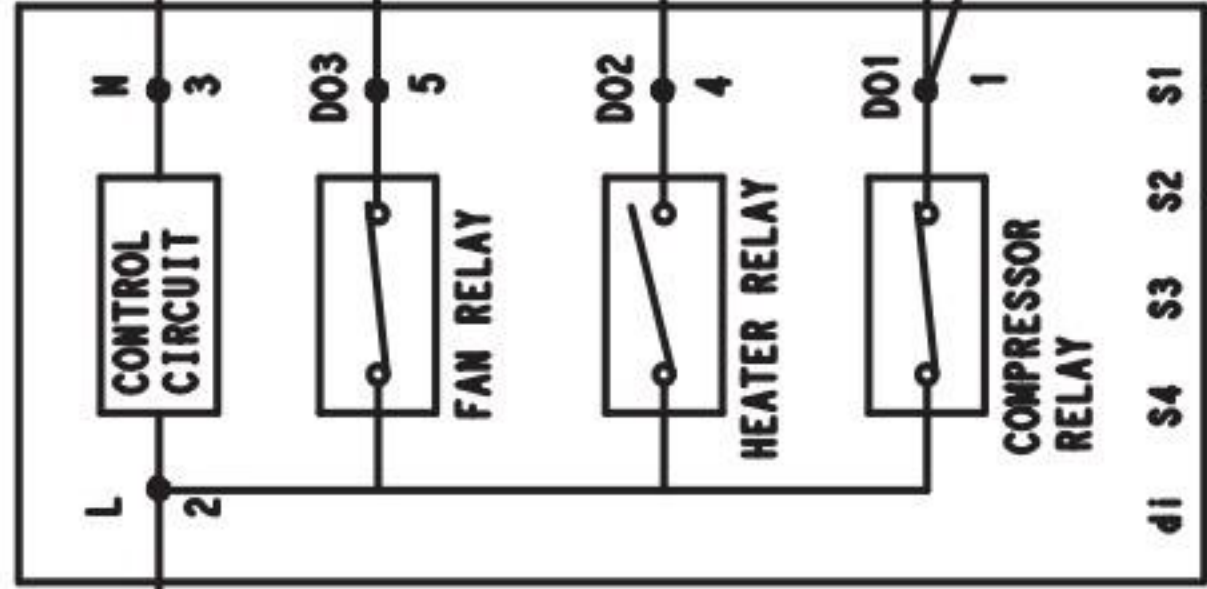

EVAPORATOR FAN(S)  
UP TO (2) FANS POSSIBLE  
DEPENDING ON MODEL



DEFROST HEATER  
(FREEZER ONLY)



COMPRESSOR



CONDENSOR FAN

EVAP COIL SENSOR

CABINET AIR SENSOR

ENERGY SAVER SWITCH

DRAWER MULLION AND DOOR FRAME HEATERS



LINE VOLTAGE  
115/60/1 STANDARD  
230/50/1 OPTIONAL

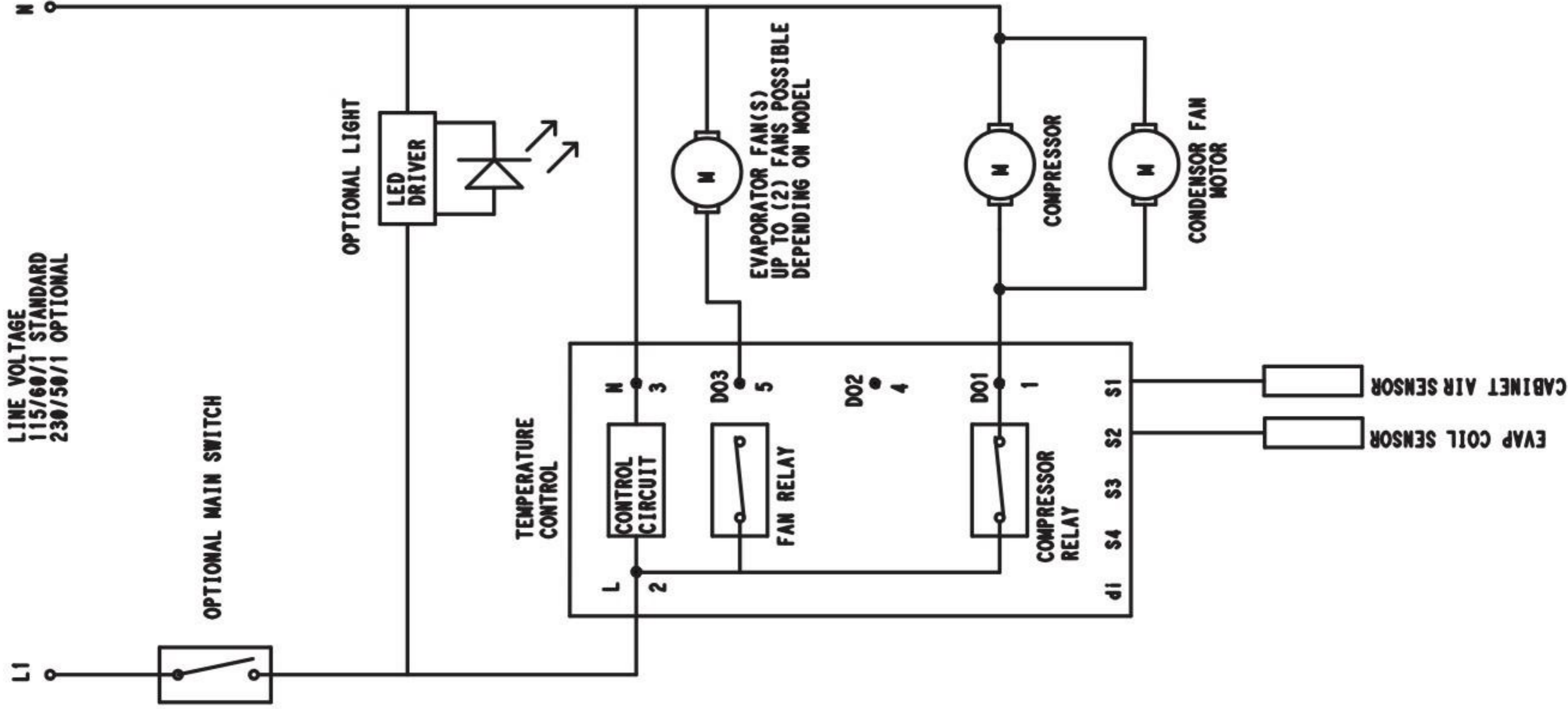

OPTIONAL MAIN SWITCH

OPTIONAL LIGHT

LED DRIVER

TEMPERATURE CONTROL

CONTROL CIRCUIT

FAN RELAY

COMPRESSOR RELAY

EVAPORATOR FAN(S)  
UP TO (2) FANS POSSIBLE  
DEPENDING ON MODEL

COMPRESSOR

CONDENSOR FAN MOTOR

EVA P COIL SENSOR

CABINET AIR SENSOR

# EVAPORATOR HOUSING

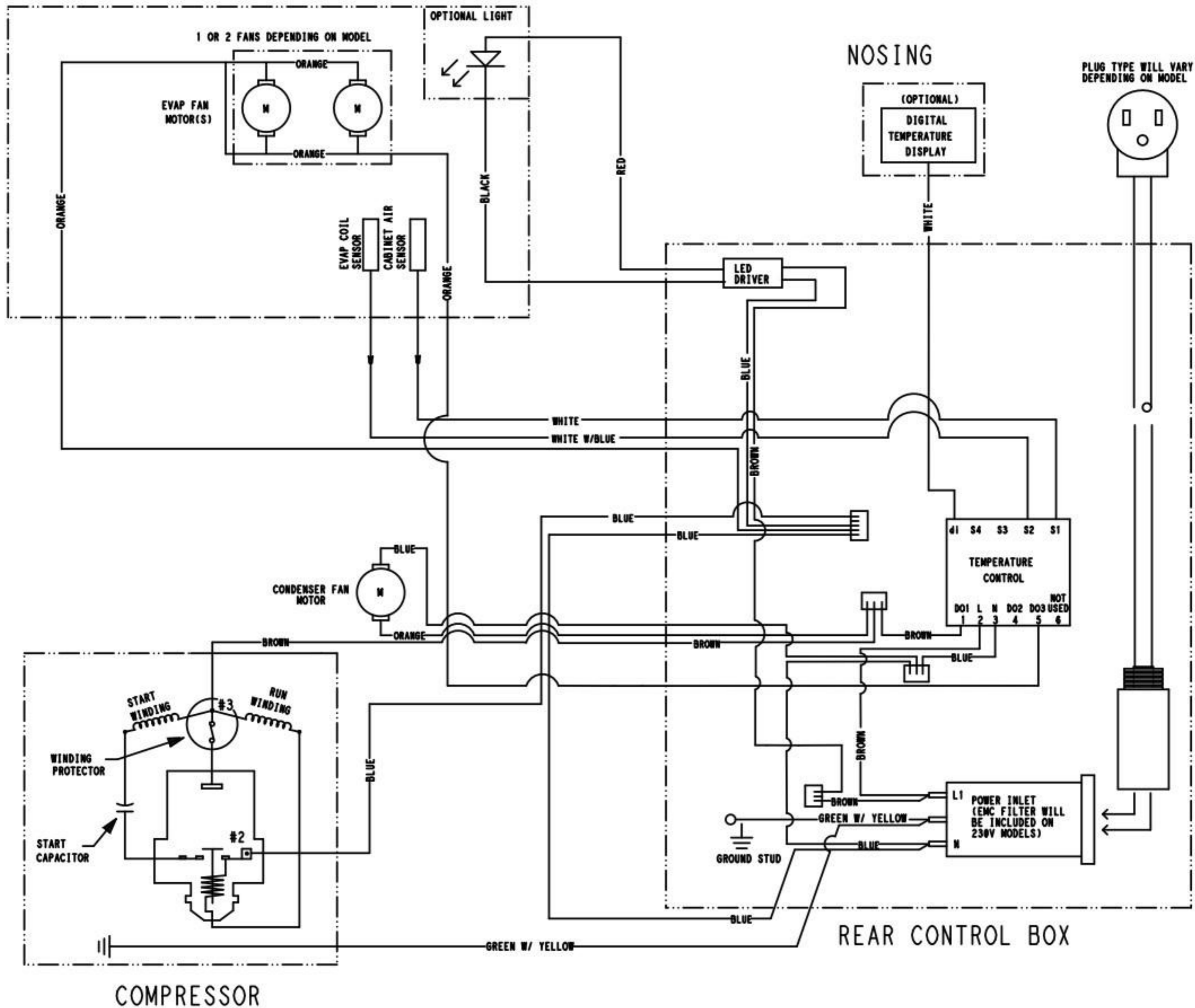

LINE VOLTAGE  
115/60/1 STANDARD  
230/50/1 OPTIONAL

