

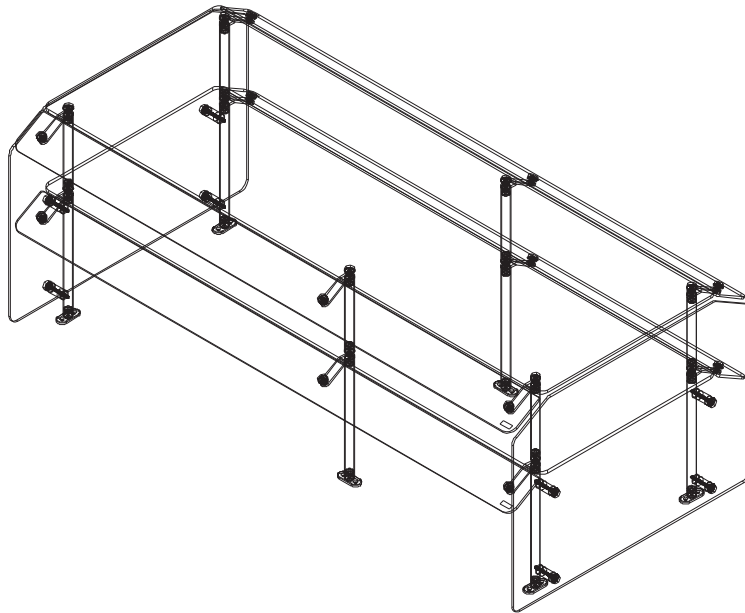

FlexiShield® Food Shields

Installation & Care Manual

Please read this manual completely before attempting to install or operate this equipment!
Notify carrier of damage! Inspect all components immediately.



**Important Information
Read Before Use
Please Save These Instructions!**

June 2013

Important Warning And Safety Information



WARNING

Read This Manual Thoroughly Before Operating, Installing, Or Performing Maintenance On The Equipment.



WARNING

Failure To Follow Instructions In This Manual Can Cause Property Damage, Injury Or Death.



WARNING

Do Not Store Or Use Gasoline Or Other Flammable Vapors Or Liquids In The Vicinity Of This Or Any Other Appliance.



WARNING

This Appliance Is Not Intended For Use By Persons Who Lack Experience Or Knowledge, Unless They Have Been Given Supervision Or Instruction Concerning Use Of The Appliance By A Person Responsible For Their Safety.



WARNING

This Appliance Is Not To Be Played With.



WARNING

Do Not Clean With Water Jet.



CAUTION

Observe the following:

- Minimum clearances must be maintained from all walls and combustible materials.
- Keep the equipment area free and clear of combustible material.
- Allow adequate clearance for air openings.
- Operate equipment only on the type of electricity indicated on the specification plate.
- Unplug the unit before making any repairs.
- Retain this manual for future reference.

Contents

Receiving & Inspecting The Equipment	3
Warranty Information.....	4
Regulatory Certifications.....	4
Specifications	5-6
Installation.....	7
Maintenance.....	8
Replacement Parts.....	9-10
Standard Labor Guidelines	11

Receiving And Inspecting The Equipment

Care should be taken during unloading so the equipment is not damaged while being moved into the building.

1. Visually inspect the exterior of the package and skid or container. Any damage should be noted and reported to the delivering carrier immediately.
2. If damaged, open and inspect the contents with the carrier.
3. In the event that the exterior is not damaged, yet upon opening, there is concealed damage to the equipment notify the carrier. Notification should be made verbally as well as in written form.
4. Request an inspection by the shipping company of the damaged equipment. This should be done within 10 days from receipt of the equipment.
5. Freight carriers can supply the necessary damage forms upon request.
6. Retain all crating material until an inspection has been made or waived.

Warranty Information

Visit http://www.delfield.com/minisite/service/warranty_info to:

- Register your product for warranty.
- Verify warranty information.
- View and download a copy of your warranty.

Regulatory Certifications

All Models are certified by:

 **National Sanitation Foundation (NSF)**

Electrical models are also certified by:

 **Underwriters Laboratories (UL)**
Underwriters Laboratories of Canada (ULC)

©2013 The Delfield Company. All rights reserved. Reproduction without written permission is prohibited.

"Delfield" is a registered trademarks of The Delfield Company.

Specifications

Radial Glass Front, Single Tier with Glass Shelf, Single Service, Inside & Outside

<i>Model</i>	<i>L</i>	<i>W</i>	<i>H</i>
DCFSRIG-2	38.47"	18.00"	18.00"
DCFSRIG-3	53.43"	18.00"	18.00"
DCFSRIG-4	68.17"	18.00"	18.00"
DCFSRIG-5	82.61"	18.00"	18.00"
DCFSROG-2	43.09"	18.00"	18.00"
DCFSROG-3	59.85"	18.00"	18.00"
DCFSROG-4	76.35"	18.00"	18.00"
DCFSROG-5	92.53"	18.00"	18.00"

Radial Single Tier, Fixed Sneeze Guard Front, Dual Service

<i>Model</i>	<i>L</i>	<i>W</i>	<i>H</i>
DCFSRKD-2	40.78"	35.50"	14.75"
DCFSRKD-3	56.64"	35.50"	14.75"
DCFSRKD-4	72.26"	35.50"	14.75"
DCFSRKD-5	87.57"	35.50"	14.75"

Radial Single Tier, Fixed Sneeze Guard Front, Single Service, Inside & Outside

<i>Model</i>	<i>L</i>	<i>W</i>	<i>H</i>
DCFSRIKS-2	38.47"	18.00"	14.75"
DCFSRIKS-3	53.43"	18.00"	14.75"
DCFSRIKS-4	68.17"	18.00"	14.75"
DCFSRIKS-5	82.61"	18.00"	14.75"
DCFSROKS-2	43.09"	18.00"	14.75"
DCFSROKS-3	59.85"	18.00"	14.75"
DCFSROKS-4	76.35"	18.00"	14.75"
DCFSROKS-5	92.53"	18.00"	14.75"

Overshelf, Radial Front

<i>Model</i>	<i>L</i>	<i>W</i>	<i>H</i>
DCFSCR	24.00" (61cm)	24.00" (61cm)	16.00" (41cm)
DCFSCRD	24.00" (61cm)	24.00" (61cm)	26.00" (66cm)
DCFSOS-XX	XX"	18.00" (46cm)	16.00" (41cm)
DCFSOS2-XX	XX"	18.00" (46cm)	26.00" (66cm)

Specifications, continued

Glass Front, Single Tier with Glass Shelf, Single Service

<i>Model</i>	<i>L</i>	<i>W</i>	<i>H</i>
DCFSG	XX	18.00" (46cm)	16.00" (41cm)

Glass Front, Double Tier with Two Glass Shelves, Single Service

<i>Model</i>	<i>L</i>	<i>W</i>	<i>H</i>
DCFSG2	XX	18.00" (46cm)	26.00" (66cm)

Glass Front, Slicer Shield Style

<i>Model</i>	<i>L</i>	<i>W</i>	<i>H</i>
DCFSSS	XX	18.00" (46cm)	YY

Two Tier Display, Sneeze Guard, Single Service

<i>Model</i>	<i>L</i>	<i>W</i>	<i>H</i>
DCFSH	XX	18.00" (46cm)	26.00" (66cm)

Two Tier Display With Sneeze Guard, Dual Service

<i>Model</i>	<i>L</i>	<i>W</i>	<i>H</i>
DCFSHD	XX	33.50" (85cm)	26.00" (66cm)

Flexible Shield, Converts to Three Positions

<i>Model</i>	<i>L</i>	<i>W</i>	<i>H</i>
DCFSS	XX	18.00" (46cm)	16.00" (41cm)

Flexible Shield, Converts to Three Positions, Two Tier

<i>Model</i>	<i>L</i>	<i>W</i>	<i>H</i>
DCFSS2	XX	18.00" (46cm)	26.00" (66cm)

Single Tier, Fixed Sneeze Guard Front, Dual Service

<i>Model</i>	<i>L</i>	<i>W</i>	<i>H</i>
DCFSDK	XX	33.50" (85cm)	16.00" (41cm)

Single Tier, Fixed Sneeze Guard Front, Single Service

<i>Model</i>	<i>L</i>	<i>W</i>	<i>H</i>
DCFSSK	XX	18.00" (46cm)	16.00" (41cm)

Double Tier, Bottom Tier Full Glass Front, Second Tier Sneeze Guard

<i>Model</i>	<i>L</i>	<i>W</i>	<i>H</i>
DCFSGH	XX	18.00" (46cm)	26.00" (66cm)

Double Tier, Bottom Tier Sneeze Guard, Second Tier Full Glass Front

<i>Model</i>	<i>L</i>	<i>W</i>	<i>H</i>
DCFSHG	XX	18.00" (46cm)	26.00" (66cm)

FlexiShield® Food Shields Installation

1. Set food shield on base unit. See Figure 1.
2. Mark hole locations.
 - For counter top mounting mark the flange holes. See Figure 2.
 - For under counter mounting mark the leg locations.
3. Drill holes in base unit.
 - For counter top mounting drill 5/32" holes.
 - For under counter mounting drill 3/8" holes.
4. Install with screws provided.
 - For counter top mounting install with screws through the flanges.
 - For under counter mounting install with 1/4"-20 bolts and washers from beneath the counter. See Figure 3.
5. Make any necessary electrical connections.
6. If applicable test lights, heat lamps etc.
7. Adjust glass for proper alignment and ensure that all hardware is tightened securely.
8. Clean food shield and glass with mild soap and water.

FlexiShield® food shields are to be used as food and counter protection only and should not be used in any other way.

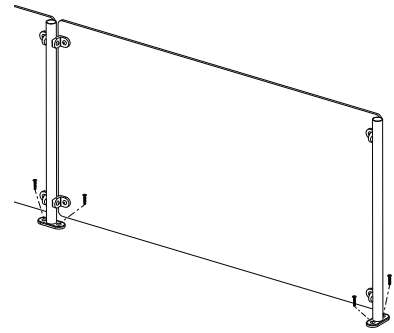

Figure 1. By placing the food shield on the base unit, hole locations can be marked.

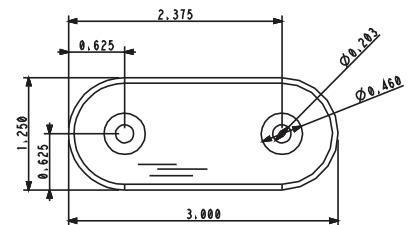

Figure 2. Flange dimensions

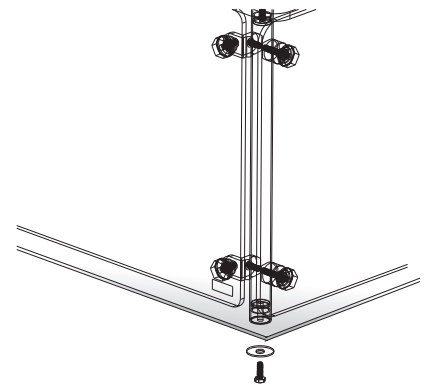

Figure 3. Bolt and washer beneath counter.

Maintenance

Hardware And Glass Cleaning

Routine cleaning can be done with soap and water. Extreme stains or grease should be cleaned with a non-abrasive cleaner and plastic scrub pad.

Polish the chrome when necessary with a soft cotton cloth.

Stainless Steel Care and Cleaning

To prevent discoloration or rust on stainless steel several important steps need to be taken. First, we need to understand the properties of stainless steel. Stainless steel contains 70- 80% iron, which will rust. It also contains 12-30% chromium, which forms an invisible passive film over the steel's surface, which acts as a shield against corrosion. As long as the protective layer is intact, the metal is still stainless. If the film is broken or contaminated, outside elements can begin to breakdown the steel and begin to form discoloration or rust. Proper cleaning of stainless steel requires soft cloths or plastic scouring pads.





NEVER USE STEEL PADS, WIRE BRUSHES OR SCRAPERS!

Cleaning solutions need to be alkaline based or non-chloride cleaners. Any cleaner containing chlorides will damage the protective film of the stainless steel. Chlorides are also commonly found in hard water, salts, and household and industrial cleaners. If cleaners containing chlorides are used be sure to rinse repeatedly and dry thoroughly. Routine cleaning of stainless steel can be done with soap and water. Extreme stains or grease should be cleaned with a non-abrasive cleaner and plastic scrub pad. Always rub with the grain of the steel. There are stainless steel cleaners available which can restore and preserve the finish of the steels protective layer. Early signs of stainless steel breakdown are small pits and cracks. If this has begun, clean thoroughly and start to apply stainless steel cleaners in attempt to restore the passivity of the steel.

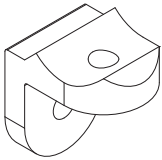
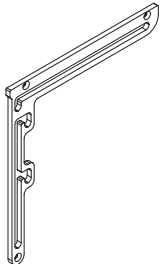
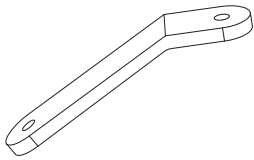
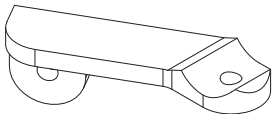
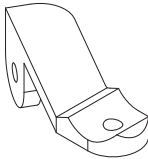

Never use an acid based cleaning solution! Many food products have an acidic content, which can deteriorate the finish. Be sure to clean the stainless steel surfaces of ALL food products. Common items include, tomatoes, peppers and other vegetables.

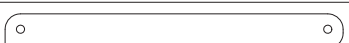
Replacement Parts

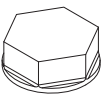
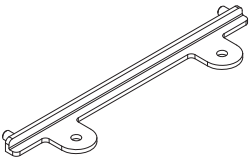
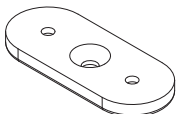
<i>Part Description</i>	<i>Part Drawing (Not to scale)</i>	<i>Chrome Part #</i>	<i>Black Part #</i>
Bracket, glass, front		3235509	3235538
Bracket, glass, front, convertible		3235534	3235549
Bracket, sneeze, 30° angle		3235507	3235540
Bracket, sneeze, radial, front		3235536	3235552
Bracket, sneeze, radial, left		3235537	3235553
Bracket, top, convertible, center		3235511	3235545
Bracket, top, convertible, left		3235512	3235546
Bracket, top, convertible, right		3235510	3235544
Bushing, black		9321158	9321158
Cap, Threaded, 1.00"		3235500	3235539
Clip, glass, front, convertible		3235533	3235548
Flanged foot		3235506	3235550

Replacement Parts, continued

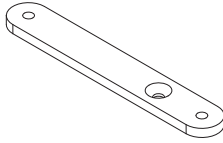
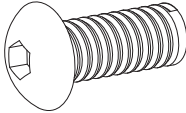
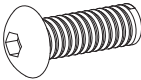
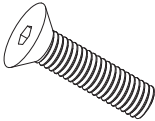
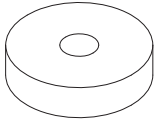
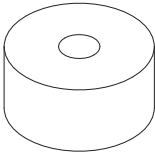
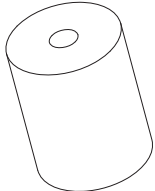
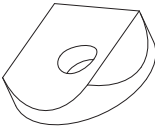
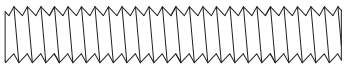
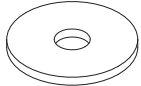
Part Description	Part Drawing (Not to scale)	Chrome Part #	Black Part #
Plate, leg, mounting, radial		3235535	3235551
Screw, 1/4-20x5/8", attaching hardware to glass		9321393	9321393
Screw, 1/4-20x3/4", attaching hardware to glass		9321395	9321395
Screw, 1/4-20x1", to attach flanged foot to the tubing leg		9321394	9321394
Screw, #10x1.25", Phillips Oval Head, to attach flanged foot to counter		9321523	9321523
Spacer, 1/4"		3235503	3235541
Spacer, 1/2"		3235501	3235543
Spacer, 1 1/4"		3235502	3235543
Spacer, tubing, 1/4"		3235508	3235547
Stud, threaded, 1/4"x1.50"long		9321132	9321132
Washer, Black, 1"x.075"		3235504	3235504

Standard Labor Guidelines To Repair Or Replace Parts On Delfield Equipment

Advice and recommendations given by Delfield Service Technicians do not constitute or guarantee any special coverage.

- A maximum of 1-hour is allowed to diagnose a defective component.
- A maximum of 1-hour is allowed for retrieval of parts not in stock.
- A maximum travel distance of 100 miles round trip and 2-hours will be reimbursed.
- Overtime, installation/start-up, normal control adjustments, general maintenance, glass breakage, freight damage, and/or correcting an end-user installation error will not be reimbursed under warranty unless pre-approved with a Service Work Authorization from Delfield. You must submit the number with the service claim.



Mt. Pleasant, MI



Covington, TN

Thank you for choosing Delfield!

Help is a phone call away. Help our team of professional, courteous customer service reps by having your model number and serial number available at the time of your call (800) 733-8829.

Model: _____ S/N: _____

Installation Date: _____



For a list of Delfield's authorized parts depots, visit our website at www.delfield.com

Register your Delfield warranty online. Go to www.delfield.com under the service tab to complete.

