

LINE VOLTAGE
220V/50Hz/1Ph
SEE NAMEPLATE FOR MAXIMUM
FUSE SIZE

TERMINAL
BLOCK

L

N

G

BROWN

BLUE

GRN-YEL

MULLION
HEATER

DEFROST
TIMER

HI-LIMIT

DEFROST
HEATER

EVAPORATOR FAN

TEMPERATURE
CONTROL

COMPRESSOR

CONDENSOR FANS

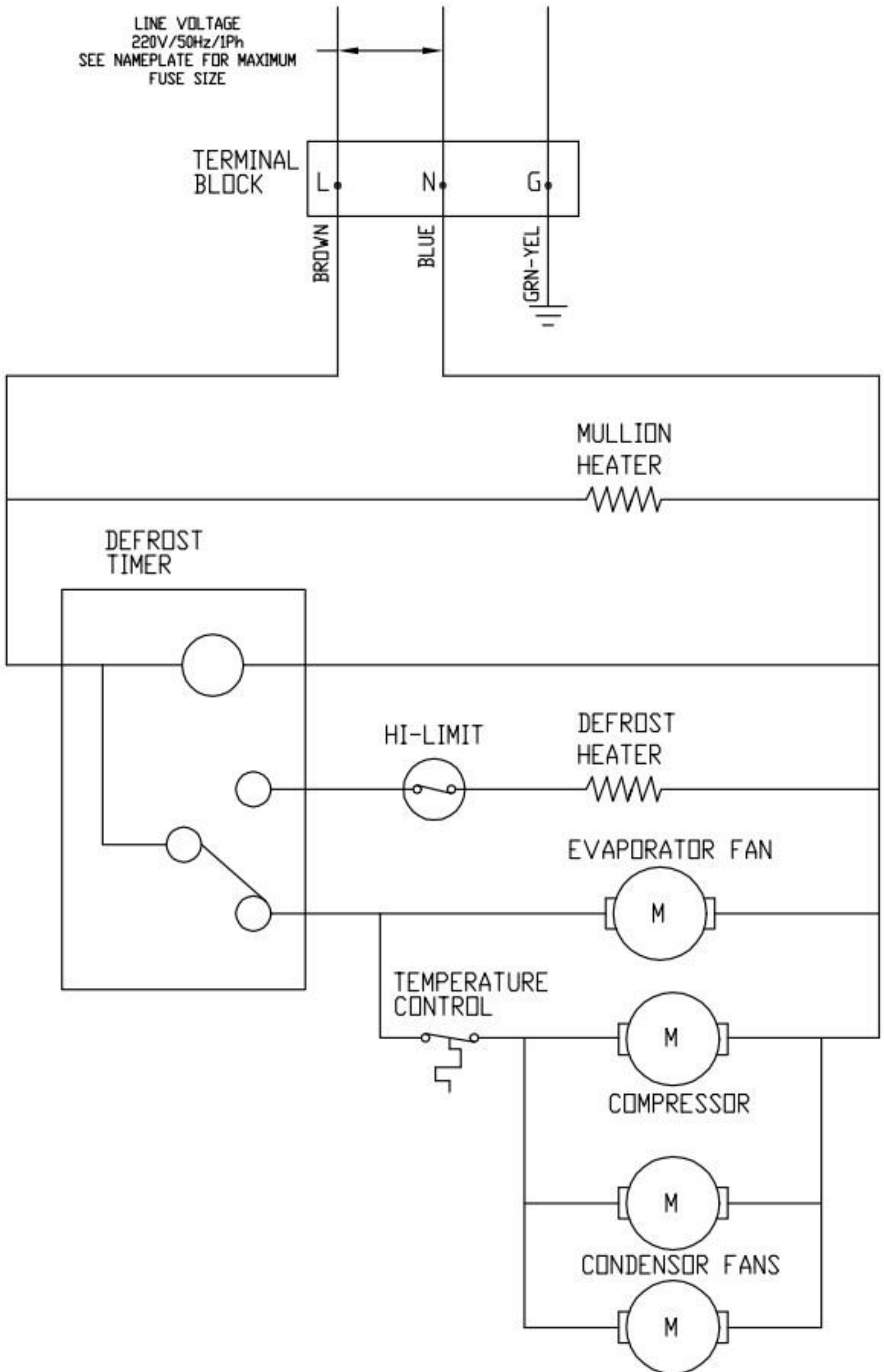

LINE VOLTAGE
220V/50Hz/1Ph
SEE NAMEPLATE FOR MAXIMUM
FUSE SIZE

TERMINAL
BLOCK

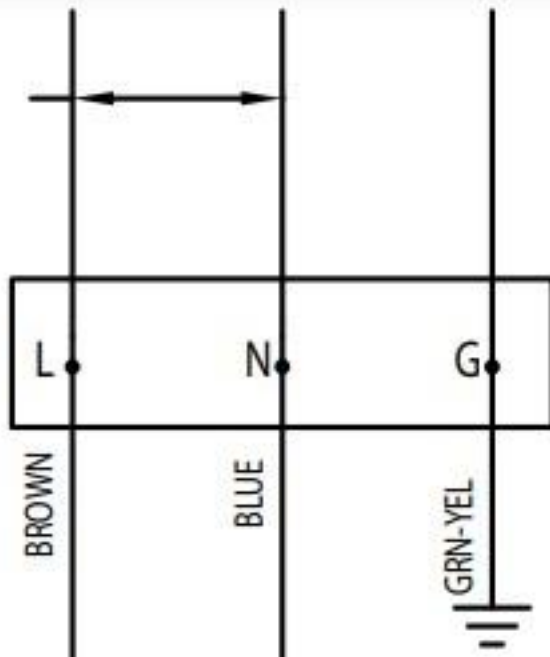

TEMPERATURE
CONTROL

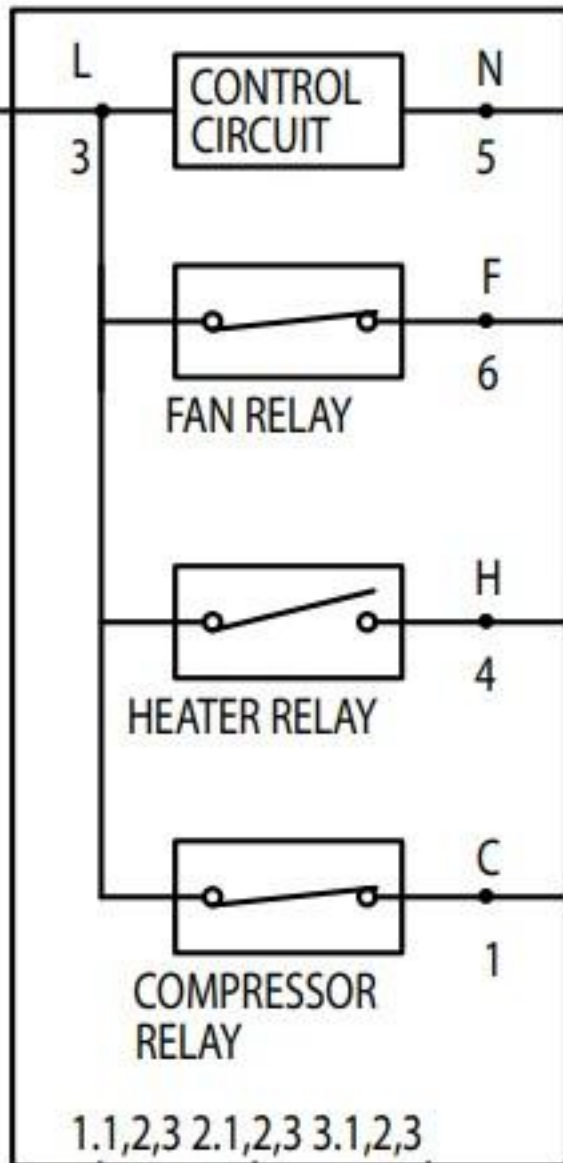

LED DISPLAY
(IF USED)

EVAP COIL
SENSOR

CABINET AIR
SENSOR

EVAPORATOR FAN

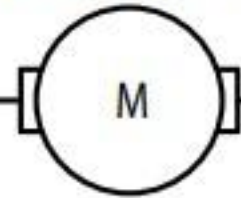

HI-LIMIT

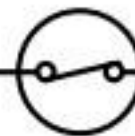

DEFROST
HEATER

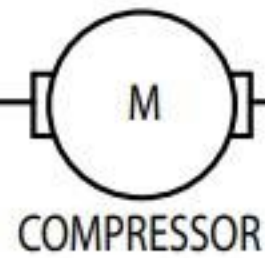

COMPRESSOR

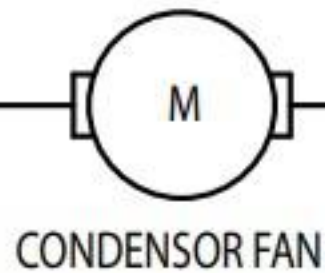

CONDENSOR FAN

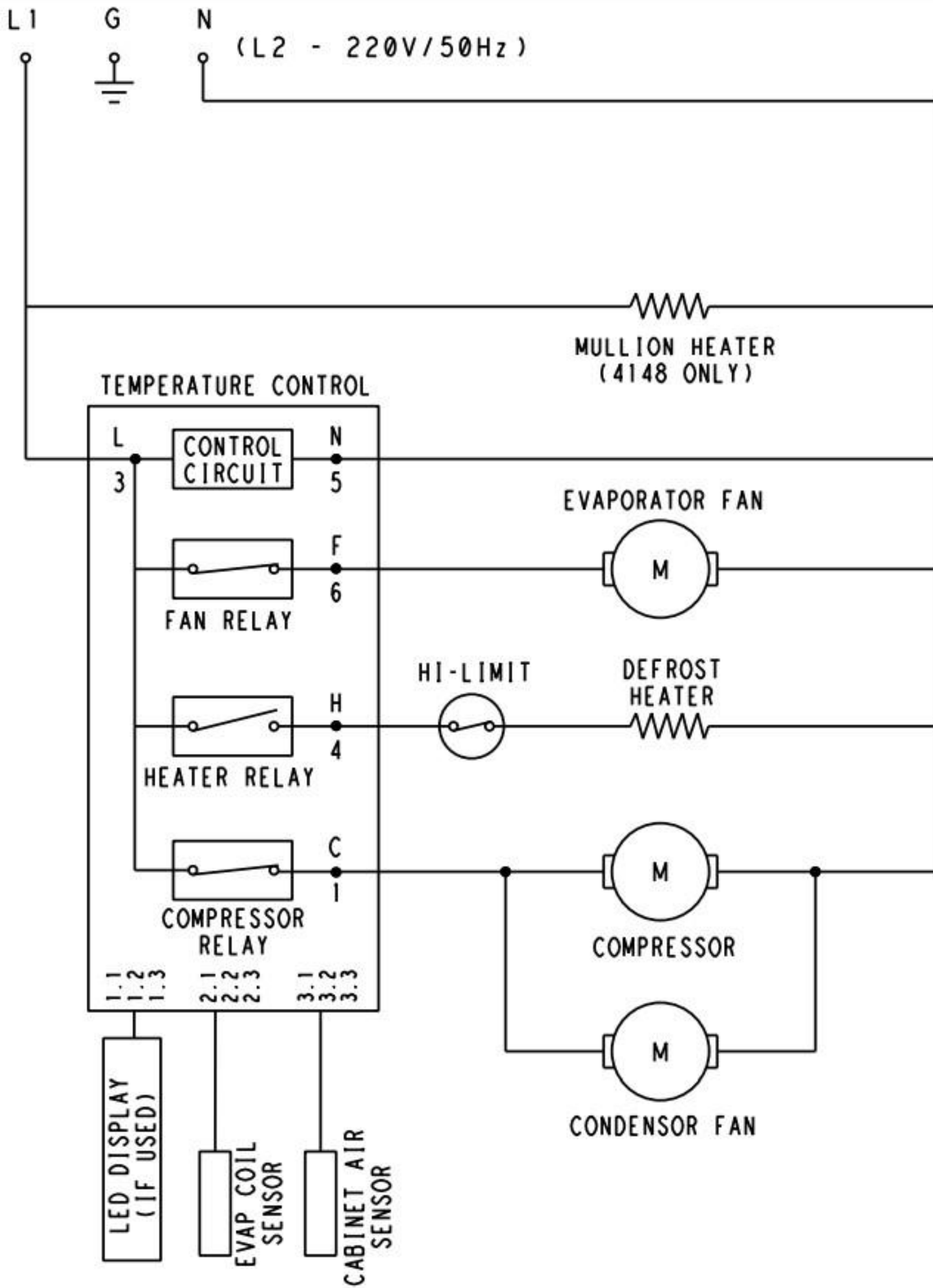

L1

G

N

(L2 - 220V/50Hz)

TEMPERATURE CONTROL

L

3

CONTROL
CIRCUIT

N

5

FAN RELAY

F

6

HEATER RELAY

H

4

COMPRESSOR
RELAY

C

1

1.1
1.2
1.3

2.1
2.2
2.3

3.1
3.2
3.3

LED DISPLAY
(IF USED)

EVAP COIL
SENSOR

CABINET AIR
SENSOR

MULLION HEATER
(4148 ONLY)

EVAPORATOR FAN

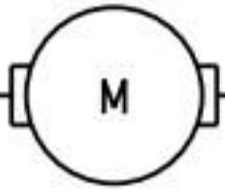

HI-LIMIT

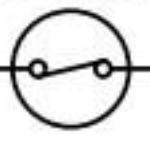

DEFROST
HEATER

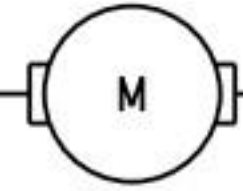
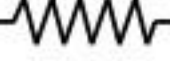

COMPRESSOR

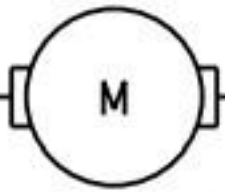

CONDENSOR FAN

LINE VOLTAGE
220V/50Hz/1Ph
SEE NAMEPLATE FOR MAXIMUM
FUSE SIZE

TERMINAL
BLOCK

L

N

G

BROWN

BLUE

GRN-YEL

EVAPORATOR FAN

M

TEMPERATURE
CONTROL

M

ORANGE

COMPRESSOR

M

CONDENSOR FAN

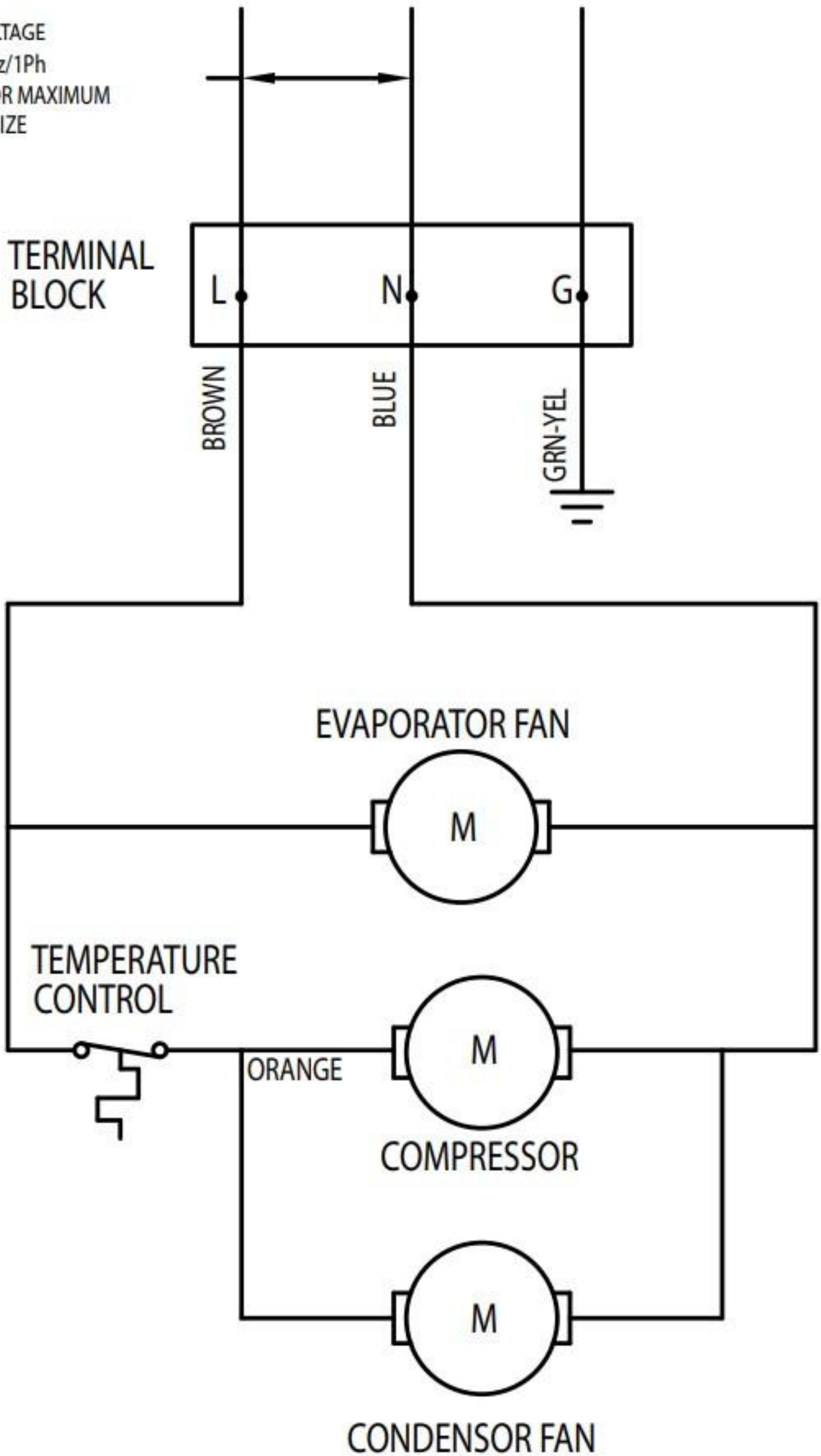

L1 G N
(L2 - 220V/50Hz)

TEMPERATURE CONTROL

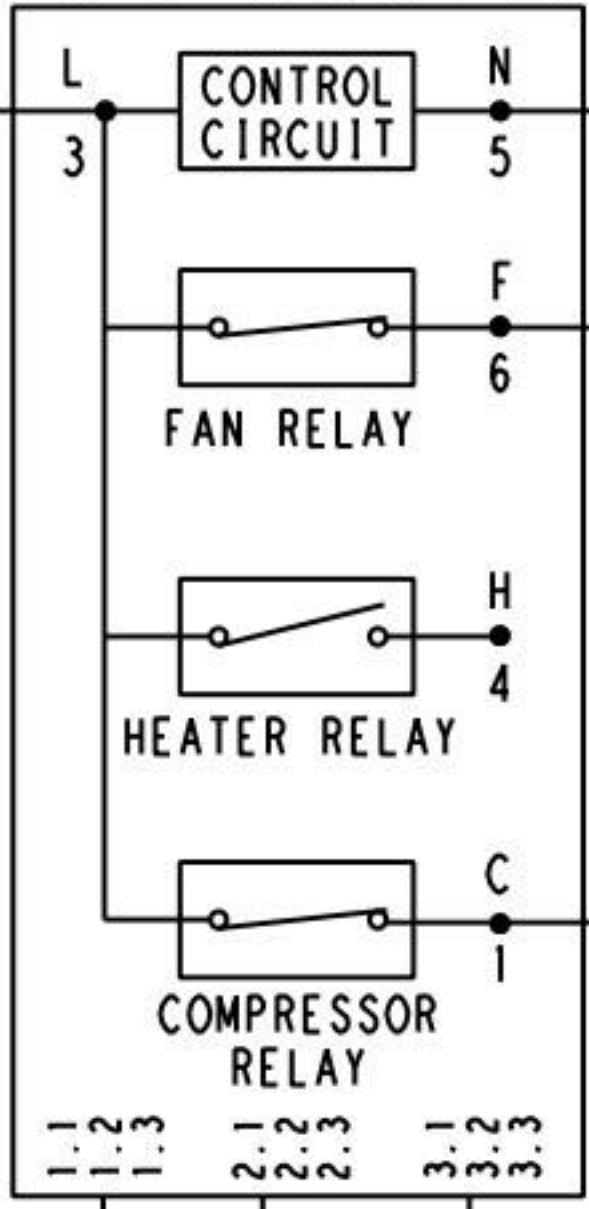

EVAPORATOR FAN

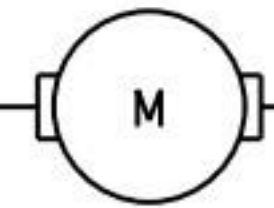
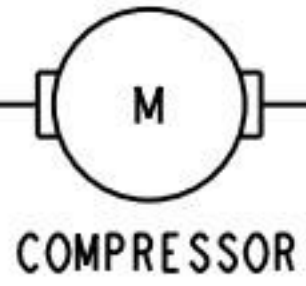
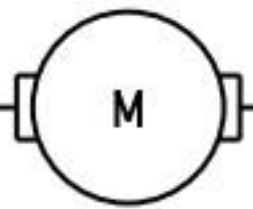

CONDENSOR FAN

LED DISPLAY
(IF USED)

EVAP COIL
SENSOR

CABINET AIR
SENSOR

115V/60Hz/1Ø

L1 G N

NEMA 5-15P
Supply Cord &
Plug Furnished

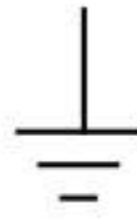

Black

White

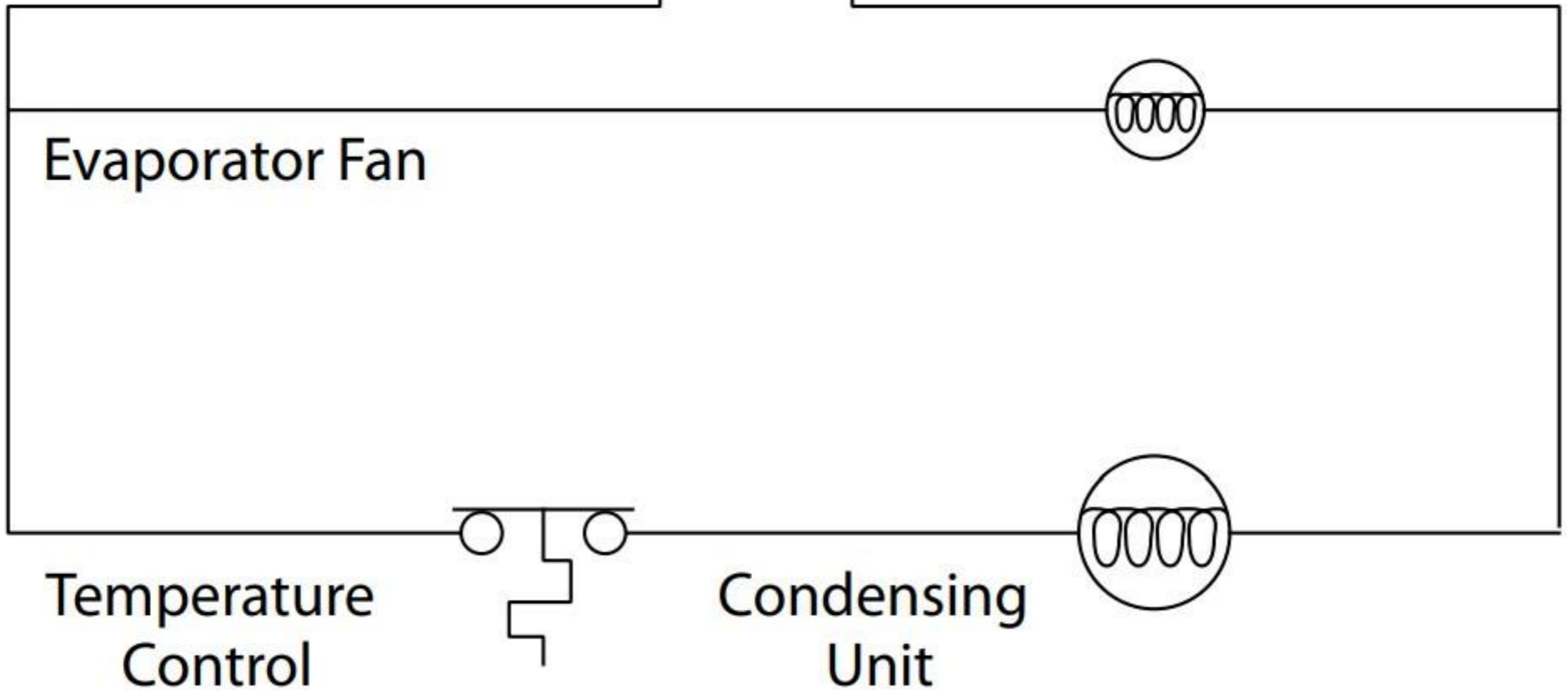

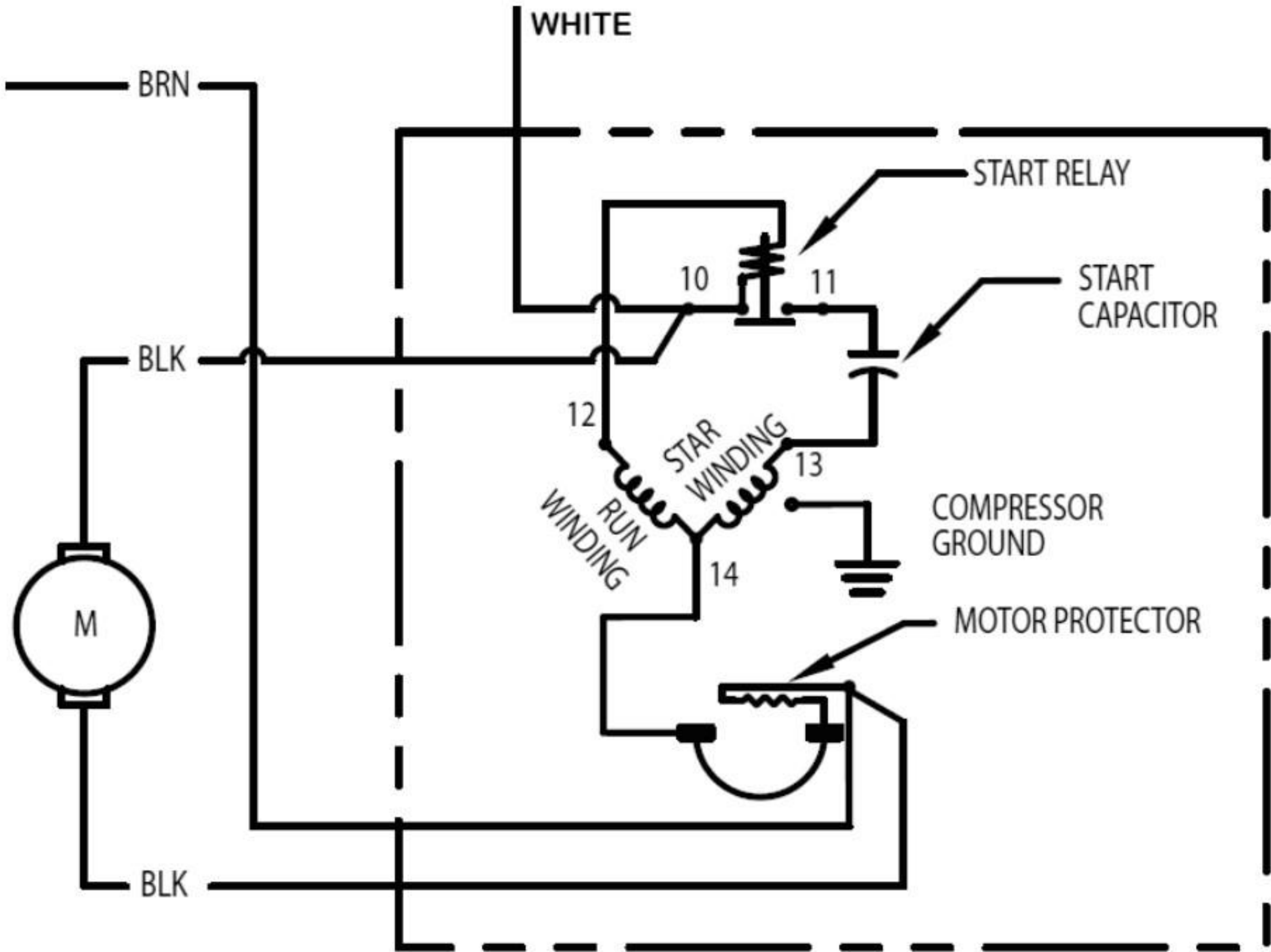

COMPRESSOR