

TOSHIBA

Carrier

AIR CONDITIONER (MULTI TYPE)

Installation manual



Indoor Unit

Model name:

Compact 4-way Cassette type

MMU-AP0071MH2UL

MMU-AP0091MH2UL

MMU-AP0121MH2UL

MMU-AP0151MH2UL

MMU-AP0181MH2UL



Installation manual
Air conditioner (Multi type)

1 English

Manuel d'installation
Climatiseur (Type multi)

18 Français

Please read this manual thoroughly before installation work and install the products correctly.

- This Manual describes the installation method of the indoor unit.
- For installation of the outdoor unit, refer to the Installation Manual of the outdoor unit.

ADOPTION OF NEW REFRIGERANT







This Air Conditioner uses R410A an environmentally friendly refrigerant.

Contents

1	Accessory Parts	1
2	Precautions for Safety	2
3	Selection of Installation Place	3
4	Installation	4
5	Drain Piping Work	7
6	Refrigerant Piping and Evacuation	8
7	Electrical Connection	9
8	Applicable Controls	12
9	Test Run	13
10	Troubleshooting	14

1 Accessory Parts

■ Accessory parts

Part name	Q'ty	Shape	Usage
Installation Manual	1	This manual	(Hand over to customers)
Heat insulating pipe	2		For heat insulation of pipe connecting section
Installation pattern	1	—	For confirmation of ceiling opening and indoor unit position
Installation gauge	2		For positioning of ceiling position
Pattern fixing screw	4	0.2" (5 mm) × 0.6" (16 mm)	For attach the installation pattern
Washer	8		For hanging-down unit
Hose band	1		For connecting drain pipe
Heat insulator	1		For heat insulation of drain connecting section
Heat insulator A	1		For sealing of control wire connecting port
Flexible hose	1		For adjusting center of drain pipe

■ Separate sold parts

- The Ceiling panel and remote control are sold separately. For the installation of these products, follow the Installation Manuals supplied with them.

2 Precautions for Safety

Installing, starting up, and servicing air-conditioning equipment can be hazardous due to system pressures, electrical components, and equipment location (roofs, elevated structures, etc.).

Only trained, qualified installers and service mechanics should install, start-up, and service this equipment.

Untrained personnel can perform basic maintenance functions such as cleaning heat exchanger. All other operations should be performed by trained service personnel.

Before working on the equipment, observe precautions in the literature and on tags, stickers, and labels attached to the equipment.

Follow all safety codes. Wear safety glasses and work gloves. Keep quenching cloth and fire extinguisher nearby during brazing. Use care in handling, rigging, and setting bulky equipment.

Read these instructions thoroughly and follow all warnings or cautions included in literature and attached to the unit. Consult local building codes and National Electrical Code (NEC) for special requirements. Recognize safety information. This is the safety-alert symbol . When you see this symbol on the unit and in instructions or manuals, be alert to the potential for personal injury. Understand these signal words: DANGER, WARNING, and CAUTION. These words are used with the safety-alert symbol.

DANGER identifies the most serious hazards which will result in severe personal injury or death. WARNING signifies hazards which could result in personal injury or death. CAUTION is used to identify unsafe practices which may result in minor personal injury or product and property damage. NOTE is used to highlight suggestions which will result in enhanced installation, reliability, or operation.

The manufacturer shall not assume any liability for the damage caused by not observing the description of this manual.

WARNING

- **Only a qualified installer or service person is allowed to do installation work.**
Inappropriate installation may result in water leakage, electric shock or fire.
- **Do not use any refrigerant different from the one specified for complement or replacement.**
Otherwise, abnormally high pressure may be generated in the refrigeration cycle, which may result in a failure or explosion of the product or an injury to your body.
- **Connect ground wire. (grounding work)**
Incomplete grounding may cause an electric shock.
Do not connect ground wires to gas pipes, water pipes, lightning rods or ground wires for telephone wires.
- **Turn off all the circuit breaker before attempting any electrical work.**
Failure to do so may cause electric shock.
- **Install the refrigerant pipe securely during the installation work before operating the air conditioner.**
If the air conditioner is operated with the valve open and without the refrigerant pipe, the compressor sucks air and the refrigeration cycle is overpressurized, which may cause a burst or injury.
- **When moving the air conditioner for the installation into another place, do not enter any gaseous matter other than the specified refrigerant into the refrigeration cycle.**
If air or any other gas is mixed in the refrigerant, the gas pressure in the refrigeration cycle becomes abnormally high and it resultingly causes pipe burst and injuries on persons.
- **Perform installation work properly according to the Installation Manual.**
Inappropriate installation may result in water leakage, electric shock or fire.
- **When the air conditioner is installed in a small room, provide appropriate measures to ensure that the concentration of refrigerant leakage occur in the room does not exceed the critical level.**
- **Install the air conditioner securely in a location where the base can sustain the weight adequately.**
- **Perform the specified installation work to guard against an earthquake.**
If the air conditioner is not installed appropriately, accidents may occur due to the falling unit.
- **If refrigerant gas has leaked during the installation work, ventilate the room immediately.**
If the leaked refrigerant gas comes in contact with fire, noxious gas may generate.
- **After the installation work, confirm that refrigerant gas does not leak.**
If refrigerant gas leaks into the room and flows near a fire source, such as a cooking range, noxious gas might generate.

- **Electrical work must be performed by a qualified electrician in accordance with the Installation Manual. Use an exclusive power supply for the air conditioner at the rated voltage.**
An insufficient power supply capacity or inappropriate installation may cause fire.
- **Use the specified wires for wiring connect the terminals. Securely fix them to prevent external forces applied to the terminals from affecting the terminals.**
- **Conform to the regulations of the local electric company when wiring the power supply.**
- **For the refrigerant recovery work (collection of refrigerant from the pipe to the compressor), stop the compressor before disconnecting the refrigerant pipe.**
If the refrigerant pipe is disconnected while the compressor is working with the valve open, the compressor sucks air and the refrigeration cycle is overpressurized, which may cause a burst or injury.

CAUTION

- **THIS AIR CONDITIONER ADOPTS THE NEW HFC REFRIGERANT (R410A) WHICH DOES NOT DESTROY OZONE LAYER.**
- The characteristics of R410A refrigerant are; easy to absorb water, oxidizing membrane or oil, and its pressure is approx. 1.6 times higher than that of refrigerant R22. Accompanied with the new refrigerant, refrigerating oil has also been changed. Therefore, during installation work, be sure that water, dust, former refrigerant, or refrigerating oil does not enter the refrigerating cycle.
- To prevent charging an incorrect refrigerant and refrigerating oil, the sizes of connecting sections of charging port of the main unit and installation tools are changed from those for the conventional refrigerant.
- Accordingly the exclusive tools are required for the new refrigerant (R410A).
- For connecting pipes, use new and clean piping designed for R410A, and please care so that water or dust does not enter.
- **Tighten the flare nut with a torque wrench in the specified manner.**
Excessive tightening of the flare nut may cause a crack in the flare nut after a long period, which may result in refrigerant leakage.
- **Wear heavy gloves during the installation work to avoid injury.**

3 Selection of Installation Place

⚠ WARNING

- **Install the air conditioner securely in a location where the base can sustain the weight adequately.**
If the strength is not enough, the unit may fall down resulting in injury.
- **Install the air conditioner at a height 8' (2.4 m) or more from the floor.**
If you insert your hands or others directly into the unit while the air conditioner operates, it is dangerous because you may contact with revolving fan or active electricity.

⚠ CAUTION

- **Do not install in a location where flammable gas may leaks are possible.**
If the gas leak and accumulate around the unit, it may ignite and cause a fire.

Upon approval of the customer, install the air conditioner in a place that satisfies the following conditions.

- Place where the unit can be installed horizontally.
- Place where a sufficient servicing space can be ensured for safety maintenance and check.
- Place where drained water will not cause any problem.

Avoid installing in the following places.

- Place exposed to air with high salt content (seaside area), or place exposed to large quantities of sulfide gas (hot spring).
(The unit should be used in these places, special protective measures are needed.)
- A restaurant kitchen where a lot of oil is used or place near machines in a factory (Oil adhering to the heat exchanger and resin part (turbo fan) in the indoor unit may reduce the performance, generate mist or dew drop, or deform or damage resin parts.)
- Place where organic solvent is used nearby.
- Place close to a machine generating high frequency.
- Place where the discharged air blows directly into the window of the neighbor house. (Outdoor unit)
- Place where noise of the outdoor unit is easily transmitted.
(When the outdoor unit is installed on the boundary with the neighbor, pay due attention to the level of noise.)
- Place with poor ventilation. (Before air duct work, check whether value of fan speed, static pressure and duct resistance are correct.)
- Do not use the air conditioner for special purposes such as preserving food, precision instruments, or art objects, or where breeding animals or growing plants are kept. (This may degrade the quality of preserved materials.)
- Place where any of high-frequency appliances (including inverter devices, private power generators, medical equipment, and communication equipment) and inverter-type fluorescent light is installed.
(A malfunction of the air conditioner, abnormal control, or problems due to noise to such appliances/equipment may occur.)
- When the wireless remote control is used in a room equipped with an inverter-type fluorescent light or at a place exposed to direct sunlight, signals from the remote control may not be received correctly.
- Place where organic solvent is used.
- Place near a door or window exposed to humid outside air (Dew drop may form.).
- Place where special spray is used frequently.

■ Installation space

Ensure there is sufficient space to install the unit and to perform maintenance work as and when required. Keep 0.6" (15mm) or more for clearance between top plate of the indoor unit and the ceiling surface.

unit: in (mm)

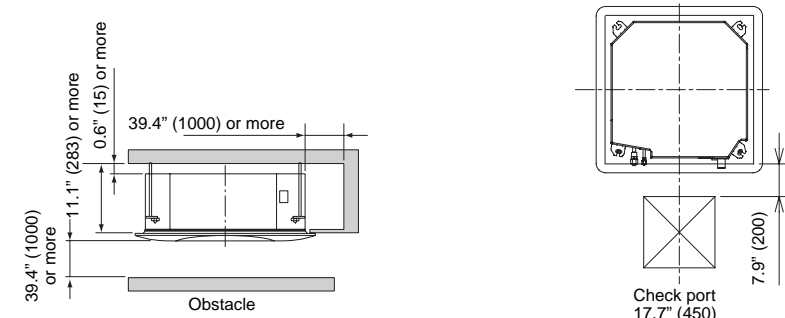

■ Selection of installation place

Continual operation of the indoor unit under high-humidity conditions as described below, dew may condense and water may drop.

Especially, high-humidity atmosphere (dew point temperature: 73.4°F (23°C) or more) may generate dew inside the ceiling.

1. Unit is installed inside the ceiling with slated roof.
2. Unit is installed at a location using inside of the ceiling as fresh air take-in path.
3. Kitchen

Advice

- Set a service check opening panel at right side of the unit (size: 17.7" × 17.7" (450 × 450mm) or more) for piping, maintenance, and servicing.
- If installing a unit at such place, put insulating material (glass wool, etc.) additionally on all the positions of the indoor unit which come to contact with high-humidity atmosphere.

REQUIREMENT

When the humidity inside the ceiling seems to be higher than 80%, attach a heat insulator to the side (top) surface of the indoor unit. (Use a heat insulator that is 0.4" (10 mm) or more thick.)

■ Ceiling height

Model MMU-	Installable ceiling height	Unit : ft (m)
AP007 to AP012 type	Up to 8'10" (2.7 m)	
AP015 to AP018 type	Up to 11'6" (3.5 m)	

When the height of the ceiling exceeds the distance of the item Standard/4-way in below table, the warm air is difficult to reach the floor.

It is necessary to change the setup value of the high ceiling setting or discharge direction.

▼ Height list of ceiling possible to be installed

Indoor unit Capacity type	AP007 to AP012 type	AP015 type	AP018 type	Setup of high ceiling	Unit : ft (m)
Discharge direction	4-way	4-way	4-way	Setup data	
Standard (At shipment)	8'10" (2.7m)	9'6" (2.9m)	10'6" (3.2m)	0000	
High ceiling (2)	—	10'6" (3.2m)	11'2" (3.4m)	0002	
High ceiling (3)	—	11'6" (3.5m)	11'6" (3.5m)	0003	

REQUIREMENT

- When high ceiling (2) or (3) is used with 4-way blowing, a draft is easily recognized due to drop of discharge temperature.

The lighting time of the filter sign (notification of filter cleaning) on the remote control can be changed according to installation conditions.

When it is difficult to obtain satisfactory heating due to location place of the indoor unit or the structure of the room, the detection temperature of heating can be raised.

Refer to "8. Applicable Controls" in this manual for the setting procedure.

4 Installation

⚠ WARNING

The installation of the air conditioning unit must be positioned in a location that can sufficiently support its weight and give protection against adverse environmental conditions.

Failure to do so may result in unit damage and possible human injury.

Any incomplete installation may also cause possible risk of human injury.

- Unpack the package, take out the product and then place it on the floor so that the same surface directs underneath as it is placed in the package.

If the both sides are turned over, a deformation of mounting metal of the ceiling panel which is sold separately may be caused.

Accordingly the product may be damaged and the installation becomes impossible in some cases.

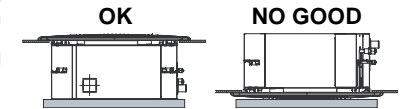

REQUIREMENT

Strictly comply with the following rules to prevent damage of the indoor units and human injury.

- Do not put a heavy article on the indoor unit. (Even units are packaged)
- Carry in the indoor unit as it is packaged if possible. If carrying in the indoor unit unpacked by necessity, use buffering cloth or other soft cloth to not damage the unit.
- To move the indoor unit, hold the hooking metals (4 positions) only. Do not apply force to the other parts (refrigerant pipe, drain pan, foamed parts, or resin parts).
- Carry the package by two or more persons, and do not bundle it with plastic band at positions other than specified.

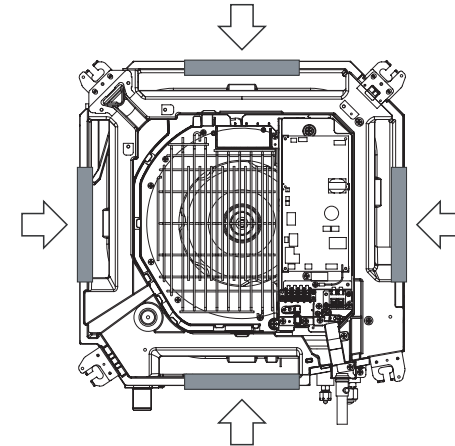

⚠ CAUTION

Do not tear off the tape adhered to the cabinet; otherwise vibration is caused from the cabinet.

External view

Unit: in (mm)

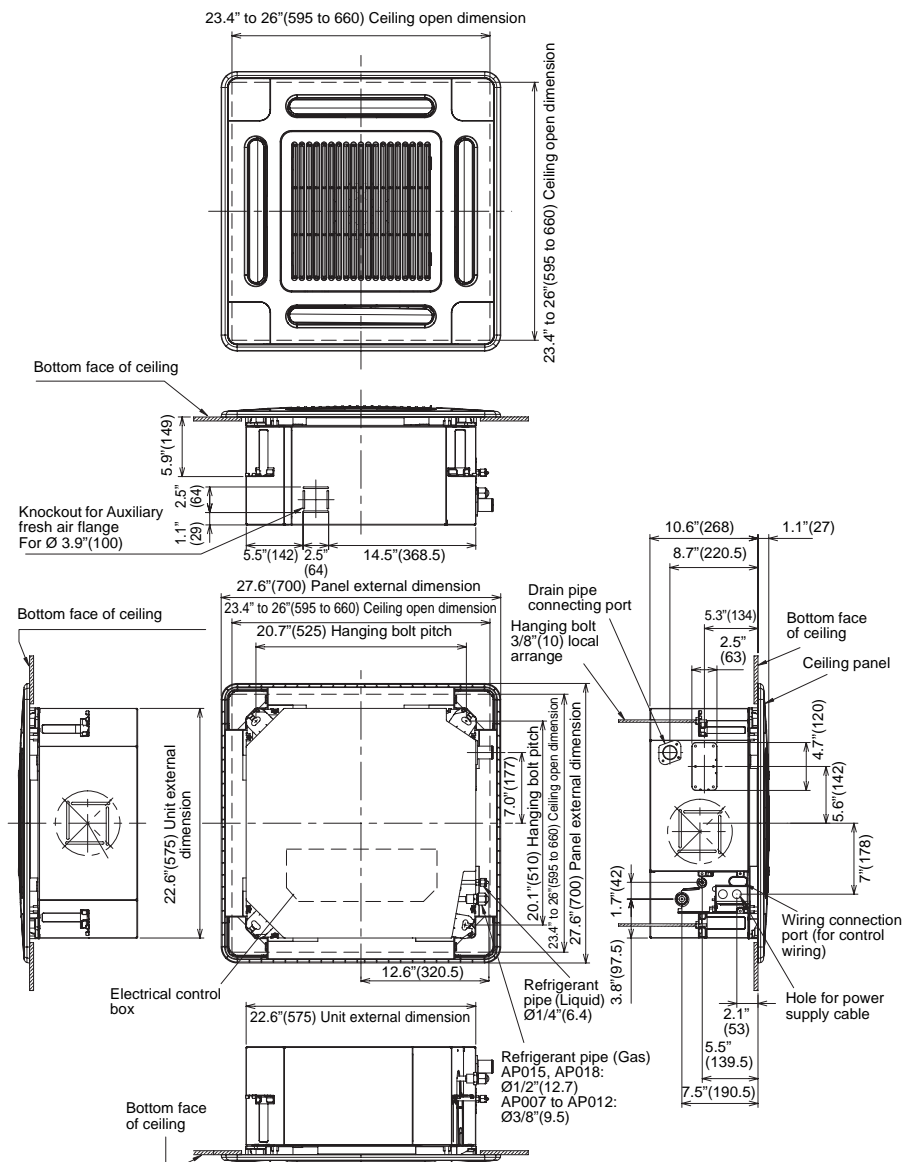

Opening a ceiling and installation of hanging bolts

- Consider the piping/wiring after the unit is hung to determine the location of the indoor unit installation and orientation.
- After the location of the indoor unit installation has been determined, open the ceiling and install hanging bolts.
- The dimensions of the ceiling opening and hanging bolt pitches are given in the outline drawing and the attached installation pattern.
- When a ceiling already exists, lay the drain pipe, refrigerant pipe, control wires, and remote control wires to their connection locations before hanging the indoor unit.

Procure hanging bolts and nuts for installing the indoor unit (these are not supplied).

Hanging bolt	3/8" (M10)	4 pieces
Nut	3/8" (M10)	12 pieces

Using the installation pattern (accessory)

The installation pattern is provided inside the packaging cap.

<For existing ceiling>

Use the installation pattern positioning a ceiling opening and hanging bolts.

<For new ceiling>

Use the installation pattern to position the ceiling opening when a ceiling is hanged.

- After the hanging bolts have been installed, install the indoor unit.
- To use the supplied pattern attach it to the indoor unit using the supplied fixing screws (0.2" (5mm) x 0.6" (16mm) 4 pcs.). (Screw pattern to the ceiling panel hanging brackets of the indoor unit)
- Before hanging a ceiling, open the ceiling along the outside dimensions of the installation pattern.

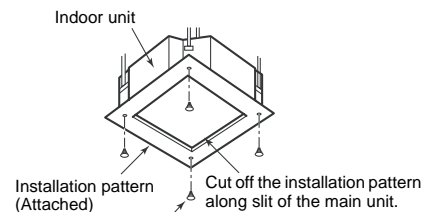

0.2" (5mm) x 0.6" (16mm) screws (Attached)

(These screws are exclusive to the installation pattern. When installing the ceiling panel, the other exclusive screws attached to the ceiling panel (sold separately) are used.)

Treatment of ceiling

The ceiling differs according to structure of building. For details, consult your constructor or interior finish contractor.

In the process after the ceiling board has been removed, it is important to reinforce ceiling foundation (frame) and to keep horizontal level of installed ceiling correctly in order to prevent vibration of ceiling board.

1. Cut and remove the ceiling foundation.
2. Reinforce the cut surface of ceiling foundation, and add ceiling foundation for fixing the end of ceiling board.

Installation of hanging bolt

Use 3/8" (M10) hanging bolts (4 pcs, to be local procure). Matching to the existing structure, set pitch according to size in the unit external view as shown below.

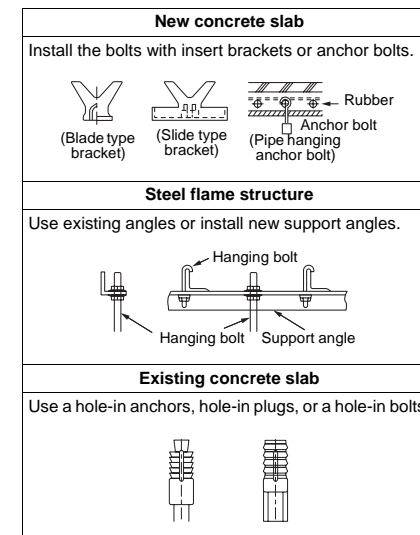

Installation of ceiling opening and hanging bolt

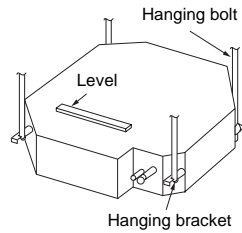

- Attach a nut (3/8" (M10): not supplied) and the Ø1.3" (34 mm) washer (supplied) to each hanging bolt.
 - Insert a washer on both sides of the T groove of the hanging bracket of the indoor unit, and hang the indoor unit.
 - Check that the four sides of the indoor unit are level using a level vial (levelness: 0.2" (5 mm) or less).
 - Detach the installation gauge (accessory) from the installation pattern.
 - Using the installation gauge, check and adjust the positional relation between the indoor unit and the ceiling opening (1) (0.4" - 1.7" (10 - 42 mm): 4 sides) and the hanging-up height (2) (0.9" - 1.1" (23 - 28 mm): 4 corners).
- (How to use the installation gauge is printed on the gauge.)

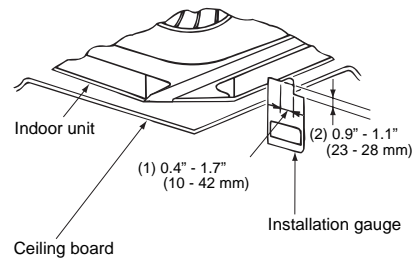
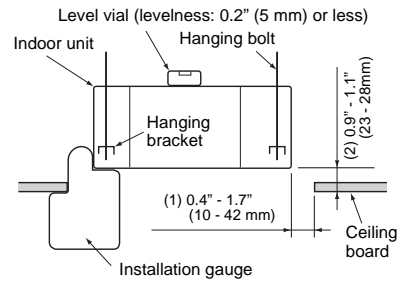
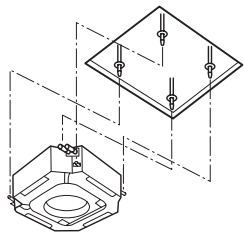
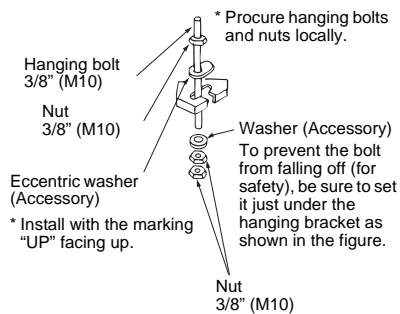

CAUTION

Before installation of the indoor unit, remove the tape that holds the fan and bell mouth. Running the unit without removing the tape may damage the fan motor.

Installation of ceiling panel (sold separately)

Install the ceiling panel according to Installation Manual attached with it after piping/wiring work has completed.

Check that installation of indoor unit and ceiling opening part is correct, and then install it.

REQUIREMENT

- Joint the connecting sections of ceiling panel, ceiling surface, ceiling panel and indoor unit closely. Any gap between them will cause air leakage and the generate condensation or water leakage.
- Remove the adjust corner caps at the four corners of the ceiling panel, and then install the ceiling panel onto the indoor unit.

Installation of remote control (Sold separately)

For installation of the wired remote control, follow the Installation Manual attached with the remote control.

- Pull out the remote control cord together with the refrigerant pipe or drain pipe. Pass the remote control cord through upper side of the refrigerant pipe and drain pipe.
- Do not leave the remote control at a place exposed to the direct sunlight and near a stove.

Wireless remote control

The sensor of indoor unit with wireless remote control can receive a signal by distance within approx. 26.2" (8 m). Based upon it, determine a place where the remote control is operated and the installation place.

- Operate the remote control, confirm that the indoor unit receives a signal surely, and then install it.
- Keep 3'3" (1 m) or more from the devices such as television, stereo, etc. (Disturbance of image or noise may generate.)
- To prevent a malfunction, select a place where is not influenced by a fluorescent light or direct sunlight.
- Two or more (Up to 6 units) indoor units with wireless type remote control can be installed in the same room.

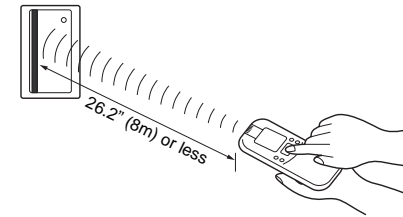

5 Drain Piping Work

CAUTION

- Following the Installation Manual, perform the drain piping work so that water is properly drained, and apply a heat insulation so as not to cause a dew drop. Inappropriate piping work may result in water leakage in the room and wet of furniture.

Piping/Heat insulating material

Require the following materials for piping and heat insulating at site.

Piping	Hard vinyl chloride pipe VP25 (Outer dia.: $\varnothing 1.3$ " (32 mm))
Heat insulator	Foam polyethylene: Thickness 0.4" (10 mm) or more

Flexible hose

Use the attached flexible hose to adjust center discrepancy of the hard vinyl chloride pipe or to adjust the angle.

- Do not use the flexible hose as stretched, or do not deform it more extent than that in the following figure.
- Fix the soft end of the flexible hose with the attached hose band.
- Use the flexible hose on a horizontal level.

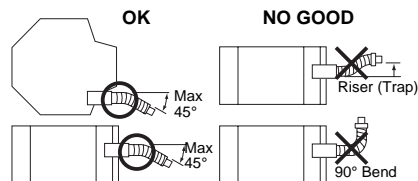

REQUIREMENT

- Perform heat insulation of the drain pipes of the indoor unit.
- Perform heat insulation of the connecting part with the indoor unit. An incomplete heat insulation causes dew drop.
- Set the drain pipe with downward slope (1/100 or more), and do not make swelling or trap on the piping. It may cause an abnormal sound.
- For length of the traversing drain pipe, restrict to 65'7" (20 m) or less.

In case of a long pipe, provide support brackets with interval of 4'11" - 6'7" (1.5 - 2 m) in order to prevent waving.

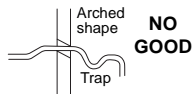
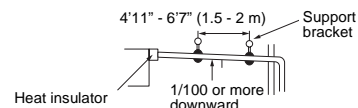

- Set the collective piping as shown in the below figure.

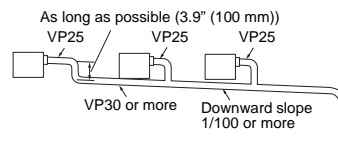

- Do not apply force to the connecting part of the drain pipe.
- The hard vinyl-chloride pipe cannot be directly connected to the drain pipe connecting port of the indoor unit.

For connection with the drain pipe connecting port, fix the attached flexible hose with the hose band, otherwise a damage or water leak is caused on the drain pipe connecting port.

Drain up

When a down-gradient cannot be secured for the drainpipe, drain-up piping is possible.

- The height of the drain pipe must be 33.5" (850 mm) or less from the bottom of the ceiling.
- Take the drain pipe out of the drain pipe joint with the indoor unit in 11.8" (300 mm) or less, and bend up the pipe vertically.
- Immediately after the pipe is bent up vertically, lay the pipe making a down-gradient.
- Set downward grading immediately after raising up vertically.

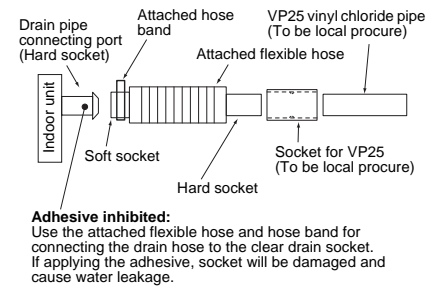

Adhesive inhibited:

Use the attached flexible hose and hose band for connecting the drain hose to the clear drain socket. If applying the adhesive, socket will be damaged and cause water leakage.

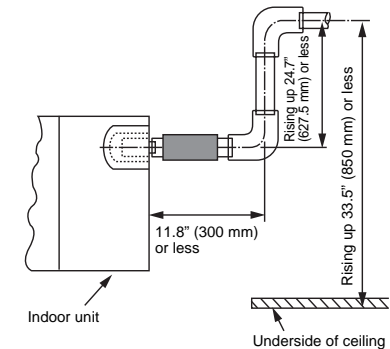
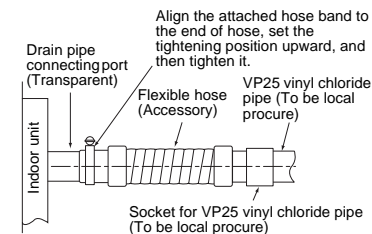

Connecting drain pipe

- Connect a hard socket (procured locally) to the hard socket of the attached supplied flexible hose.
- Connect a drain pipe (procured locally) to the connected hard socket.

REQUIREMENT

- Connect hard vinyl chloride pipes securely using an adhesive for vinyl chloride to avoid water leakage.
- It takes some time until the adhesive is dried and hardened (refer to the manual of the adhesive). Do not apply stress to the joint with the drain pipe during this time period.

Check the draining

In the test run, check that water drain is properly performed and water does not leak from the connecting part of the pipes.

Check draining also when installed in heating period. By using a pitcher or hose, pour water (0.4 - 0.5 gal (1500 - 2000 cc)) into the discharge port before installation of the ceiling panel.

Pour water gradually so that water does not spread on the motor of the drain pump.

CAUTION

Pour water gently so that it does not spread around inside the indoor unit, which may cause a malfunction.

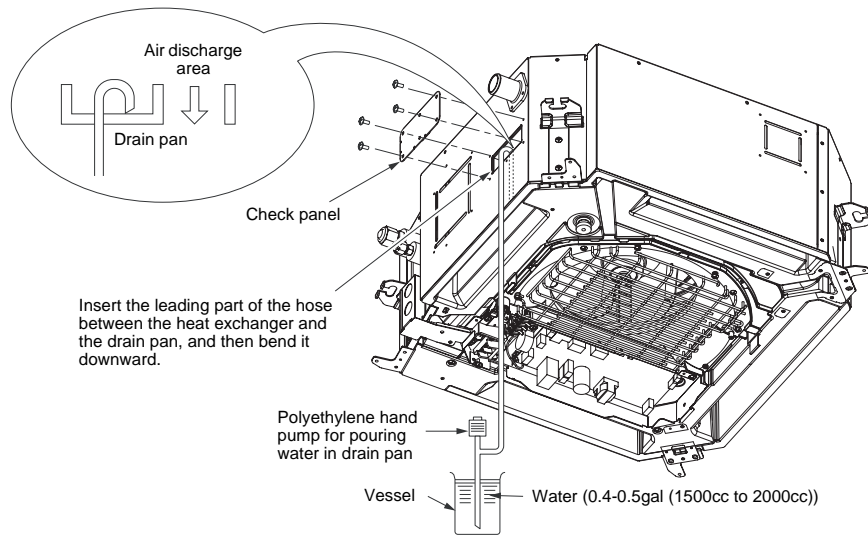

- After the electric work has finished, pour water during COOL mode operation.
- If the electric work has not yet finished, pull out the float switch connector (CN34: Red) from the electrical control box, and check draining by plugging the single phase 208/230 V power to the terminal blocks L1 and L2. If doing so, the drain pump motor operates.
- Test water drain while checking the operation sound of the drain pump motor. (If the operation sound changes from continuous sound to intermittent sound, water is normally drained.) After the check, the drain pump motor runs, connecting the float switch connector. (In case of check by pulling out the float switch connector, be sure to return the connector to the original position.)

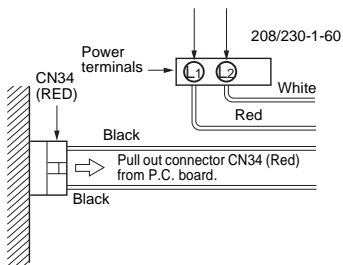

■ Perform heat insulating

- As shown in the figure, cover the flexible hose and hose band with the attached heat insulator up to the bottom of the indoor unit without gap.
- Cover the drain pipe seamlessly with a heat insulator to be procured locally so that it overlaps with the attached heat insulator of the drain connecting section.

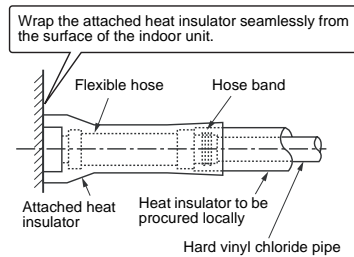

* Direct the slits and seams of the heat insulator upward to avoid water leakage.

6 Refrigerant Piping and Evacuation

■ Refrigerant Piping

1. Use copper pipe with 0.03" (0.8 mm) or more thickness.
2. Flare nut and flare works are also different from those of the conventional refrigerant. Take out the flare nut attached to the main unit of the air conditioner, and use it.

REQUIREMENT

When the refrigerant pipe is long, provide support brackets at intervals of 8'2" - 9'10" (2.5 - 3 m) to clamp the refrigerant pipe. Otherwise, abnormal sound may be generated.

⚠ CAUTION

IMPORTANT 4 POINTS FOR PIPING WORK

1. Remove dust and moisture from the inside of the connecting pipes.
2. Tight connection (between pipes and unit)
3. Evacuate the air in the connecting pipes by using VACUUM PUMP.
4. Check the gas leakage. (Connected points)

■ Pipe size

Model name	MMU-	AP007, AP009, AP012 type	AP015, AP018 type
Pipe size	Gas side	3/8" (9.5 mm)	1/2" (12.7 mm)
	Liquid side	1/4" (6.4 mm)	1/4" (6.4 mm)

■ Permissible Piping Length and Height Difference

They vary according to the outdoor unit. For details, refer to the Installation Manual attached to the outdoor unit.

Flaring

- Cut the pipe with a pipe cutter. Remove burrs completely. Remaining burrs may cause gas leakage.
- Insert a flare nut into the pipe, and flare the pipe. As the flaring sizes of R410A differ from those of refrigerant R22, the flare tools newly manufactured for R410A are recommended.

However, the conventional tools can be used by adjusting projection margin of the copper pipe.

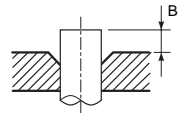

▼ Projection margin in flaring: B (Unit: in (mm))

Rigid (Clutch type)

Outer dia. of copper pipe	R410A tool used	Conventional tool used
	R410A	R410A
1/4" (6.4), 3/8" (9.5)	0 - 0.02" (0 - 0.5)	0.04" - 0.06" (1.0 - 1.5)
1/2" (12.7)		

▼ Flaring dia. meter size: A (Unit: in (mm))

Outer dia. of copper pipe	A ⁺⁰ / _{-0.02 (0.4)}
	R410A
1/4" (6.4)	0.36" (9.1)
3/8" (9.5)	0.52" (13.2)
1/2" (12.7)	0.65" (16.6)

* In case of flaring for R410A with the conventional flare tool, pull it out approx. 0.02" (0.5 mm) more than that for R22 to adjust to the specified flare size. The copper pipe gauge is useful for adjusting projection margin size.

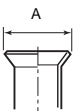

Tightening connection**⚠ CAUTION**

- Do not apply excessive torque. Otherwise, the nut may crack depending on the conditions.

Unit: ft•lbs (N•m)	
Outer dia. of copper pipe	Tightening torque
1/4" (6.4 mm)	10 - 13 (14 - 18)
3/8" (9.5 mm)	24 - 31 (33 - 42)
1/2" (12.7 mm)	37 - 46 (50 - 62)

▼ Tightening torque of flare pipe connections

Pressure of R410A is higher than that of R22. (Approx. 1.6 times) Use a torque wrench, tighten the flare pipe connecting sections which connect the indoor and outdoor units of the specified tightening torque.

Incorrect connections may cause not only a gas leak, but also a trouble of the refrigeration cycle. Align the centers of the connecting pipes and tighten the flare nut as far as possible with your fingers. Then tighten the nut with a spanner and torque wrench as shown in the figure.

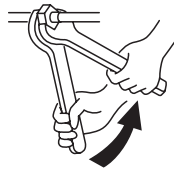

Work using double spanner

REQUIREMENT

Tightening with an excessive torque may crack the nut depending on installation conditions. Tighten the nut within the specified tightening torque.

Piping with outdoor unit

- Shape of valve differs according to the outdoor unit. For details of installation, refer to the Installation Manual of the outdoor unit.

Leak check test, evacuation and other procedure

For leak check test, evacuation, addition of refrigerant, and gas leak check, refer to the Installation Manual attached to the outdoor unit.

REQUIREMENT

Do not supply power to the indoor unit until the leak check test and evacuation are completed. (If the indoor unit is powered on, the pulse motor valve is fully closed, which extends the time for vacuuming.)

Open the valve fully

Open the valve of the outdoor unit fully. For details, refer to the Installation Manual attached to the outdoor unit.

Heat insulation process

Apply heat insulation for the pipes separately at liquid side and gas side.

For the heat insulation to the pipes at gas side, use the material with heat-resisting temperature 248 °F (120 °C) or higher.

Apply the attached heat insulation to the pipe connecting section of the indoor unit securely without gap.

REQUIREMENT

- Apply the heat insulation to the pipe connecting section of the indoor unit securely up to the root without exposure of the pipe. (The pipe exposed to the outside may cause water leak.)
- Wrap heat insulator with its slits facing up (ceiling side).

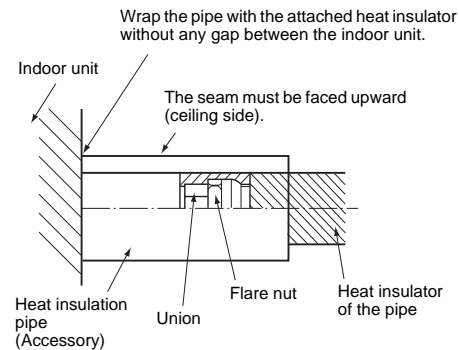
**7 Electrical Connection****⚠ WARNING**

- Use predefined wire and connect them certainly. Keep the connecting terminal free from external force.**
Improper wire connection or clamping may result in exothermic, fire or malfunction.
- Connect ground wire. (grounding work)**
Incomplete grounding cause an electric shock. Do not connect ground wires to gas pipes, water pipes, lightning rods or ground wires for telephone wires.
- Install appliance in accordance with national wiring regulations.**
Capacity shortage of circuit breaker or incomplete installation may cause an electric shock or a fire.

⚠ CAUTION

- Consult local building codes, NEC (National Electrical Code) or CEC (Canadian Electrical Code) for special requirements.
- If incorrect/incomplete wiring is carried out, it will cause an electrical fire or smoke.
- Install circuit breaker is not tripped by shock waves. If circuit breaker is not installed, an electric shock may be caused.
- Use the cord clamps attached to the product.
- Do not damage or scratch the conductive core and inner insulator of power and control wires when peeling them.
- Use the power cord and control wire of specified thickness, type, and protective devices required.
- Do not connect 208/230 V power to the terminal blocks (U1, U2, A, B etc.) for control wiring. (Otherwise, the system will fail.)
- Perform the electric wiring so that it does not come to contact with the high-temperature part of the pipe. The coating may melt resulting in an accident.
- Do not turn on the circuit breaker of the indoor unit until vacuuming of the refrigerant pipes completes.

REQUIREMENT

- For power supply wiring, strictly conform to the Local Regulation in each country.
- Run the refrigerant piping line and control wiring line in the same line.

Power supply wire and control wires specifications

Power supply wire and control wires are procured locally.

For the power supply specifications, follow to the table below. If capacity is little, it is dangerous because overheat or seizure may be caused.

Indoor unit power supply

- For the power supply of the indoor unit, prepare the exclusive power supply separated from that of the outdoor unit.

▼ Power supply

Power supply	208/230-1-60
--------------	--------------

Control wiring, Central control wiring

- 2-core with non-polarity wires are used for the control wiring between indoor unit and outdoor unit and Central control wiring.
- To prevent noise trouble, use 2-core shielded wire.
- The length of the communication line means the total length of the control wire length between indoor and outdoor units added with the central control wire length.

Power supply wire

- Recommended wire diameter and wire length for power supply wire.

Power supply wiring	Wire size: 2 × AWG12 Ground 1 × AWG12 or thicker	Up to 164'1" (50m)
---------------------	---	--------------------

▼ Electric characteristics

MCA : Minimum Circuit Amps
MOCP : Maximum Overcurrent Protection (Amps)

Model	Power Supply	Voltage Range (V)		MCA (A)	MOCP (A)
		Min	Max		
MMU-AP0071MH2UL	208/230V-1-60Hz	187	253	0.5	15
MMU-AP0091MH2UL				0.5	15
MMU-AP0121MH2UL				0.5	15
MMU-AP0151MH2UL				0.7	15
MMU-AP0181MH2UL				0.7	15

Control wire

Control wiring between indoor units, and outdoor unit (2-core shielded wire)	Wire size	(Up to 3280'10" (1000m)) AWG16 (Up to 6561'8" (2000m)) AWG14
--	-----------	---

Remote control wiring

- 2-core with non-polarity wire is used for wiring of the remote control wiring and group remote controls wiring.

Remote control wiring, remote control inter-unit wiring	Wire size: AWG20	
Total wire length of remote control wiring and remote control inter-unit wiring = L + L1 + L2 + ... Ln	In case of wired type only	Up to 1640'5" (500m)
	In case of wireless type included	Up to 1312'4" (400m)
Total wire length of remote control inter-unit wiring = L1 + L2 + ... Ln		Up to 656'2" (200m)

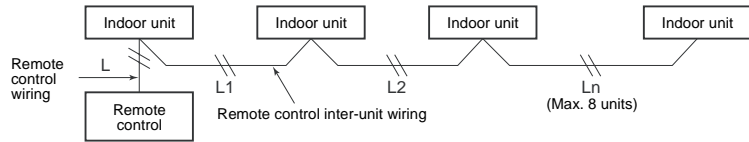

NOTE

- Use copper supply wire.
- Use UL wire rated 600V for the power supply.
- Use UL wire rated 300V for the remote control wires and control wires.

⚠ CAUTION

The remote control wire (Communication line) and AC208/230V wires cannot be parallel to contact each other and cannot be stored in the same conduits. If doing so, a trouble may be caused on the control system due to noise or other factor.

■ Wiring between indoor and outdoor units

NOTE

An outdoor unit connected with control wiring between indoor and outdoor units wire becomes automatically the header outdoor unit.

▼ Wiring example

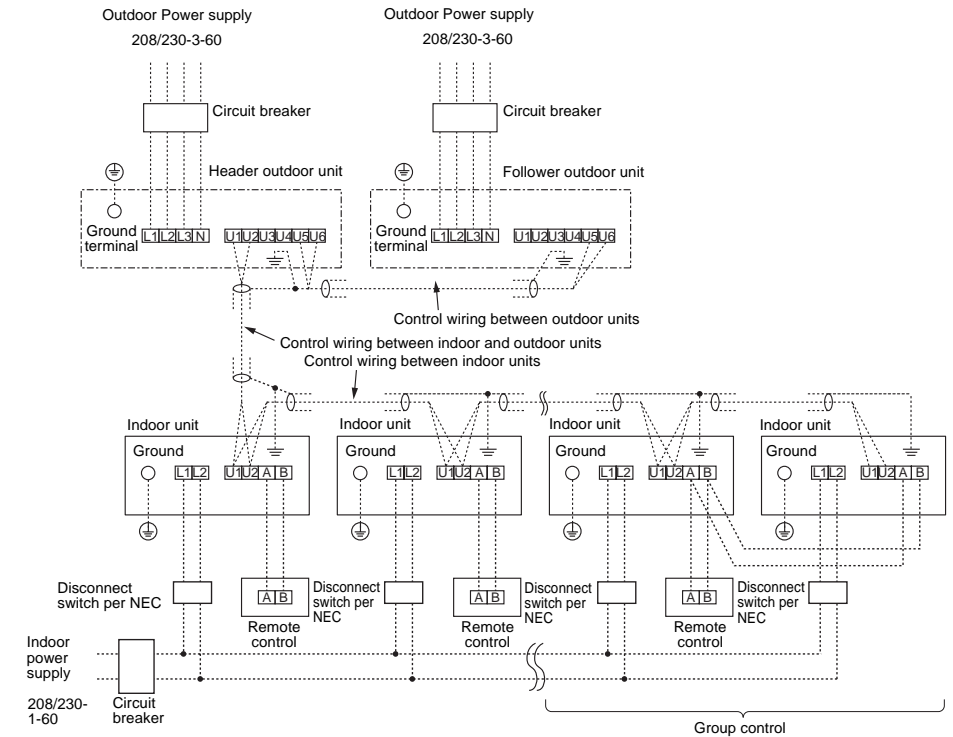

■ Wire connection

REQUIREMENT

- Connect the wires matching the terminal numbers. Incorrect connection causes a trouble.
 - Route the wire through the wire connection port of the indoor unit.
 - The low-voltage circuit is provided for the control wire and remote control wire. (Do not connect the high-voltage circuit.)
1. Remove the cover of the electrical control box by removing the mounting screws (3 positions) and push the hooking section. (The cover of the electrical control box remains hanged to the hinge.)
 2. Remove the wire cover by removing the mounting screws. (1 position)
 3. Remove the conduit plate B by removing the mounting screws. (1 position)
 4. Attach the conduit pipe to the conduit plate A with a lock nut.
 5. Tighten the screws on the terminal block and secure the wires with cord clamp fitted to the electrical control box. (Do not apply tension to the connecting section of the terminal block.)
 6. Use the supplied heat insulation for the sealing of the control wire connecting port. (Otherwise dew condensation may be caused.)
 7. Mount the conduit plate B, the wire cover and the cover of the electrical control box ensuring the wires are not pinched. (Mount the conduit plate B, the wire cover and the cover after the ceiling panel has been wired to the electrical control box.)

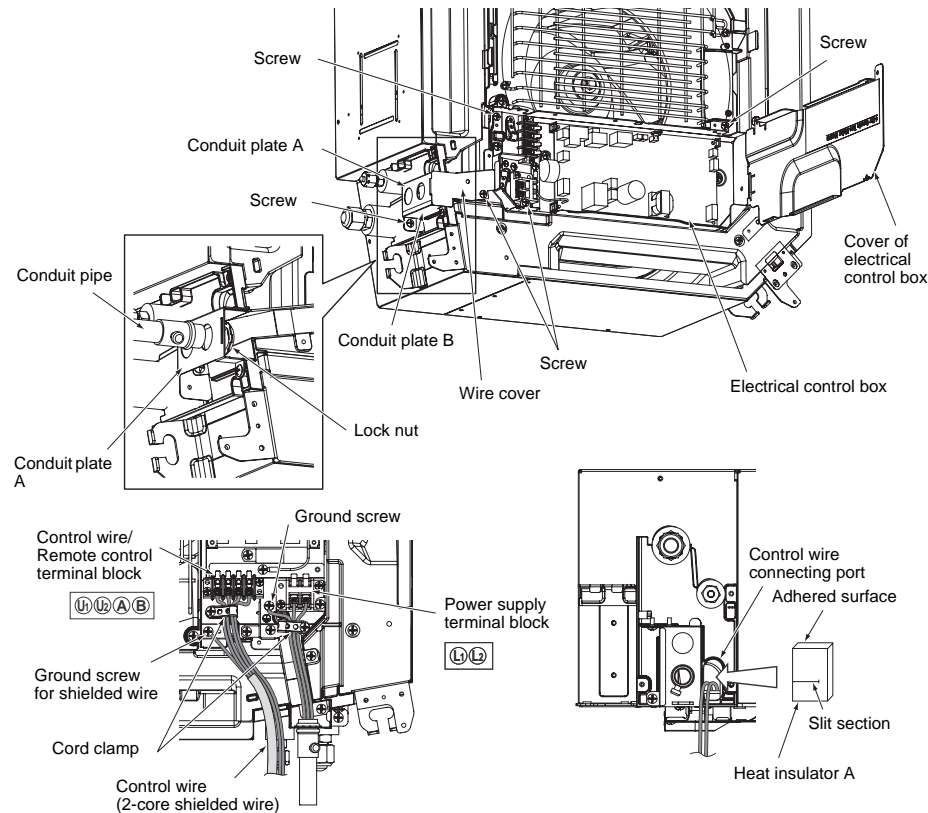

■ Power supply wires and ground wire

1. Strip the wire ends.
Power supply wire: 0.4" (10 mm)
Ground wire: 0.8" (20 mm)
2. Match the wire colors with the terminal numbers on the indoor units' and circuit breakers' terminal blocks and firmly screw the wires to the corresponding terminals.
3. Secure the ground wire with the ground screw.
4. Fix the wires with a cord clamp.

Unit: in (mm)

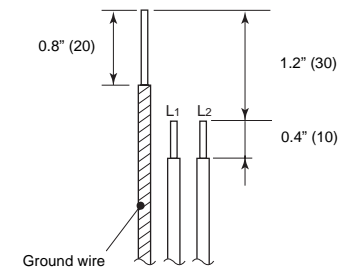

⚠ CAUTION

Firmly tighten the screws of the terminal block.

Keep the wire length as shown in figure below when it is connected to the terminal block.

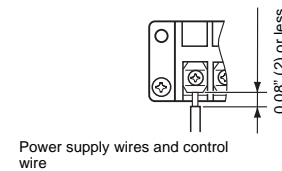

■ Wiring on the ceiling panel

According to the Installation Manual of the ceiling panel, connect the connector (2P: Red) of the ceiling panel to the connector (5P: White) on P.C. board of the electrical control box.

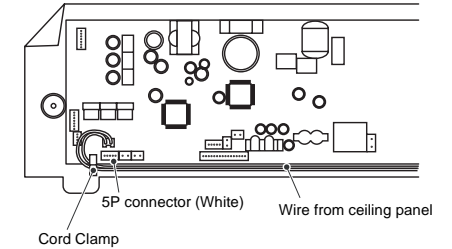

■ Address setup

Set up the addresses as per the Installation Manual supplied with the outdoor unit.

8 Applicable Controls

REQUIREMENT

- When this air conditioner is used for the first time, it takes approx. 5 minutes until the remote control becomes available after power-on. This is normal. **<When power is turned on for the first time after installation>** It takes approx. 5 to 10 minutes until the remote control becomes available.

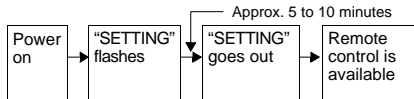

<When power is turned on for the second (or later) time>

It takes approx. 3 to 10 minutes until the remote control becomes available.

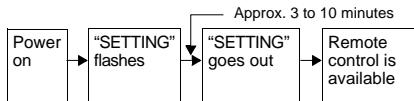

- Normal settings were made as factory default. Change the indoor unit settings as required.
- Use the wired remote control to change the settings.
 - * The settings cannot be changed using the wireless remote control, simple wired remote control, or central control system. Therefore, install the wired remote control to change the settings.

Changing applicable control setting

Basic procedure for changing settings

Change the settings while the air conditioner is not working.

(Stop the air conditioner before making settings.)

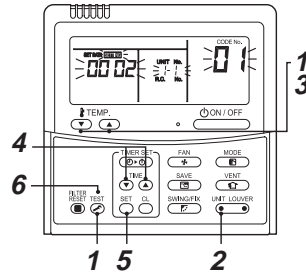

Procedure 1

Push **TEST** button and temp. setup button simultaneously for 4 seconds or more.

After a while, the display flashes as shown in the figure. Confirm that the CODE No. is [01].

- If the CODE No. is not [01], push **TEST** button to erase the display content, and repeat the procedure from the beginning. (No operation of the remote control is accepted for a while after **TEST** button is pushed.) (While air conditioners are operated under the group control, "ALL" is displayed first. When **UNIT LOUVER** button is pushed, the indoor unit number displayed following "ALL" is header unit.)

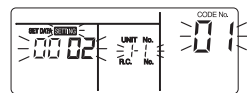

(* Display content varies with the indoor unit model.)

Procedure 2

Each time **UNIT LOUVER** button is pushed, indoor unit numbers in the control group change cyclically. Select the indoor unit to change settings for.

The fan of the selected unit runs and the louvers start swinging. The indoor unit can be confirmed for which to change settings.

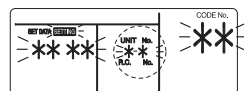

Procedure 3

Specify CODE No. [** *] with temp. setup button / **TEST** buttons.

Procedure 4

Select SET DATA [* * * *] with timer time button / **TEST** buttons.

Procedure 5

Push **SET** button. When the display changes from flashing to lit, the setup is completed.

- To change settings of another indoor unit, repeat from Procedure 2.
- To change other settings of the selected indoor unit, repeat from Procedure 3. Use **SET** button to clear the settings. To make settings after **SET** button was pushed, repeat from Procedure 2.

Procedure 6

When settings have been completed, push **TEST** button to determine the settings.

When **TEST** button is pushed, "SETTING" flashes and then the display content disappears and the air conditioner enters the normal stop mode. (While "SETTING" is flashing, no operation of the remote control is accepted.)

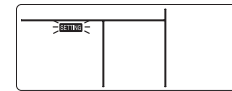

Installing indoor unit on high ceiling

When an indoor unit is installed on a ceiling higher than the standard height, make the high-ceiling setting for fan speed adjustment.

Follow to the basic operation procedure (1 -> 2 -> 3 -> 4 -> 5 -> 6).

- For the CODE No. in Procedure 3, specify [5d].
- Select the SET DATA for Procedure 4 from the "Height list of ceiling possible to be installed" table on page 4 in this manual.

Remote control-less setting

To set the unit to high ceiling setting, there is a method that requires the changing of the short plugs on the indoor P.C. board. The details are shown in the below table.

This method is only to be used where a wired remote control (Group control) is not used.

* However, once the setting is changed, it is necessary to reset the setting back to 0000 that placing the short plugs back to the factory default position and rewriting the setting data back to 0000 with wired remote control. (The setting can be changed to 0001 and 0003 without resetting.)

- Select by exchange of short plugs on indoor P.C. board.

Short plug position	SET DATA	Note
Short Open		
CN112 CN111 CN110	0000	Standard (Factory default)
CN112 CN111 CN110	0002	High ceiling (2)
CN112 CN111 CN110	0003	High ceiling (3)

- Short plugs position (CN112, CN111, CN110 from the left)

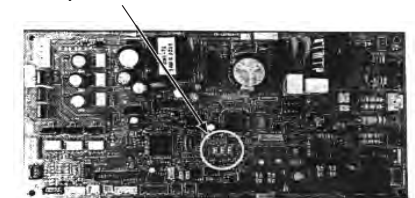

Filter sign setting

According to the installation condition, the lighting time of the filter sign (Notification of filter cleaning) can be changed.

Follow to the basic operation procedure (1 → 2 → 3 → 4 → 5 → 6).

- For the CODE No. in Procedure 3, specify [01].
- For the [Set data] in Procedure 4, select the SET DATA of filter sign lighting time from the following table.

SET DATA	Filter sign lighting time
0000	None
0001	150 H
0002	2500 H (Factory default)
0003	5000 H
0004	10000 H

To secure better effect of heating

When it is difficult to obtain satisfactory heating due to installation place of the indoor unit or structure of the room, the detection temperature of heating can be raised. Also use a circulator or other device to circulate heat air near the ceiling.

Follow to the basic operation procedure (1 → 2 → 3 → 4 → 5 → 6).

- For the CODE No. in Procedure 3, specify [06].
- For the set data in Procedure 4, select the SET DATA of shift value of detection temperature to be set up from the table below.

SET DATA	Detection temp shift value
0000	No shift
0001	+1.8 °F (+1 °C)
0002	+3.6 °F (+2 °C) (Factory default)
0003	+5.4 °F (+3 °C)
0004	+7.2 °F (+4 °C)
0005	+9.0 °F (+5 °C)
0006	+10.8 °F (+6 °C)

Remote control sensor

The temperature sensor of the indoor unit senses room temperature usually. Set the remote control sensor to sense the temperature around the remote control.

Select items following the basic operation procedure (1 → 2 → 3 → 4 → 5 → 6).

- Specify [32] for the CODE No. in Procedure 3.
- Select the following data for the SET DATA in Procedure 4.

SET DATA	0000	0001
Remote control sensor	Not used (factory setting)	Used

When  flashes, the remote control sensor is defective.

Select the SET DATA [0000] (not used) or replace the remote control.

Group control

In a group control, a remote control can control up to maximum 8 units.

- The wired remote control only can control a group control. The wireless remote control is unavailable for this control.
- For wiring procedure and wires of the individual line (Identical refrigerant line) system, refer to "Electric work" in this Manual.
- Wiring between indoor units in a group is performed in the following procedure.
- Connect the indoor units by connecting the remote control wires from the remote control terminal blocks (A, B) of the indoor unit connected with a remote control to the remote control terminal blocks (A, B) of the other indoor unit. (Non-polarity)
- For address setup, refer to the Installation Manual attached to the outdoor unit.

9 Test Run

Before test run

- Before turning on the circuit breaker, carry out the following procedure.
 - By using 500V-megger, check that resistance of 1MΩ or more exists between the terminal block L1 to L2 and the ground (grounding). If resistance of less than 1MΩ is detected, do not run the unit.
 - Check the valve of the outdoor unit being opened fully.
- To protect the compressor at activation time, leave power-ON for 12 hours or more before operating.
- Before starting a test run, be sure to set addresses following the Installation Manual supplied with the outdoor unit.

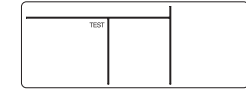

Procedure 2

Push  button.

Procedure 3

Select the operation mode with  button, [COOL] or [HEAT].

- Do not run the air conditioner in a mode other than [COOL] or [HEAT].
- The temperature controlling function does not work during test run.
- The detection of error is performed as usual.

Execute a test run

Operate the unit with the remote control as usual. For the procedure of the operation, refer to the attached Owner's Manual.

A forced test run can be executed in the following procedure even if the operation stops by thermo.-OFF. In order to prevent a serial operation, the forced test run is released after 60 minutes have passed and returns to the usual operation.

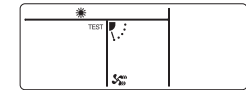

Procedure 4

After the test run, push  button to stop a test run.

(Display part is same as procedure 1.)

Procedure 5

Push  check button to cancel (release from) the test run mode.

([TEST] disappears on the display and the status returns to a normal.)

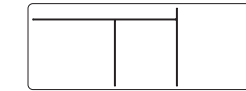

CAUTION

- Do not use the forced test run for cases other than the test run because it applies an excessive load to the devices.

Wired remote control

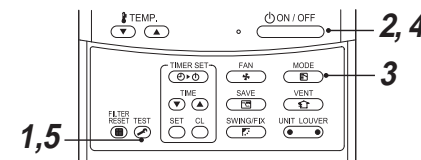

Procedure 1

Push  button for 4 seconds or more. [TEST] is displayed on the display part and the selection of mode in the test mode is permitted.



Wireless remote control**Procedure 1**

Remove a small screw which fixes the nameplate of the receiver unit.

Remove the nameplate of the sensor section by inserting a minus screwdriver, etc into the notch at the bottom of the plate, and set the Dip switch to [TEST RUN ON].

Procedure 2

Execute a test operation with  ON/OFF button on the wireless remote control.

- , , and  LED flash during test operation.
- Under status of [TEST RUN ON], the temperature adjustment from the wireless remote control is invalid.

Do not use this method in the operation other than test operation because the equipment is damaged.

Procedure 3

Use either COOL or HEAT operation mode for a test operation.

* The outdoor unit does not operate approx. 3 minutes after power-ON and operation stop.

Procedure 4

After the test operation finished, stop the air conditioner from the wireless remote control, and return Dip switch of the receiver section as before.

(A 60-minutes timer clearing function is attached to the receiver section in order to prevent a continuous test operation.)

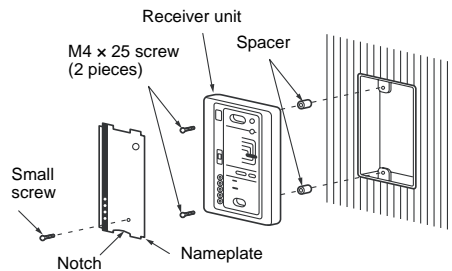

10 Troubleshooting

Confirmation and check

When an error occurred in the air conditioner, the check code and the indoor UNIT No. appear on the display part of the remote control. The check code is only displayed during the operation. If the display disappears, operate the air conditioner according to the following "Confirmation of error log" for confirmation.

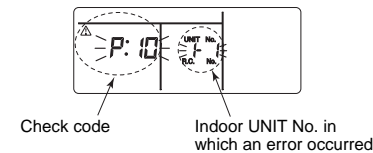

The numbers in CODE No. indicate CODE No. [01] (latest) → [04] (oldest).

REQUIREMENT

Do not push  button because all the error log of the indoor unit will be deleted.

Procedure 3



Push  button to return to the usual display after confirmation.

1. Check the errors according to the above procedure.
2. Ask an authorized dealer or qualified service (maintenance) professional to repair or maintain the air conditioner.

Confirmation of error log

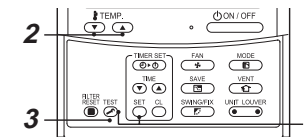
When an error occurred on the air conditioner, the error log can be confirmed with the following procedure. (The error log is stored in memory up to 4 errors.) The log can be confirmed from both operating status and stop status.

**Procedure 1**

Push  and  buttons simultaneously for 4 seconds or more, the following display appears.

If [Service check]  is displayed, the mode enters in the error log mode.

- [01: Order of error log] is displayed in CODE No. window.
- [Check code] is displayed in CHECK window.
- [Indoor unit address in which an error occurred] is displayed in Unit No.

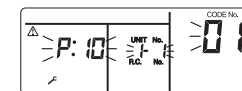
**Procedure 2**

Push  button. The error log stored in memory is displayed in order.

■ Check codes and parts to be checked

Check method

On the remote control (Wired remote control, Central control remote control) and the interface P.C. board of the outdoor unit (I/F), a check display LCD (Remote control) or 7-segment display (on the outdoor interface P.C. board) to display the operation is provided. Therefore the operation status can be known. With this self-diagnosis function, a trouble or position with error of the air conditioner can be found as shown in the table below.

Check code list

The following list shows each check code. Find the check contents from the list according to part to be checked.

- To check from indoor remote control: See "Wired remote control display" in the list.
- To check from outdoor unit: See "Outdoor 7-segment display" in the list.
- To check from indoor unit with a wireless remote control: See "Sensor block display of receiving unit" in the list.

IPDU : Intelligent Power Drive Unit
 ○ : Lighting, □ : Flashing, ● : Goes off
 ALT. : Flashing is alternately when there are two flashing LED.
 SIM : Simultaneous flashing when there are two flashing LED.

Check code		Wireless remote control				Check code name	Judging device
Wired remote control display	Outdoor 7-segment display	Sensor block display of receiving unit					
	Auxiliary code	Operation	Timer	Ready	Flash		
E01	—	—	□	●	●	Communication error between indoor and remote control (Detected at remote control side)	Remote control
E02	—	—	□	●	●	Remote control transmission error	Remote control
E03	—	—	□	●	●	Communication error between indoor and remote control (Detected at indoor side)	Indoor
E04	—	—	●	●	□	Communication circuit error between indoor/outdoor (Detected at indoor side)	Indoor
E06	E06	No. of indoor units in which sensor has been normally received	●	●	□	Decrease of No. of indoor units	I/F
—	E07	—	●	●	□	Communication circuit error between indoor/outdoor (Detected at outdoor side)	I/F
E08	E08	Duplicated indoor addresses	□	●	●	Duplicated indoor addresses	Indoor / I/F
E09	—	—	□	●	●	Duplicated header remote controls	Remote control
E10	—	—	□	●	●	Communication error between indoor MCU	Indoor
E12	E12	01: Indoor/Outdoor communication 02: Communication between outdoor units	□	●	●	Automatic address start error	I/F
E15	E15	—	●	●	□	Indoor is nothing during automatic addressing	I/F
E16	E16	00: Capacity over 01 ~No. of connected units	●	●	□	Capacity over / No. of connected indoor units	I/F
E18	—	—	□	●	●	Communication error between indoor units	Indoor
E19	E19	00: Header is nothing 02: Two or more header units	●	●	□	Outdoor header units quantity error	I/F
E20	E20	01: Outdoor of other line connected 02: Indoor of other line connected	●	●	□	Other line connected during automatic address	I/F
E23	E23	—	●	●	□	Sending error in communication between outdoor units	I/F
E25	E25	—	●	●	□	Duplicated follower outdoor addresses	I/F
E26	E26	No. of outdoor units which received signal normally	●	●	□	Decrease of No. of connected outdoor units	I/F
E28	E28	Detected outdoor unit number	●	●	□	Follower outdoor unit error	I/F

Check code		Wireless remote control				Check code name	Judging device																																																																																						
Wired remote control display	Outdoor 7-segment display	Sensor block display of receiving unit																																																																																											
	Auxiliary code	Operation	Timer	Ready	Flash																																																																																								
E31	E31	<table border="1"> <thead> <tr> <th rowspan="2"></th> <th colspan="3">A3-IPDU</th> <th rowspan="2">Fan IPDU</th> </tr> <tr> <th>1</th> <th>2</th> <th>3</th> </tr> </thead> <tbody> <tr><td>01</td><td>○</td><td></td><td></td><td></td></tr> <tr><td>02</td><td></td><td>○</td><td></td><td></td></tr> <tr><td>03</td><td>○</td><td>○</td><td></td><td></td></tr> <tr><td>04</td><td></td><td></td><td>○</td><td></td></tr> <tr><td>05</td><td>○</td><td></td><td>○</td><td></td></tr> <tr><td>06</td><td></td><td>○</td><td>○</td><td></td></tr> <tr><td>07</td><td>○</td><td>○</td><td>○</td><td></td></tr> <tr><td>08</td><td></td><td></td><td></td><td>○</td></tr> <tr><td>09</td><td>○</td><td></td><td></td><td>○</td></tr> <tr><td>0A</td><td></td><td>○</td><td></td><td>○</td></tr> <tr><td>0B</td><td>○</td><td>○</td><td></td><td>○</td></tr> <tr><td>0C</td><td></td><td></td><td>○</td><td>○</td></tr> <tr><td>0D</td><td>○</td><td></td><td>○</td><td>○</td></tr> <tr><td>0E</td><td></td><td>○</td><td>○</td><td>○</td></tr> <tr><td>0F</td><td>○</td><td>○</td><td>○</td><td>○</td></tr> </tbody> </table>					A3-IPDU			Fan IPDU	1	2	3	01	○				02		○			03	○	○			04			○		05	○		○		06		○	○		07	○	○	○		08				○	09	○			○	0A		○		○	0B	○	○		○	0C			○	○	0D	○		○	○	0E		○	○	○	0F	○	○	○	○	●	●	□	IPDU communication error	I/F
			A3-IPDU				Fan IPDU																																																																																						
			1	2	3																																																																																								
		01	○																																																																																										
		02		○																																																																																									
		03	○	○																																																																																									
		04			○																																																																																								
		05	○		○																																																																																								
		06		○	○																																																																																								
		07	○	○	○																																																																																								
		08				○																																																																																							
		09	○			○																																																																																							
		0A		○		○																																																																																							
		0B	○	○		○																																																																																							
0C			○	○																																																																																									
0D	○		○	○																																																																																									
0E		○	○	○																																																																																									
0F	○	○	○	○																																																																																									
F01	—	—	□	□	●	ALT	Indoor TCJ sensor error	Indoor																																																																																					
F02	—	—	□	□	●	ALT	Indoor TC2 sensor error	Indoor																																																																																					
F03	—	—	□	□	●	ALT	Indoor TC1 sensor error	Indoor																																																																																					
F04	F04	—	□	□	○	ALT	TD1 sensor error	I/F																																																																																					
F05	F05	—	□	□	○	ALT	TD2 sensor error	I/F																																																																																					
F06	F06	TE1 sensor TE2 sensor	□	□	○	ALT	TE1 sensor error TE2 sensor error	I/F																																																																																					
F07	F07	—	□	□	○	ALT	TL sensor error	I/F																																																																																					
F08	F08	—	□	□	○	ALT	TO sensor error	I/F																																																																																					
F10	—	—	□	□	●	ALT	Indoor TA sensor error	Indoor																																																																																					
F12	F12	—	□	□	○	ALT	TS1 sensor error	I/F																																																																																					
F13	F13	01: Comp. 1 side 02: Comp. 2 side 03: Comp. 3 side	□	□	○	ALT	TH sensor error	IPDU																																																																																					
F15	F15	—	□	□	○	ALT	Outdoor temp. sensor miswiring (TE1, TL)	I/F																																																																																					
F16	F16	—	□	□	○	ALT	Outdoor pressure sensor miswiring (Pd, Ps)	I/F																																																																																					
F22	F22	—	□	□	○	ALT	TD3 error	I/F																																																																																					
F23	F23	—	□	□	○	ALT	Ps sensor error	I/F																																																																																					
F24	F24	—	□	□	○	ALT	Pd sensor error	I/F																																																																																					
F29	—	—	□	□	●	SIM	Indoor other error	Indoor																																																																																					
F31	F31	—	□	□	○	SIM	Indoor EEPROM error	I/F																																																																																					
H01	H01	01: Comp. 1 side 02: Comp. 2 side 03: Comp. 3 side	●	□	●		Compressor break down	IPDU																																																																																					
H02	H02	01: Comp. 1 side 02: Comp. 2 side 03: Comp. 3 side	●	□	●		Compressor trouble (lock)	IPDU																																																																																					
H03	H03	01: Comp. 1 side 02: Comp. 2 side 03: Comp. 3 side	●	□	●		Current detect circuit system error	IPDU																																																																																					
H05	H05	—	●	□	●		TD1 miswiring	I/F																																																																																					
H06	H06	—	●	□	●		Low pressure protective operation	I/F																																																																																					
H07	H07	—	●	□	●		Oil level down detective protection	I/F																																																																																					
H08	H08	01: TK1 sensor error 02: TK2 sensor error 03: TK3 sensor error 04: TK4 sensor error	●	□	●		Oil level detective temp sensor error	I/F																																																																																					
H15	H15	—	●	□	●		TD2 miswiring	I/F																																																																																					

Check code		Wireless remote control				Check code name	Judging device																																																																								
Wired remote control display	Outdoor 7-segment display	Sensor block display of receiving unit																																																																													
	Auxiliary code	Operation	Timer	Ready	Flash																																																																										
H16	H16	01: TK1 oil circuit system error 02: TK2 oil circuit system error 03: TK3 oil circuit system error 04: TK4 oil circuit system error	●	○	●		Oil level detective circuit error	I/F																																																																							
H25	H25	—	●	○	●		TD3 miswiring	I/F																																																																							
L03	—	—	○	●	○	SIM	Indoor center unit duplicated	Indoor																																																																							
L04	L04	—	○	○	○	SIM	Outdoor line address duplicated	I/F																																																																							
L05	—	—	○	●	○	SIM	Duplicated indoor units with priority (Displayed in indoor unit with priority)	I/F																																																																							
L06	L06	No. of indoor units with priority	○	●	○	SIM	Duplicated indoor units with priority (Displayed in unit other than indoor unit with priority)	I/F																																																																							
L07	—	—	○	●	○	SIM	Group line in individual indoor unit	Indoor																																																																							
L08	L08	—	○	●	○	SIM	Indoor group/Address unset	Indoor, I/F																																																																							
L09	—	—	○	●	○	SIM	Indoor capacity unset	Indoor																																																																							
L10	L10	—	○	○	○	SIM	Outdoor capacity unset	I/F																																																																							
L17	L17	—	○	○	○	SIM	Outdoor unit model unmatched error	I/F																																																																							
L20	—	—	○	○	○	SIM	Duplicated central control addresses	Indoor																																																																							
L28	L28	—	○	○	○	SIM	Over No. of connected outdoor units	I/F																																																																							
L29	L29	<table border="1"> <thead> <tr> <th colspan="3">A3-IPDU</th> <th rowspan="2">Fan IPDU</th> </tr> <tr> <th>1</th> <th>2</th> <th>3</th> </tr> </thead> <tbody> <tr><td>01</td><td>○</td><td></td><td></td></tr> <tr><td>02</td><td></td><td>○</td><td></td></tr> <tr><td>03</td><td>○</td><td>○</td><td></td></tr> <tr><td>04</td><td></td><td></td><td>○</td></tr> <tr><td>05</td><td>○</td><td></td><td>○</td></tr> <tr><td>06</td><td></td><td>○</td><td>○</td></tr> <tr><td>07</td><td>○</td><td>○</td><td>○</td></tr> <tr><td>08</td><td></td><td></td><td>○</td></tr> <tr><td>09</td><td>○</td><td></td><td>○</td></tr> <tr><td>0A</td><td></td><td>○</td><td>○</td></tr> <tr><td>0B</td><td>○</td><td>○</td><td>○</td></tr> <tr><td>0C</td><td></td><td></td><td>○</td></tr> <tr><td>0D</td><td>○</td><td></td><td>○</td></tr> <tr><td>0E</td><td></td><td>○</td><td>○</td></tr> <tr><td>0F</td><td>○</td><td>○</td><td>○</td></tr> <tr><td colspan="4">○ : IPDU error</td></tr> </tbody> </table>	A3-IPDU			Fan IPDU	1	2	3	01	○			02		○		03	○	○		04			○	05	○		○	06		○	○	07	○	○	○	08			○	09	○		○	0A		○	○	0B	○	○	○	0C			○	0D	○		○	0E		○	○	0F	○	○	○	○ : IPDU error				○	●	○	SIM	No. of IPDU error	I/F
A3-IPDU			Fan IPDU																																																																												
1	2	3																																																																													
01	○																																																																														
02		○																																																																													
03	○	○																																																																													
04			○																																																																												
05	○		○																																																																												
06		○	○																																																																												
07	○	○	○																																																																												
08			○																																																																												
09	○		○																																																																												
0A		○	○																																																																												
0B	○	○	○																																																																												
0C			○																																																																												
0D	○		○																																																																												
0E		○	○																																																																												
0F	○	○	○																																																																												
○ : IPDU error																																																																															
L30	L30	Detected indoor address	○	○	○	SIM	Indoor outside interlock	Indoor																																																																							
—	L31	—	—	—	—		Extended I/C error	I/F																																																																							
P01	—	—	●	○	○	ALT	Indoor fan motor error	Indoor																																																																							
P03	P03	—	○	●	○	ALT	Discharge temp. TD1 error	I/F																																																																							
P04	P04	01: Comp. 1 side 02: Comp. 2 side 03: Comp. 3 side	○	●	○	ALT	High-pressure SW system operation	IPDU																																																																							
P05	P05	00: Detected phase loss 01: Comp. 1 side 02: Comp. 2 side 03: Comp. 3 side	○	●	○	ALT	Phase loss error/interruption of power supply Inverter DC voltage (Vdc) error	I/F																																																																							
P07	P07	01: Comp. 1 side 02: Comp. 2 side 03: Comp. 3 side	○	●	○	ALT	Heat sink overheat error	IPDU, I/F																																																																							
P10	P10	Detected indoor address	●	○	○	ALT	Indoor overflow error	Indoor																																																																							
P12	—	—	●	○	○	ALT	Indoor fan motor error	Indoor																																																																							
P13	P13	—	●	○	○	ALT	Outdoor liquid back detection error	I/F																																																																							
P15	P15	01: TS condition 02: TD condition	○	●	○	ALT	Gas leak detection	I/F																																																																							
P17	P17	—	○	●	○	ALT	Discharge temp. TD2 error	I/F																																																																							

Check code		Wireless remote control				Check code name	Judging device	
Wired remote control display	Outdoor 7-segment display	Sensor block display of receiving unit						
	Auxiliary code	Operation	Timer	Ready	Flash			
P18	P18	—	○	●	○	ALT	Discharge temp. TD3 error	I/F
P19	P19	Detected outdoor unit number	○	●	○	ALT	4-way valve inverse error	I/F
P20	P20	—	○	●	○	ALT	High-pressure protective operation	I/F
P22	P22	0*: IGBT circuit 1*: Location detection circuit error 3*: Motor lock-up error 4*: Motor current was detected. C*: Abnormal temperature was detected by the TH sensor. D*: TH sensor error E*: Inverter DC voltage error (outdoor unit fan) Caution) Although letters 0 to F appear at locations indicated by "*", please ignore them.	○	●	○	ALT	Outdoor fan IPDU error	IPDU
P26	P26	01: Comp. 1 side 02: Comp. 2 side 03: Comp. 3 side	○	●	○	ALT	G-TR short protection error	IPDU
P29	P29	01: Comp. 1 side 02: Comp. 2 side 03: Comp. 3 side	○	●	○	ALT	Comp position detective circuit system error	IPDU
P31	P31	—	○	●	○	ALT	Other indoor unit error (Group follower unit error)	Indoor

Error detected by TCC-LINK central control device

Check code		Wireless remote control				Check code name	Judging device	
Wired remote control display	Outdoor 7-segment display	Sensor block display of receiving unit						
	Auxiliary code	Operation	Timer	Ready	Flash			
C05	—	—	—	—	—	Sending error in TCC-LINK central control device	TCC-LINK	
C06	—	—	—	—	—	Receiving error in TCC-LINK central control device	TCC-LINK	
C12	—	—	—	—	—	Batch alarm of general-purpose equipment control interface	General-purpose equipment I/F	
P30	—	Differs according to error contents of unit with occurrence of alarm	(L20 is displayed)				Group control branching unit error Duplicated central control addresses	TCC-LINK

TCC-LINK : TOSHIBA Carrier Communication Link.

WARNINGS ON REFRIGERANT LEAKAGE

Check of Concentration Limit

The room in which the air conditioner is to be installed requires a design that in the event of refrigerant gas leaking out, its concentration will not exceed a set limit.

The refrigerant R410A which is used in the air conditioner is safe, without the toxicity or combustibility of ammonia, and is not restricted by laws to be imposed which protect the ozone layer. However, since it contains more than air, it poses the risk of suffocation if its concentration should rise excessively. Suffocation from leakage of R410A is almost non-existent. With the recent increase in the number of high concentration buildings, however, the installation of multi air conditioner systems is on the increase because of the need for effective use of floor space, individual control, energy conservation by curtailing heat and carrying power etc.

Most importantly, the multi air conditioner system is able to replenish a large amount of refrigerant compared with conventional individual air conditioners. If a single unit of the multi conditioner system is to be installed in a small room, select a suitable model and installation procedure so that if the refrigerant accidentally leaks out, its concentration does not reach the limit (and in the event of an emergency, measures can be made before injury can occur).

In a room where the concentration may exceed the limit, create an opening with adjacent rooms, or install mechanical ventilation combined with a gas leak detection device. The concentration is as given below.

$$\frac{\text{Total amount of refrigerant (lbs (kg))}}{\text{Min. volume of the indoor unit installed room (ft}^3 \text{ (m}^3\text{))}} \leq \text{Concentration limit (lbs/ft}^3 \text{ (kg/m}^3\text{))}$$

The concentration limit of R410A which is used in multi air conditioners is 0.019lbs/ft³ (0.3kg/m³).

NOTE 1 :
If there are 2 or more refrigerating systems in a single refrigerating device, the amounts of refrigerant should be as charged in each independent device.

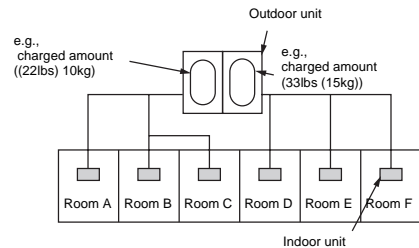

For the amount of charge in this example:
The possible amount of leaked refrigerant gas in rooms A, B and C is 22lbs (10kg).
The possible amount of leaked refrigerant gas in rooms D, E and F is 33lbs (15kg).

Important

NOTE 2 :
The standards for minimum room volume are as follows.

- (1) No partition (shaded portion)

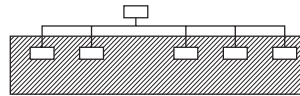

- (2) When there is an effective opening with the adjacent room for ventilation of leaking refrigerant gas (opening without a door, or an opening 0.15% or larger than the respective floor spaces at the top or bottom of the door).

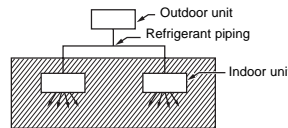

- (3) If an indoor unit is installed in each partitioned room and the refrigerant piping is interconnected, the smallest room of course becomes the object. But when a mechanical ventilation is installed interlocked with a gas leakage detector in the smallest room where the density limit is exceeded, the volume of the next smallest room becomes the object.

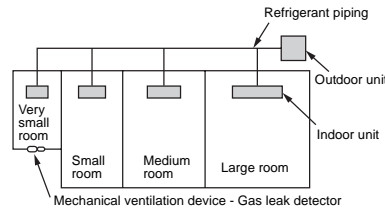

NOTE 3 :
The minimum indoor floor area compared with the amount of refrigerant is roughly as follows:
(When the ceiling is 8.9ft (2.7m) high)

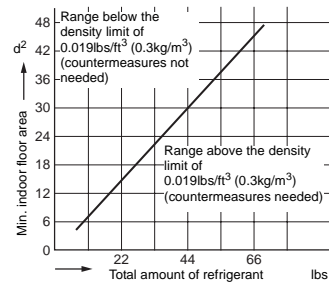

Confirmation of Indoor Unit Setup

Prior to delivery to the customer, check the address and setup of the indoor unit, which has been installed in this time and fill the check sheet (Table below).
Data of four units can be entered in this check sheet. Copy this sheet according to the No. of the indoor units. If the installed system is a group control system, use this sheet by entering each line system into each installation manual attached to the other indoor units.

REQUIREMENT

This check sheet is required for maintenance after installation. Fill this sheet and then pass this Installation Manual to the customers.

Indoor unit setup check sheet

Indoor unit			Indoor unit			Indoor unit			Indoor unit		
Room name			Room name			Room name			Room name		
Model			Model			Model			Model		
Check indoor unit address. (For check method, refer to Applicable controls in this manual.) * In case of a single system, it is unnecessary to enter the indoor address. (CODE No.: Line [12], Indoor [13], Group [14], Central control [03])											
Line	Indoor	Group	Line	Indoor	Group	Line	Indoor	Group	Line	Indoor	Group
Central control address			Central control address			Central control address			Central control address		
Various setup			Various setup			Various setup			Various setup		
Have you changed high ceiling setup? If not, fill check mark [x] in [NO CHANGE], and fill check mark [x] in [ITEM] if changed, respectively. (For check method, refer to Applicable controls in this manual.) * In case of replacement of short plugs on indoor microcomputer P.C. board, setup is automatically changed.											
High ceiling setup (CODE No. [5d]) <input type="checkbox"/> NO CHANGE <input type="checkbox"/> STANDARD [0000] <input type="checkbox"/> HIGH CEILING 2 [0002] <input type="checkbox"/> HIGH CEILING 3 [0003]			High ceiling setup (CODE No. [5d]) <input type="checkbox"/> NO CHANGE <input type="checkbox"/> STANDARD [0000] <input type="checkbox"/> HIGH CEILING 2 [0002] <input type="checkbox"/> HIGH CEILING 3 [0003]			High ceiling setup (CODE No. [5d]) <input type="checkbox"/> NO CHANGE <input type="checkbox"/> STANDARD [0000] <input type="checkbox"/> HIGH CEILING 2 [0002] <input type="checkbox"/> HIGH CEILING 3 [0003]			High ceiling setup (CODE No. [5d]) <input type="checkbox"/> NO CHANGE <input type="checkbox"/> STANDARD [0000] <input type="checkbox"/> HIGH CEILING 2 [0002] <input type="checkbox"/> HIGH CEILING 3 [0003]		
Have you changed lighting time of filter sign? If not, fill check mark [x] in [NO CHANGE], and fill check mark [x] in [ITEM] if changed, respectively. (For check method, refer to Applicable controls in this manual.)											
Filter sign lighting time (CODE No. [01]) <input type="checkbox"/> NO CHANGE <input type="checkbox"/> NONE [0000] <input type="checkbox"/> 150H [0001] <input type="checkbox"/> 2500H [0002] <input type="checkbox"/> 5000H [0003] <input type="checkbox"/> 10000H [0004]			Filter sign lighting time (CODE No. [01]) <input type="checkbox"/> NO CHANGE <input type="checkbox"/> NONE [0000] <input type="checkbox"/> 150H [0001] <input type="checkbox"/> 2500H [0002] <input type="checkbox"/> 5000H [0003] <input type="checkbox"/> 10000H [0004]			Filter sign lighting time (CODE No. [01]) <input type="checkbox"/> NO CHANGE <input type="checkbox"/> NONE [0000] <input type="checkbox"/> 150H [0001] <input type="checkbox"/> 2500H [0002] <input type="checkbox"/> 5000H [0003] <input type="checkbox"/> 10000H [0004]			Filter sign lighting time (CODE No. [01]) <input type="checkbox"/> NO CHANGE <input type="checkbox"/> NONE [0000] <input type="checkbox"/> 150H [0001] <input type="checkbox"/> 2500H [0002] <input type="checkbox"/> 5000H [0003] <input type="checkbox"/> 10000H [0004]		
Have you changed detected temp. shift value? If not, fill check mark [x] in [NO CHANGE], and fill check mark [x] in [ITEM] if changed, respectively. (For check method, refer to Applicable control in this manual.)											
Detected temp. shift value setup (CODE No. [06]) <input type="checkbox"/> NO CHANGE <input type="checkbox"/> NO SHIFT [0000] <input type="checkbox"/> +1°C 1.8°F [0001] <input type="checkbox"/> +2°C 3.6°F [0002] <input type="checkbox"/> +3°C 5.4°F [0003] <input type="checkbox"/> +4°C 7.2°F [0004] <input type="checkbox"/> +5°C 9.0°F [0005] <input type="checkbox"/> +6°C 10.8°F [0006]			Detected temp. shift value setup (CODE No. [06]) <input type="checkbox"/> NO CHANGE <input type="checkbox"/> NO SHIFT [0000] <input type="checkbox"/> +1°C 1.8°F [0001] <input type="checkbox"/> +2°C 3.6°F [0002] <input type="checkbox"/> +3°C 5.4°F [0003] <input type="checkbox"/> +4°C 7.2°F [0004] <input type="checkbox"/> +5°C 9.0°F [0005] <input type="checkbox"/> +6°C 10.8°F [0006]			Detected temp. shift value setup (CODE No. [06]) <input type="checkbox"/> NO CHANGE <input type="checkbox"/> NO SHIFT [0000] <input type="checkbox"/> +1°C 1.8°F [0001] <input type="checkbox"/> +2°C 3.6°F [0002] <input type="checkbox"/> +3°C 5.4°F [0003] <input type="checkbox"/> +4°C 7.2°F [0004] <input type="checkbox"/> +5°C 9.0°F [0005] <input type="checkbox"/> +6°C 10.8°F [0006]			Detected temp. shift value setup (CODE No. [06]) <input type="checkbox"/> NO CHANGE <input type="checkbox"/> NO SHIFT [0000] <input type="checkbox"/> +1°C 1.8°F [0001] <input type="checkbox"/> +2°C 3.6°F [0002] <input type="checkbox"/> +3°C 5.4°F [0003] <input type="checkbox"/> +4°C 7.2°F [0004] <input type="checkbox"/> +5°C 9.0°F [0005] <input type="checkbox"/> +6°C 10.8°F [0006]		
Incorporation of parts sold separately			Incorporation of parts sold separately			Incorporation of parts sold separately			Incorporation of parts sold separately		
Have you incorporated the following parts sold separately? If incorporated, fill check mark [x] in each [ITEM]. (When incorporating, the setup change is necessary in some cases. For setup change method, refer to Installation Manual attached to each part sold separately.)											
Panel <input type="checkbox"/> Standard panel <input type="checkbox"/> Others () <input type="checkbox"/> Others ()			Panel <input type="checkbox"/> Standard panel <input type="checkbox"/> Others () <input type="checkbox"/> Others ()			Panel <input type="checkbox"/> Standard panel <input type="checkbox"/> Others () <input type="checkbox"/> Others ()			Panel <input type="checkbox"/> Standard panel <input type="checkbox"/> Others () <input type="checkbox"/> Others ()		