

Champion[®]

Installation Manual



DH6000T-VHR

M2 SERIES

Models:

DH6000T-VHR

DH6000T

Tall hot water sanitizing machine w/fresh water rinse and built-in stainless steel electric booster, Optional Ventless Heat Recovery

DH6000-VHR

DH6000

Standard height hot water sanitizing machine w/ fresh water rinse and built-in stainless steel electric booster, optional Ventless Heat Recovery



Issue Date: 11.20.23

Manual P/N 117471 rev. E

For machines beginning with S/N D22042134 and above

NATIONAL SERVICE DEPARTMENT

USA

Toll-free: 1-800-858-4477

Tel: (336) 661-1556

Fax: (336) 661-1660

Email: service@championindustries.com

Canada

Toll-free: 1-800-263-5798

Tel: (905) 562-4195

Fax: (905) 562-4618

Email: service@moyerdiebellimited.com

ATTENTION

The machine data plate
is located at the right front corner
of the front panel.



CAUTION:

**ONLY A NON-CHLORINATED COMMERCIAL DISHWASHING
CHEMICAL SHALL BE USED IN THIS DISH WASHER.**

Three ways to **REGISTER YOUR PRODUCT and ACTIVATE YOUR WARRANTY.**

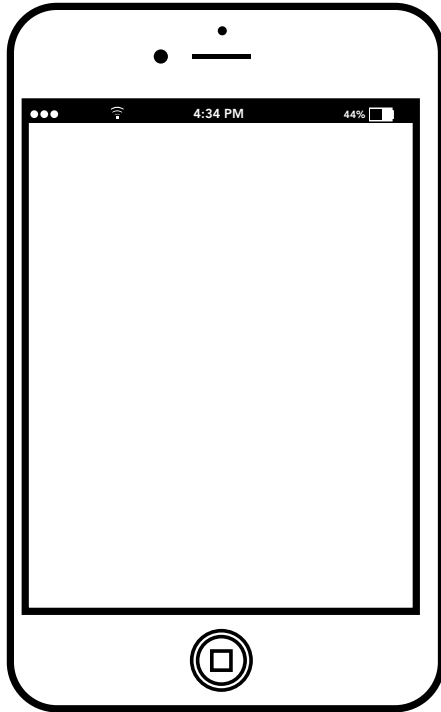

- Use your mobile device and connect to the website www.championindustries.com to register your product
- or
- Scan the QR code <http://champdw.us/DHM2> located on the lower front panel of the machine.
- or
- Complete the fax form on the next page and fax to 1(800) 661-1660.

PRODUCT REGISTRATION BY FAX

COMPLETE THIS FORM AND FAX TO:

(336) 661-1660 in the USA

1-(800) 204-0109 in Canada

PRODUCT REGISTRATION CARD

Model

Serial #

Date of Installation: ___/___/___

Company Name: _____

Address: _____
(Street) State/Province Zip/Postal Code

Telephone #: () _____ --- _____

Contact: _____

Installation Company: _____

Address: _____

Telephone #: _____

Contact: _____

FAILURE TO REGISTER YOUR PRODUCT MAY VOID YOUR WARRANTY

IMPORTANT IMPORTANT

Revision History

Due to an ongoing value analysis program at Champion Industries, specifications contained in this manual are subject to change without notice.

<i>Revision Date</i>	<i>Revised Pages</i>	<i>Serial Number Effectivity</i>	<i>Revision Description</i>
4.30.22	All	D22042134	Released first edition
6.9.22	Registration	D22042134	Added QR code label
3.1.23	All	D230322622	Revised chemical system data
5.25.23	5	All	Removed VHR from Hot Water Connection
7.5.23	7	D230623061	Deleted Mechanical DWT and replaced with Electric DWT
11.20.23	40-41	All	Revised P/N 901242 to correct P/N 901168 .

Limited Warranty

LIMITED WARRANTY

Champion Industries (herein referred to as "The Company"), 3765 Champion Blvd., Winston-Salem, North Carolina 27105, and 2674 N. Service Road, Jordan Station, Ontario, Canada, L0R 1S0, warrants machines, and parts, as set out below.

Warranty of Machines: The Company warrants all new machines of its manufacture bearing the name "Champion and installed within the United States and Canada to be free from defects in material and workmanship for a period of one (1) year after the date of installation or fifteen (15) months after the date of shipment by The Company, whichever occurs first. [See below for special provisions relating to glasswashers.] Warranty registration must be submitted to The Company within ten (10) days after installation either online on the Champion Industries website (<http://www.championindustries.com>) or by the fax form provided at the front of this manual. The Company will not assume any responsibility for extra costs for installation in any area where there are jurisdictional problems with local trades or unions.

If a defect in workmanship or material is found to exist within the warranty period, The Company, at its election, will either repair or replace the defective part or accept return of the machine for full credit; provided; however, as to glasswashers, The Company's obligation with respect to labor associated with any repairs shall end (a) 120 days after shipment, or (b) 90 days after installation, whichever occurs first. In the event that The Company elects to repair, the labor and work to be performed in connection with the warranty shall be done during regular working hours by a Champion authorized service technician. Defective parts become the property of The Company. Use of replacement parts not authorized by The Company will relieve The Company of all further liability in connection with its warranty. In no event will The Company's warranty obligation exceed The Company's charge for the machine. The following are not covered by The Company's warranty:

- a. Lighting of gas pilots or burners.
- b. Cleaning of gas lines.
- c. Replacement of fuses or resetting of overload breakers.
- d. Adjustment of thermostats.
- e. Adjustment of clutches.
- f. Opening or closing of utility supply valves or switching of electrical supply current.
- g. Cleaning of valves, strainers, screens, nozzles, or spray pipes.
- h. Performance of regular maintenance and cleaning as outlined in the operator's guide.
- i. Damages resulting from water conditions, accidents, alterations, improper use, abuse, tampering, improper installation, or failure to follow maintenance and operation procedures.
- j. Wear on Pulper cutter blocks, pulse vanes, and auger brush.

Examples of the defects not covered by warranty include, but are not limited to: (1) Damage to the exterior or interior finish as a result of the above, (2) Use with utility service other than that designated on the rating plate, (3) Improper connection to utility service, (4) Inadequate or excessive water pressure, (5) Corrosion from chemicals dispensed in excess of recommended concentrations, (6) Failure of electrical components due to connection of chemical dispensing equipment installed by others, (7) Leaks or damage resulting from such leaks caused by the installer, including those at machine table connections or by connection of chemical dispensing equipment installed by others, (8) Failure to comply with local building codes, (9) Damage caused by labor dispute.

Warranty of Parts: The Company warrants all new machine parts produced or authorized by The Company to be free from defects in material and workmanship for a period of 90 days from date of invoice. If any defect in material and workmanship is found to exist within the warranty period The Company will replace the defective part without charge.

DISCLAIMER OF WARRANTIES AND LIMITATIONS OF LIABILITY. THE COMPANY'S WARRANTY IS ONLY TO THE EXTENT REFLECTED ABOVE. THE COMPANY'S MAKE NO OTHER WARRANTIES, EXPRESS OR IMPLIED, INCLUDING, BUT NOT LIMITED, TO ANY WARRANTY OF MERCHANTABILITY, OR FITNESS OF PURPOSE. THE COMPANY SHALL NOT BE LIABLE FOR INCIDENTAL OR CONSEQUENTIAL DAMAGES. THE REMEDIES SET OUT ABOVE ARE THE EXCLUSIVE REMEDIES FOR ANY DEFECTS FOUND TO EXIST IN THE COMPANY'S' DISHWASHING MACHINES AND THE COMPANY'S PARTS, AND ALL OTHER REMEDIES ARE EXCLUDED, INCLUDING ANY LIABILITY FOR INCIDENTALS OR CONSEQUENTIAL DAMAGES.

The Company does not authorize any other person, including persons who deal in Champion dishwashing machines to change this warranty or create any other obligation in connection with Champion dishwashing machines.

Table of Contents

Revision History.....	i
Limited Warranty	ii
Installation Codes and Safety Symbols.....	iv

Installation	1
Receiving and Placement.....	1
Dish Table Connections.....	2
Corner Operation - Corner Splash Shield	3
Corner Operation - Track Conversion	4
VHR Cold Water Connection - DH6000-VHR, DH6000T-VHR	5
Hot Water Connection - Standard and VHR DH6000, DH6000T	5
Drain Connection.....	6
Optional Electrical Drain Water Tempering Kit Valve	7
Electrical Connections - Single and Three Phase	8
Single and Two Point Power Connection Conversion	9
Convert DH6000 208-240VAC Only from 3PH to 1PH Operation	10
Detergent Dispensing System by others	11
Detergent Signal for Dispensing Signal by others.....	11
Rinse aid Signal for Dispensing System by others.....	12
Vent Fan Control Supplied by others.....	13
Optional Champion Chemical Dispensers.....	14
Supervisor Menus	15
Enter Supervisor Menu	15
Enter Chemical Setup Menu.....	15
Detergent Sensors.....	16
Detergent Prime and Rinse Aid Prime Buttons.....	16
Set Rinse Aid Set point.....	16
Set Detergent Cycle Times	16
Inline Sensor (Only) - Normal Operation	17
Inline Sensor (Only) - Operation Error	17
Inline Sensor (Only) - Factory Default Dosage Chart	17
If equipped, Tank Sensor (Only) - Normal Operation.....	18
If equipped, Tank Sensor (Only) - Operation Error	18
If equipped, Tank Sensor (Only) - Factory Default Dosage Chart.....	18
Inline and Tank Sensor, (if equipped) - Normal Operation.....	19
Inline and Tank Sensor, (if equipped) - Operation Error	19

Table of Contents (continued)

Supervisor Menus (continued)

Inline and Tank Sensor, (if equipped) - Factory Default Dosage Chart	19
Inline and Tank Sensor, (if equipped) - Setting Concentration	20
Sleep	21
Fill Time Exceeded	22
On for Celsius.....	22
Water Refresh	22
Navigation Buttons	22
I/O - Inputs Outputs	23
Active Faults.....	23
Cycle Count.....	24
Manuals.....	24
Revision.....	25
Start Delime.....	26
Factory Setup	25
MAINT	26
Temp Set points.....	27
Function Test.....	27
High Booster.....	27
Fault Counters.....	28
Temp Offset	28
Drain Water Tempering (DWT).....	28
Temp Lockout.....	28
Door Lock	28
Detergent.....	28
Detergent Lockout.....	28
Delime Setup.....	29
Delime Notification Setup	30
Start Delime.....	30
Delime Operation	31
Start Delime.....	30
Fault Messages	34
Fill Time Exceeded	34
Drain Time Exceeded	34
Float Fault	35
Temperature Sensor Fault.....	35
APPENDIX A: Installing DH6000T Corner Shield Kit, P/N 901114	36
APPENDIX B: Kit P/N 901242, DH6000/T 1 to 2-point Terminal Block Conversion.....	40
APPENDIX C: Electric Drain Valve Manual Operation	42

**This Page
Intentionally
Left Blank**

INSTALLATION

Installation Codes

The installation of the dishwasher must comply with all local electrical, plumbing, health and safety codes or in the absence of local codes, installed in accordance with the applicable requirements in the National Electrical Code, NFPA 70, Canadian Electrical Code (CEC), Part 1, CSA C22.1; and the Standard for Ventilation Control and Fire Protection of Commercial Cooking Operations, NFPA 96.



CAUTION:

Damage or problems associated with improper installation will not be covered by the limited warranty.

Safety Symbols

The following symbols are used throughout this manual to alert the reader to important information.



WARNING:

Warning statements indicate a condition or practice that can result in personal injury or possible death.



CAUTION:

Caution statements indicate a condition or practice that can result in damage to the machine or associated equipment.



NOTE:

Note statements highlight important information necessary for the operation of the machine.

Receiving



Inspect the outside of the shipping carton for signs of damage and report any damage immediately to a supervisor.

Remove the carton, inspect the dishwasher, and check the inside of the machine for accessories and installation parts.

Register your machine by fax or online as soon as possible.



CAUTION:

Be careful when lifting and moving the machine to avoid damage.

Placement

Compare the installation site utility connections with the dishwasher utility connections to ensure they are the same.

Provide 20" [508 mm] on right, left, and front sides of the machine and 27" [686 mm] above the finished floor.

The dishwasher has four adjustable feet for leveling. Level the dishwasher front-to-back and side-to-side.



NOTE:

Dishwashers are shipped from the factory for straight-through operation but are field convertible to corner operation.

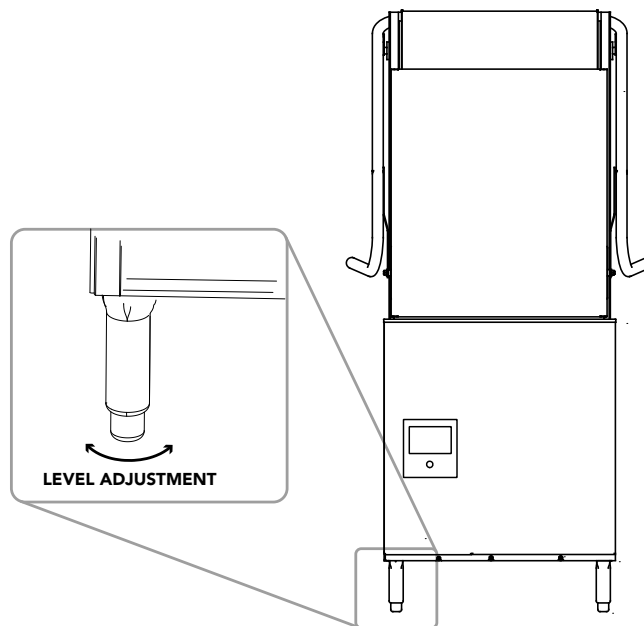

Fig. 1 - Adjustable feet

Dish Table Connections



CAUTION:

Do not attach the dish tables until the dishwasher is set in its permanent location.

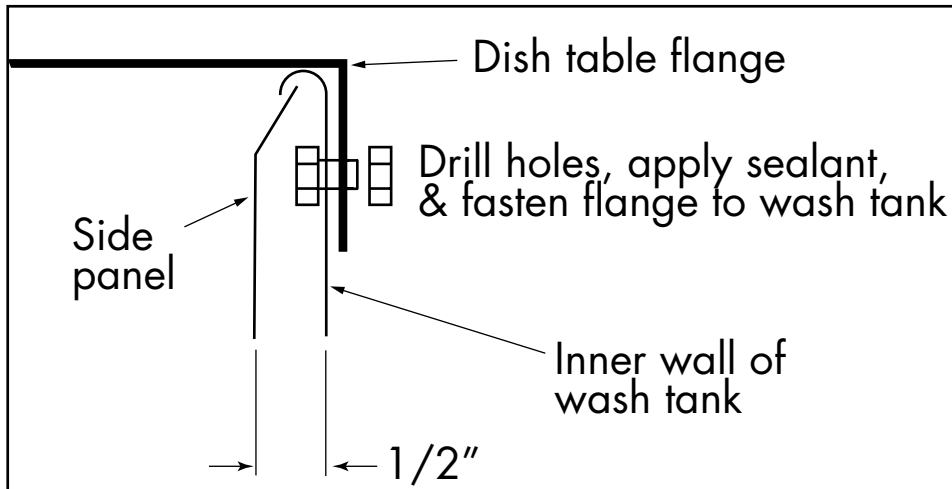

Fig. 2 - Dish table installation (if required)

Level the dishwasher and dish tables to the required height. Fit the dish table flanges over the ends of the dishwasher tank and mark two hole locations. Drill 1/4" holes through the table flange and the dishwasher tank. Apply sealant between the table flanges and the wash tank. Install stainless steel 1/4-20 fasteners to secure.

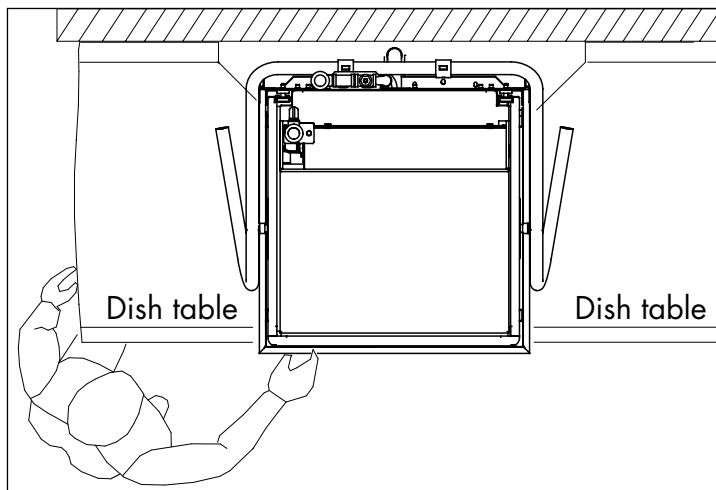

Fig. 3 - Nominal dish table configuration

Corner Operation - Corner Splash Shield

Machines are shipped from the factory for straight through operation. To convert for corner operation:

1. The control panel must be accessible from the front as shown in Fig. 4.
2. Install the optional splash shield, if included with machine, see Fig. 5. Detailed instructions can be found in Appendix A, page 36, for "Corner Splash Shield Installation Instructions".

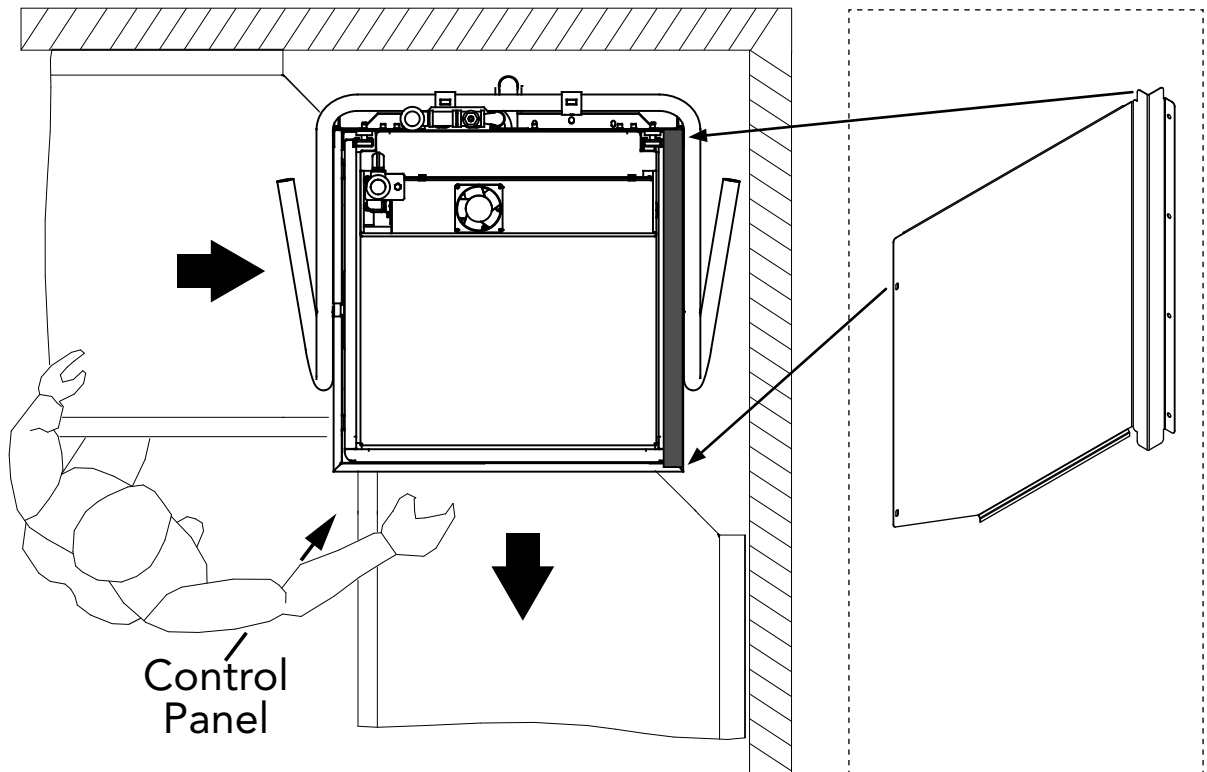

Fig. 4 - Nominal corner installation

Fig. 5 - Corner splash shield



NOTE:

TRACK CONVERSION INSTRUCTIONS ARE ON THE NEXT PAGE.

Corner Operation - Track Conversion

Follow the steps below to convert the track assembly for corner operation:

1. Pull the track assembly straight up out of the machine.
2. Rotate the track 180° and reinstall.
3. Remove the guide attached to the track assembly, save the hardware.
4. Reposition the guide on the right-hand side of the track assembly and secure with the existing fasteners.
5. Slide a dish rack through the machine to ensure it moves freely.
6. Conversion is complete.

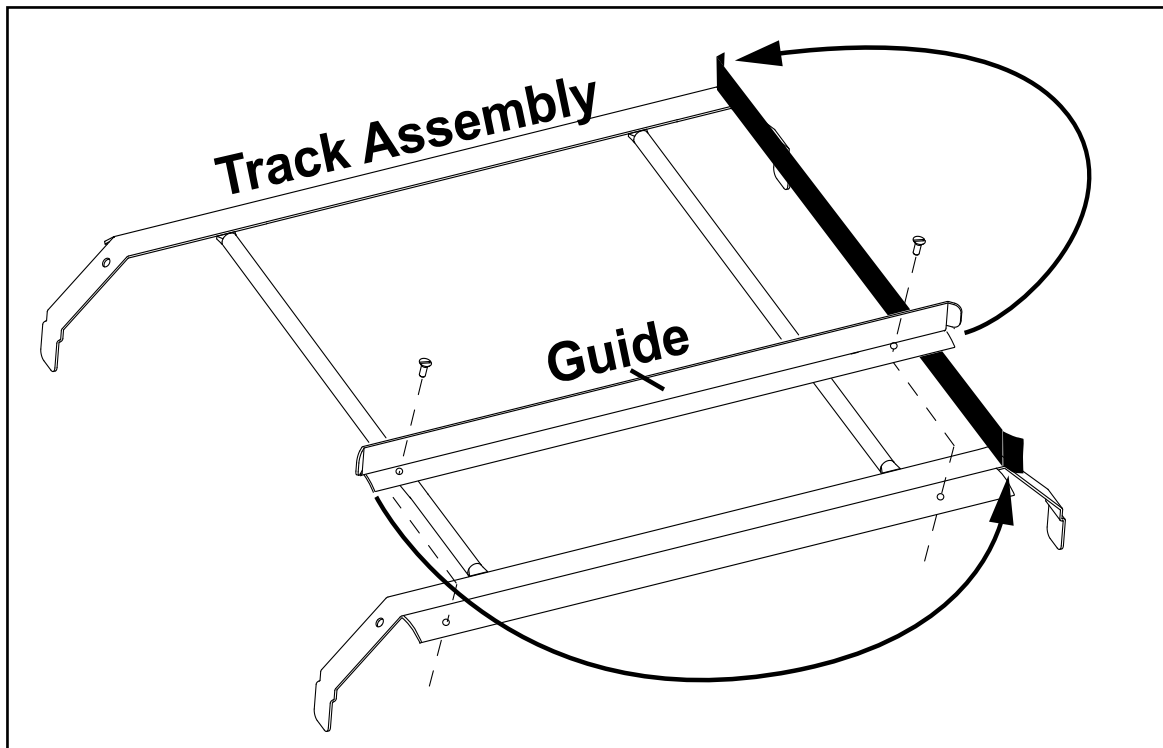

Fig. 6 - Corner track conversion

VHR Cold Water Connection

DH6000-VHR, DH6000T-VHR



**COLD
WATER**

MINIMUM 3/4" NPT COLD WATER SUPPLY

Minimum/Maximum Incoming
Temperature

55-75°/13-24°C

Minimum Incoming Supply
Flowing Pressure

46-50 PSI

Hot Water Connection- DH6000, DH6000T Standard



**HOT
WATER**

MINIMUM 3/4" NPT HOT WATER SUPPLY

Minimum/Maximum Incoming
Temperature

110-140°/43-60°C

Minimum Incoming Supply
Flowing Pressure

45 PSI/310kPa



CAUTION: To prevent damage to the dishwasher supply valves, the installing plumber must thoroughly flush debris from the water supply line before connecting it to the dishwasher. Damage caused by improper installation is not covered by the limited warranty.

- **Water hardness of 3 Grains/US Gal. - 0.83 Imp. Gal - 5.3 mg/L or less.**
- **Install a 3/4" NPT or larger full port shut-off valve in the water supply line as close to the dishwasher as a possible for servicing.**

Drain Connection



DRAIN

Gravity Drain 1" NPT Connections



CAUTION: The dishwasher drain connection must comply with all local plumbing, health and safety codes. Damage caused by improper installation is not covered by the limited warranty

Automatic Electric Drain Valve
Maximum Flow Rate: 15.0 US GPM/14.0 IPM. GPM/57LPM



Fig. 7 - 1" NPT electric drain valve connection



CAUTION:
Use caution when making drain valve plumbing connections.



NOTE:
For manual operation of the drain valve, see Appendix C, page 42, for manual operation.

Optional Electric Drain Water Tempering, (DWT)

Electric Solenoid DWT Water Valve



**COLD
WATER**

Requires a minimum 1/2" NPT DEDICATED cold water supply line.



CAUTION:

The cold water supply line must be a **dedicated** supply connection.
Do not connect the drain water tempering valve to a branch supply line.

Minimum/Maximum Incoming
Temperature

55-75°/13-24°C

Minimum Incoming Supply
Flowing Pressure

46-50 PSI

- **Water hardness of 3 Grains/US Gal. - 0.83 Imp. Gal - 5.3 mg/L or less.**

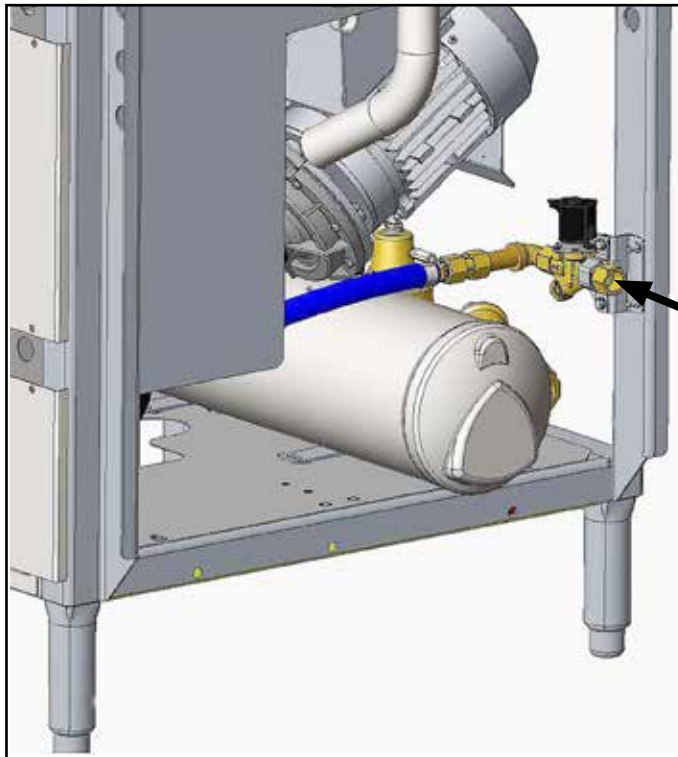

**1/2" NPT
DEDICATED
COLD WATER
SUPPLY**

Fig. 8 - Electric Drain Water Tempering Valve

Electrical Connection - Single and Three Phase



WARNING:

Turn main power off at the dishwasher and disconnect main circuit breaker before performing work on the circuit. There may be more than one power source connected to the machine.

1. Remove the right and front lower panels.
2. Route conduit to the mounting bracket located at the right rear corner of the machine (see Fig. 9). Be sure to leave a 6 foot/2 meter service loop to the machine.
3. Remove the right and front panel to access the main terminal blocks.
4. Follow the Machine Electrical Connection Data Plates for the terminal block connections.
The data plates are attached close to the blocks (Fig. 11).

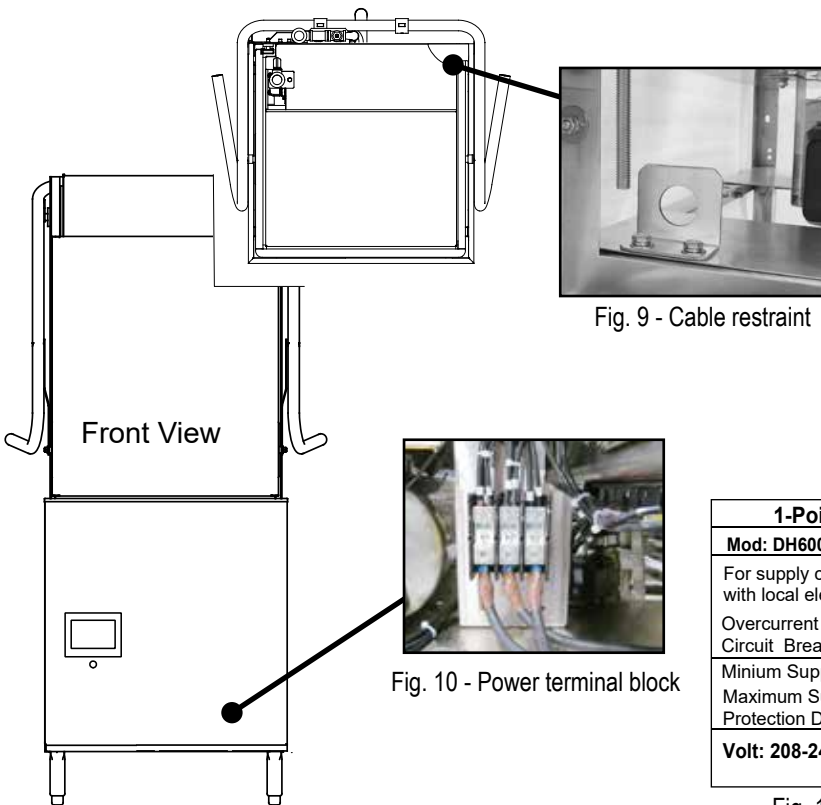

1-Point Machine Connection Data Plate			
Mod: DH6000T		Series: M2-STD	
For supply connection, use copper connectors in accordance with local electrical code. Rated Minimum 90°C (194°F).			
Overcurrent Protection Device: Time Delay or Inverse Time Circuit Breaker			
Minimum Supply Conductor Ampacity	50/50	AMPS	
Maximum Supply Overcurrent Protection Device	50/50	AMPS	
Volt: 208-240	Ph: 3	Hz: 60	Amp: 38-34

Fig. 11 - Example of connection data plate

Single to Two-Point Power Connection Conversion

1. Machine wiring can be converted from a single to a two point input power connection by installing a field conversion kit, P/N 901168.
2. New electrical connection data plates must be applied in front of the input terminal blocks.
3. Refer to end of this manual for conversion instructions.

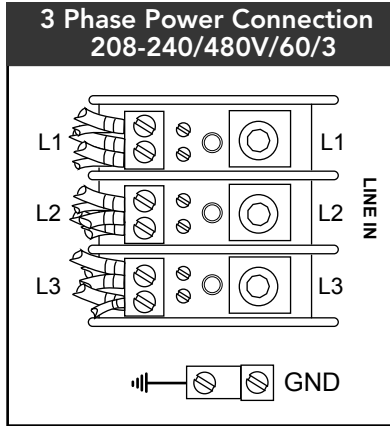

Fig. 12 - 3PH terminal block

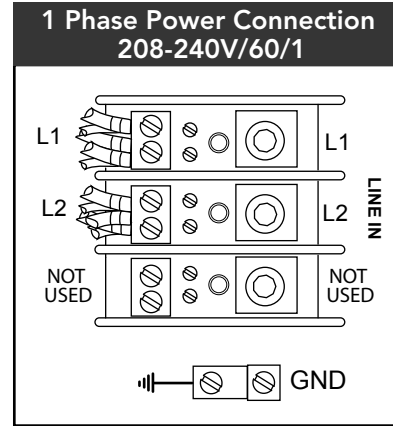
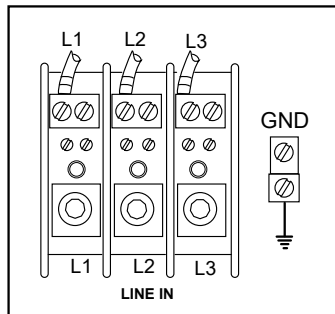
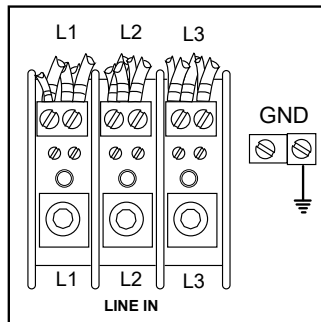

Fig. 13 - 1PH terminal block



2-Point Machine Connection Data Plate			
Mod: DH6000T	Series: M2-STD		
For supply connection, use copper connectors in accordance with local electrical code. Rated Minimum 90°C (194°F).			
Overcurrent Protection Device: Time Delay or Inverse Time Circuit Breaker			
Minimum Supply Conductor Ampacity	50/50	AMPS	
Maximum Supply Overcurrent Protection Device	50/50	AMPS	
Volt: 208-240	Ph: 3	Hz: 60	Amp: 38-34

2-Point Booster Connection Data Plate			
Mod: DH6000T	Series: M2-STD		
For supply connection, use copper connectors in accordance with local electrical code. Rated Minimum 90°C (194°F).			
Overcurrent Protection Device: Time Delay or Inverse Time Circuit Breaker			
Minimum Supply Conductor Ampacity	50/50	AMPS	
Maximum Supply Overcurrent Protection Device	50/50	AMPS	
Volt: 208-240	Ph: 3	Hz: 60	Amp: 39-34

Fig. 14 - Example of 2-point data plates



Convert DH6000 208-240VAC Only From 3PH to 1PH Operation



NOTE:
The installer must contact the factory to receive the jumper wire, jumper bars, and replacement data plate before making the conversion.

Install Jumper Wire

1. Disconnect all power to the machine.
2. Remove front panel to access the power terminal block.
3. Connect jumper wire (supplied by factory), Fig. 15, between L2 and L3 on output side of terminal block.
4. Connect power on L1 and L2 of the terminal block.

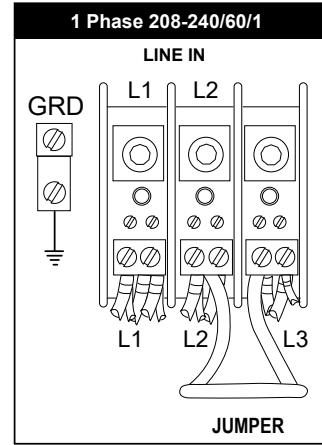

Fig. 15 - Jumper wire

Rewire Wash Tank Heater Element for 1PH

1. Rewire tank heater wires according to Fig. 16.

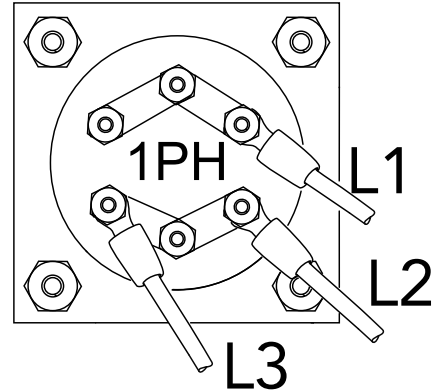

Fig. 16 - 1PH tank element connections

Rewire Booster Tank Heater Element for 1PH

1. Remove the booster heater element cover.
2. Remove the paper insulator and jumper bars from the heater terminals.
3. Install the jumper bars for 1PH as shown, Fig. 17.
4. Additional short jumper bars are stowed with the new data plate.
5. Connect the wires to the terminals as shown.
6. Reinstall the paper insulator and the booster heater element cover.

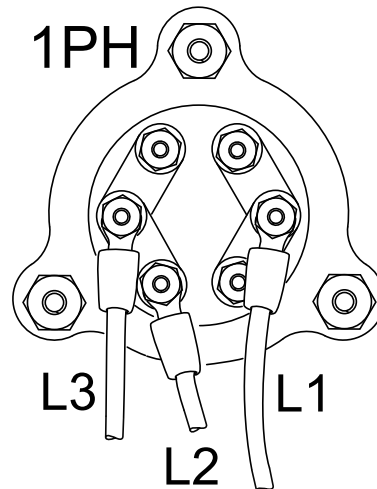

Fig. 17 - 1PH booster element connections

Detergent Dispensing System by others:

DET Detergent

- WASH TANK CAPACITY: 10 US GAL/8.3 IMP. GAL/38 L
- TWO 7/8" DIAMETER HOLES ON RIGHT-SIDE OF TANK
- TOP HOLE IS DETERGENT INJECTION
- BOTTOM HOLE IS TANK SENSOR

 **CAUTION:** Warewashing chemicals are supplied by others. Always follow supplier's instructions for proper handling and use.



Fig. 18 - Injection and tank sensor (if equipped).

 **CAUTION:** ONLY A NON-CHLORINATED COMMERCIAL DISHWASHING CHEMICAL SHALL BE USED IN THIS DISH WASHER.

Detergent Signal for Dispensing System by others.

- 120VAC FUSE BLOCK
- 2.0 AMP MAX LOAD DETERGENT SIGNAL CONNECTION.
- LOCATED ON LEFT SIDE OF COMPONENT PANEL
- SIGNAL ENABLED DURING WASH CYCLE.

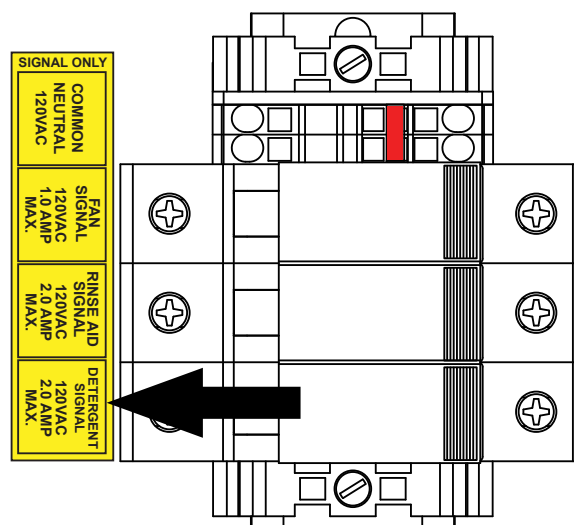

Fig. 19 - Detergent signal connection

Rinse aid Signal for Dispensing System by others.

R/A Rinse-aid



Fig. 20 - Rinse aid injection point



CAUTION:

Warewashing chemicals are supplied by others. Always follow supplier's instructions for proper handling and use.

- 120VAC FUSE BLOCK
- 2.0 AMP MAX LOAD RINSE AID SIGNAL CONNECTION.
- LOCATED ON LEFT SIDE OF COMPONENT PANEL
- SIGNAL ENABLED DURING RINSE CYCLE.

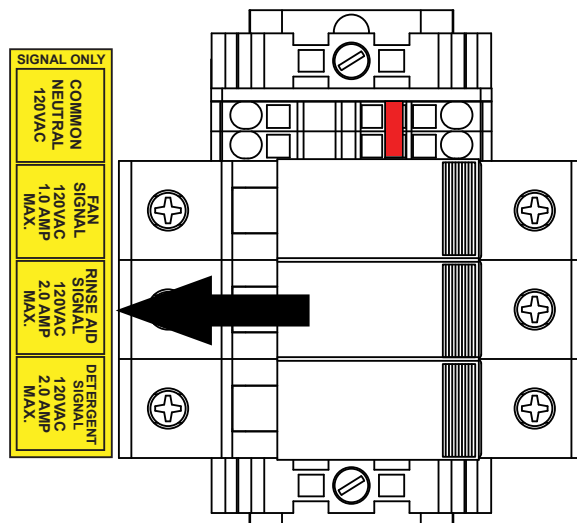

Fig. 21- Rinse aid signal connection

Vent Fan Control Supplied by others.



Ventilation (Vent Fan Control)

The standard DH6000 and DH6000T are equipped with a fused signal connection for an external vent fan contactor (supplied by others).



STOP:

The 120VAC signal is limited to a 1.0 AMP maximum load.

DO NOT CONNECT A VENT FAN MOTOR TO THE SIGNAL TERMINALS.



NOTE:

The 120VAC signal is available whenever the dishwasher green power switch is ON.

To connect the external vent fan contactor:

1. Disconnect all power to the machine.
2. Remove the lower front panel and locate the three fuse blocks on the machine base.
3. Connect one wire of the external vent fan contactor to the FAN SIGNAL fuse block.
4. Connect the other wire to a COMMON NEUTRAL terminal.
5. Connect the external vent fan contactor coil wires.
6. Re-install the lower panels.
7. Restore power to the machine.

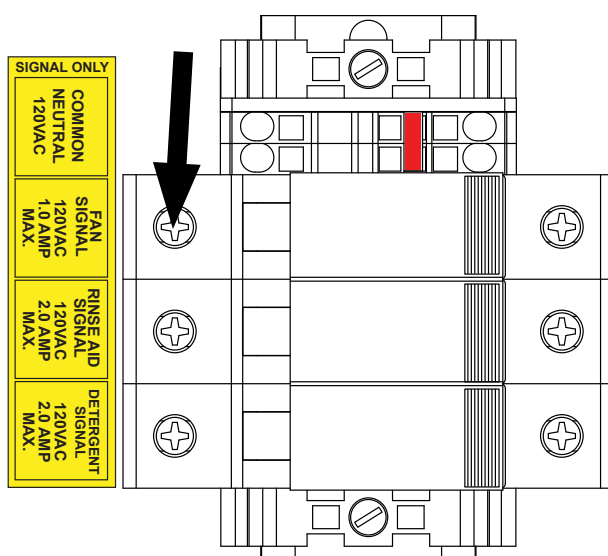

Fig. 22- Vent fan signal connection

Optional Champion Chemical Dispensers

DET Detergent

R/A Rinse-aid

1. The detergent and rinse-aid dispensers are located on the lower left side of the machine, (Fig.23).
2. Chemicals are supplied by others. Follow the chemical manufacturer's instructions for the handling and use of the chemicals.
3. If kit was specified with wash tank sensor, refer to Detergent Concentration Graphs below to set the Champion chemical dispensers on page 20.

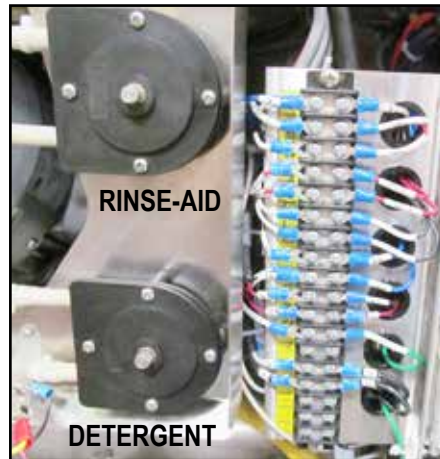
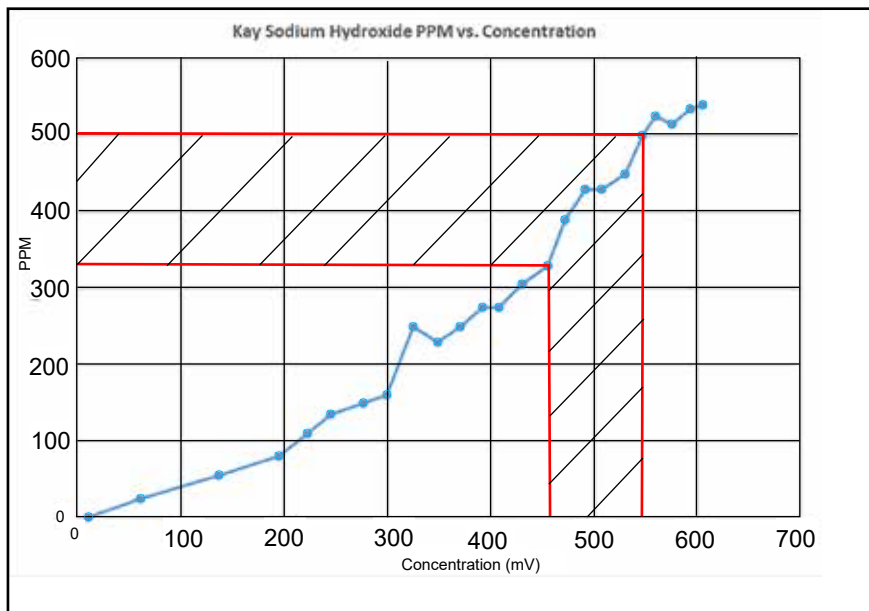
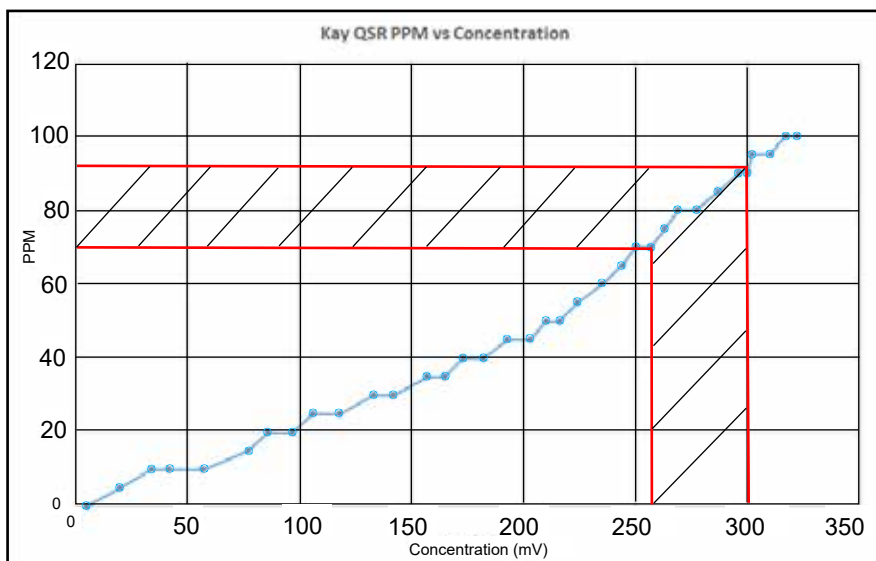

Fig. 23 - Champion dispenser pumps



- Graph 1
UltraKlene (Sodium Hydroxide 10–30%)
Based on manufacturer's recommended concentration

NOTE:
These graphs are provided only as reference. Results may change due to incoming water variations.



- Graph 2
QSR Yellow (Potassium Carbonate 5–10%)

Based on manufacturer's recommended concentration

Optional Champion Chemical Dispenser Set-up (continued)

Instructions for the Supervisor and Chemical Supplier

DISHWASHER START-UP:

1. Check chemical containers are full; pick-up tubes installed.
2. Turn water supply on.
3. Energize machine.
4. Push green start button, (Fig. 24).
5. Operation screen appears, (Fig. 25).

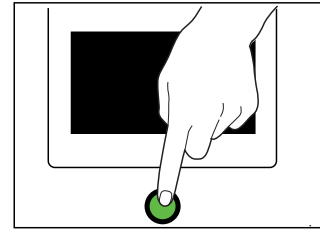

Fig. 24 - Dishwasher power switch

SUPERVISOR MENUS

ENTER SUPERVISOR MENU:

1. Chemical set-up is performed using the supervisor menu. To enter the supervisor menu:
2. Press the SETTINGS button, "gears", (Fig. 25).
3. The Supervisor Menu appears, (Fig. 26).

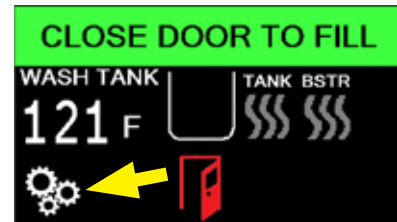

Fig. 25 - Settings button



Fig. 26 - Supervisor Menu

Navigation Buttons:



- SETTINGS: Press for Supervisor Menu



- Back-up to previous screen.



- Return to main screen.

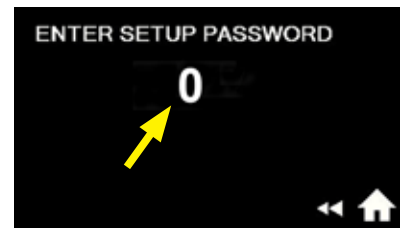

Fig. 27 - Enter password



Fig. 28 - Keypad

ENTER CHEMICAL SETUP MENU:

1. Press 'SETUP OPTIONS' button, (Fig. 26).
2. Password screen appears, (Fig. 27).
3. Press 7777, then 'ENT' on keypad, (Fig. 28).
4. Press 'CHEMICAL SETUP' button, (Fig. 29).



Fig. 29 - Set-up options menu

(continued on next page)

Optional Champion Chemical Dispenser Set-up (continued)

Instructions for the Supervisor and Chemical Supplier

Chemical Setup Menu: (continued)



Sensor Options:

Chemical dispensing controlled according to option IN-LINE only, TANK only, or both IN-LINE and TANK.

DETERGENT SENSORS:

1. If equipped:
Press 'IN-LINE' button to ON (Fig. 30).
2. If equipped:
Press 'TANK' button to ON (Fig. 30).
3. One, both, or neither, can be activated, depending on application, required use/needs, or equipped sensor configuration of the machine.

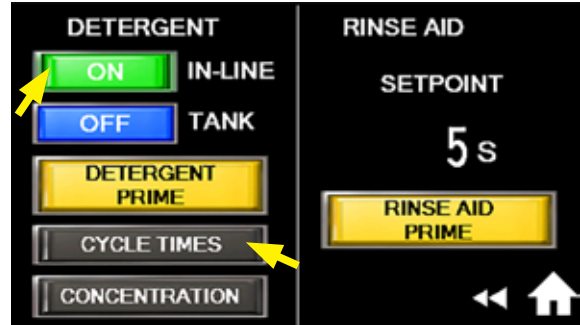

Fig. 30 - In-line sensor selected.

DETERGENT PRIME and RINSE AID PRIME BUTTONS:

1. Manually runs the chemical pumps.
2. To prime: insert pick-up hose(s) in chemical containers.
3. Press and hold either PRIME buttons.
4. Release button to stop.



Fig. 31 - If equipped, in-line sensor

SET RINSE AID SET POINT (factory default = 5 secs.):

1. Rinse aid pump runs for a set time in seconds during the final rinse.
2. To change: press "5". Keypad appears, (pg. 15, Fig. 28).
3. Press CLR, enter new value, and press ENT.
4. Confirm dose matches chemical mfg. requirements.



Fig. 32 - If equipped, tank sensor

SET DETERGENT CYCLE TIMES, (Fig. 33A):

1. Press "CYCLE TIMES".
To change: press number on the screen.
2. Keypad appears, (see Fig. 28).
3. Select new value on keypad, then ENT.
4. Repeat for each value needing change per chemical mfg. requirements derived from tank titration testing.

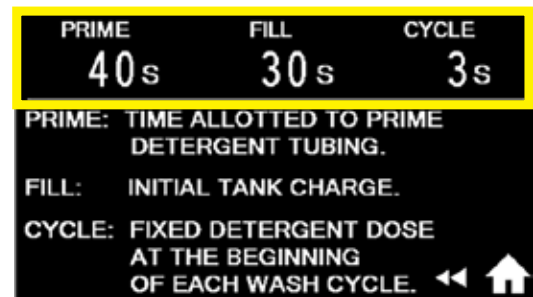

Fig. 33A - Example: Dosage cycle times

(continued on next page)

Optional Champion Chemical Dispenser Set-up (continued)

Instructions for the Supervisor and Chemical Supplier

IN-LINE Sensor (ONLY) Normal Operation (Fig. 33B):

1. Detergent pump output = 3ml/sec.
2. PRIME: Detergent pump will run for set time or until the in-line sensor detects chemical.
3. FILL: When the lower float is satisfied, detergent pump runs for set time for initial charge of detergent.
4. CYCLE: The detergent pump runs for a set time to maintain levels at the beginning of each wash cycle.

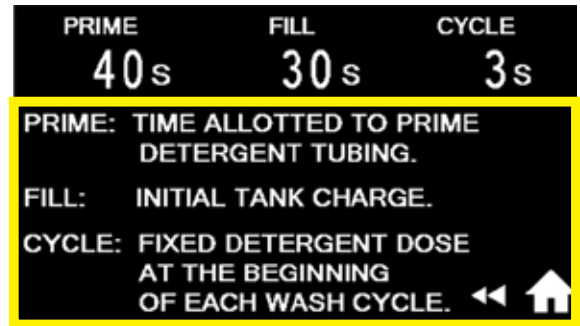

Fig. 33B - Dosage time explanation

IN-LINE Sensor Operation Error (A):

1. If the IN-LINE detergent sensor does not detect chemical within the prime cycle, then a flashing yellow bottle symbol appears on the operation screen indicating a "LOW DETERGENT ALERT", (Fig. 34).
2. Check the chemical supply then press the flashing bottle to run the prime cycle again.
3. The flashing yellow bottle will disappear when the IN-LINE sensor detects chemical.

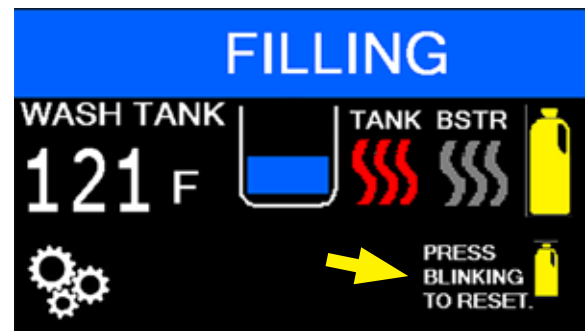

Fig. 34 - LOW DETERGENT ALERT - (flashing bottle)

IN-LINE Sensor Operation Error (B):

1. The detergent pump runs for 3 secs. before each wash cycle. If the IN-LINE sensor does not detect chemical after three consecutive cycles, the flashing yellow bottle will appear.
2. Check the chemical supply and press the flashing yellow bottle to reset the alert.

Factory Default Dosage Chart:

Detergent Base Type	Concentration	Prime	Fill	Cycle	Inline Conductivity Setting mV
Potassium Carbonate (Carbonate of Potash)	5 – 10 %	40	30	3	300
Sodium Hydroxide (Lye)	10 – 30 %	40	4	1	300



Repeating "LOW DETERGENT ALERT":

The flashing yellow bottle will continue to reset and periodically reappear until the cause of alert is repaired. The dishwasher continues operating even with the error.

Optional Champion Chemical Dispenser Set-up (continued)

Instructions for the Supervisor and Chemical Supplier

TANK Sensor (ONLY) Normal Operation:

1. Detergent pump output = 3ml/sec.
2. FILL: When the lower float is satisfied, detergent pump runs for set time for initial charge of detergent.
3. CYCLE: The detergent pump runs for a set time to maintain levels at the beginning of each wash cycle. Maintaining conductivity.

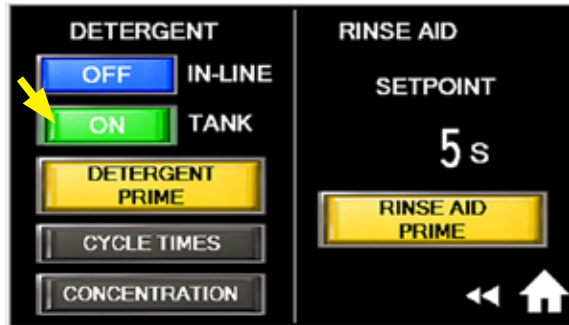

Fig. 35 - Tank sensor selected.

TANK Sensor Error Operation:

1. If machine has run one cycle, and tank temperature is 150°F/65.6°C or greater, and the tank conductivity sensor is not satisfied, then the detergent pump will pump the cycle time set point.
2. Detergent pump waits 20 secs. and pumps the cycle time set point again or until the tank conductivity sensor is satisfied.
3. When the wash pump is running, the detergent pump will run If the sensor detects the detergent is below its conductivity set point for 5 consecutive seconds.
4. This is repeated for two minutes or until tank sensor is satisfied. The flashing yellow bottle "LOW DETERGENT ALERT" will appear if tank sensor is not satisfied within two minutes, (pg. 19, Fig. 37).



Machine determines tank concentration by measuring conductivity. Refer to Page 14, Graph 1 and Graph 2 for correlation to PPM. Refer to Page 20 for adjustment process. Chemical settings are to be set to chemical mfg. requirements per titration results.

Factory Default Dosage Chart:

Detergent Base Type	Concentration	Prime	Fill	Cycle	Tank Conductivity Setting mV
Potassium Carbonate (Carbonate of Potash)	5 – 10 %	40	30	3	300
Sodium Hydroxide (Lye)	10 – 30 %	40	4	1	300

Optional Champion Chemical Dispenser Set-up (continued)

Instructions for the Supervisor and Chemical Supplier

IN-LINE and TANK Sensors Normal Operation:

1. Detergent pump output = 3ml/sec.
2. PRIME: Detergent pump will run for set time or until the in-line sensor detects chemical.
3. FILL: When the lower float is satisfied, detergent pump runs for set time for initial charge of detergent.
4. CYCLE: The detergent pump runs for a set time to maintain levels at the beginning of each wash cycle. Maintaining conductivity.



Fig. 36 - In-line and Tank sensor selected.

IN-LINE and TANK Sensor Operation Error:

1. If machine has run one cycle, and tank temperature is 150°F/65.6°C or greater, and the tank sensor is not satisfied, then the detergent pump will pump the cycle time set point.
2. Detergent pump waits 20 secs. and pumps the cycle time set point again or until the sensor is satisfied.
3. When the wash pump is running, the detergent pump will run if the sensor detects the detergent is below its set point for 5 consecutive seconds.
4. This is repeated for two minutes or until tank sensor is satisfied. The flashing yellow bottle "LOW DETERGENT ALERT" will appear if tank sensor is not satisfied within two minutes.

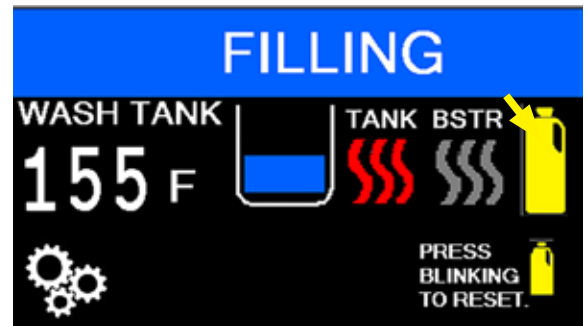

Fig. 37 - LOW DETERGENT ALERT - (flashing bottle)

Factory Default Dosage Time Chart:

Detergent Base Type	Concentration	Prime	Fill	Cycle	Tank Conductivity Setting mV	Inline Conductivity Setting mV
Potassium Carbonate (Carbonate of Potash)	5 – 10 %	40	30	3	300	700
Sodium Hydroxide (Lye)	10 – 30 %	40	4	1	300	700

Optional Champion Chemical Dispenser Set-up (continued)

Instructions for the Supervisor and Chemical Supplier

SET DETERGENT CONCENTRATION -- Applies to Tank or Inline Sensor Equipped Machines Only (Fig. 38):

The detergent dose and supply-based concentration is managed by time and conductivity probe(s), respectively.

1. Set-up by pressing the "CONCENTRATION" button, (Fig. 38), then set the needed values with reference to Page 14, Graph 1 or Graph 2, with regard to titration results. The concentration display indicates the sensor that is ON.
2. Set point value sets the amount of detergent injected.
3. Actual is the amount of detergent detected by sensor.
4. Press DETERGENT PRIME to prime in the event that it was not completely primed automatically.
5. Press "PUMP" button to agitate wash tank.
6. Fill the dishwasher with fresh water and run cycles until the tank temperature indicates approximately 160°F/71°C.



Fig. 38 - Detergent Concentration

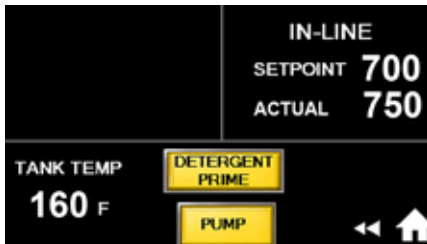

Fig. 39a - Only In-line Sensor ON



Fig. 39b - Only Tank Sensor ON

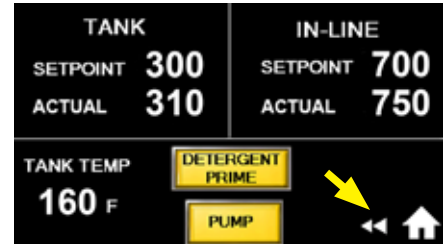

Fig. 39c - Tank and In-line Sensors ON

7. Press the 'Back-up button' (◀◀), (Fig. 39c), to return to the Supervisor menu, (Fig. 40).
8. Press the 'Home' button, (Fig. 40), to return to the main operation screen, (Fig. 41).



Fig. 40 - Home button



Fig. 41 - Main operation screen

THIS COMPLETES THE OPTIONAL CHAMPION CHEMICAL DISPENSER SETUP PROCEDURE.

SLEEP

 **NOTE:** Access to the supervisor menu is active for five minutes. The 7777 password must be re-entered after 5 minutes.

1. Press the SETTINGS button, "gears", (Fig. 42).
2. The Supervisor Menu appears, (Fig. 43).
3. Press the SETUP OPTIONS and the password screen appears, (Fig. 44).
4. Enter 7777 and ENT on the keypad (Fig. 45).
5. Setup Options screen appears.
6. Press the SLEEP button, (Fig. 46).
7. Press ON or OFF to enable/disable the option.
8. Press the number to enter a minimum of 1 hour up to a maximum of 10 hours. Factory default setting is 2 hours, (Fig. 47).



Fig. 42 - Main screen



Fig. 43 - Supervisor menu



Fig. 44 - Password screen



Fig. 45 - Keypad (Enter 7777 and ENT).

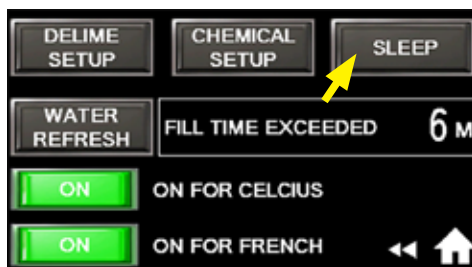

Fig. 46 - Press Sleep button

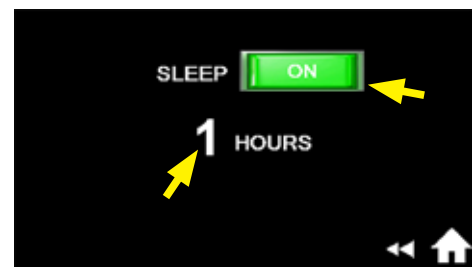

Fig. 47 - SLEEP setup screen.

9. During normal operation, if the machine is idle for the programmed time, then the main screen displays, "SLEEP" "TOUCH TO WAKE UP". (Fig. 48)
10. Touch the screen and the operation screen will reappear, (Fig. 42).
11. The tank heaters and the detergent system are disabled when the machine is asleep.

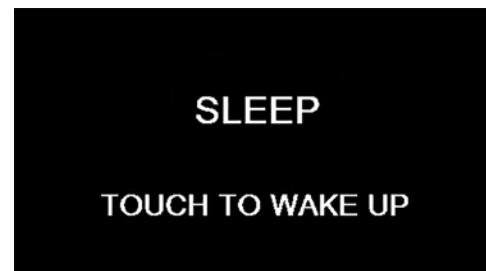

Fig. 48 - Main screen SLEEP display.

SUPERVISOR MENUS (continued)

FILL TIME EXCEEDED: The time it must take to fill the wash tank is programmed with the Fill Time Extended button. If the programmed minutes are exceeded then the operation screen displays an alarm.

ON FOR CELSIUS: When the button is ON temperatures are displayed in °C with the letter "C". By default, temperatures are displayed in °F with the letter "F" .

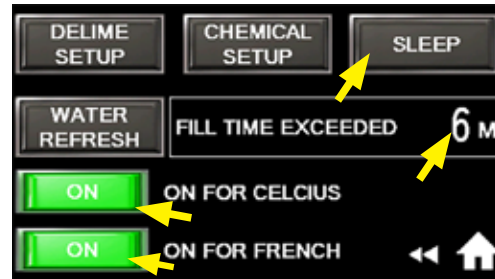

Fig. 49 - Selection buttons

ON FOR FRENCH: When the button is ON descriptions are displayed in French. By default, descriptions are displayed in English.

WATER REFRESH Water Refresh function ensures wash tank water remains clean to enhance washability by periodically draining one-third of the water in the wash tank and replacing with fresh water.

1. Press the Water Refresh button ON.
2. Press the set point number and enter the number the number of cycles before wash cycle begins.
3. Wash Cycle runs.
4. The next Refresh Cycle runs after the programmed wash cycles are complete.



Fig. 50 - Water refresh button

Water Refresh Cycle:

1. MACHINE washes normally. Drain valve opens at beginning of rinse and through 15 secs. of dwelling. Water level is 1/3 low.
2. Upper float is lowered. During next cycle, fill comes on to refill tank.
3. Booster temperature is low. Machine enters rinse sentry until booster temperature is satisfied.
4. Main screen displays the 'WATER REFRESH' alert.
5. Machine drains, refills, and washes normally.

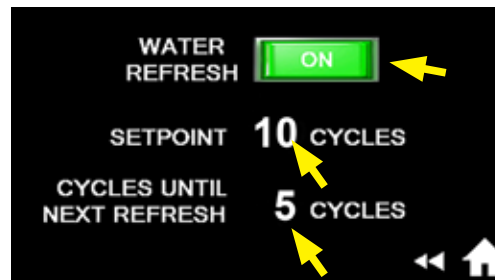

Fig. 51 - Adjustable refresh intervals

NAVIGATION BUTTONS:



- SETTINGS: Press for Supervisor Menu



- Back-up to previous screen.



- Return to main screen.

SUPERVISOR MENUS

I/O - Inputs/Outputs:

- The I/O shows the operating state of components.
- Machine operation can be checked using the I/O screen.



Fig. 52 - Press SETTINGS on main screen.

To access the I/O screen:

1. Press the SETTINGS button, "gears", on the main screen, (Fig. 52).
2. Press I/O button, (Fig. 53).
3. The I/O screen appears, (Fig. 54).
4. A red light indicates an open (inactive) condition. Green indicates closed (active).
5. For example, the green light for DOOR indicates the door is closed. The red light for PUMP indicates the pump is off.



Fig. 53- I/O button



NOTE:
Press the 'Back-up button (<<)' to return to the supervisor menu, (Fig. 54).



Fig. 54 - I/O SCREEN - Component status

ACTIVE FAULTS:

1. Press the ACTIVE FAULTS button to display operating errors currently present in the machine, (Fig. 55).



Fig. 55 - Active faults button

(continued on next page)

SUPERVISOR MENUS (continued)

ACTIVE FAULTS: (continued)

2. A green light indicates no fault, a red light indicates a fault is active, (Fig. 56).
3. Active faults are displayed on the operator's main screen. See the Operation Manual for details.



Fig. 56 - ACTIVE FAULTS screen

CYCLE COUNT:

1. Press the CYCLE COUNT button to display the total cycles run since commissioning, (Fig.57a-b).
2. The cycle count cannot be reset.



Fig. 57a - CYCLE COUNT button



Fig. 57b - Cycle count display



NOTE: Press the 'Back-up button' (◀◀).

MANUALS:

1. Press the MANUALS button to display operating and cleaning instructions, (Fig. 58).



Fig. 58 - Manuals

SUPERVISOR MENUS



NOTE:
Press the 'Back-up button' (◀◀).

REVISION:

1. Press the REVISION button, (Fig. 59a) to display the program version number installed.
2. The revision version is important for troubleshooting and repair of the machine.
3. The revision number, (Fig. 59b) automatically changes when a new program is installed.



Fig. 59a - Revision

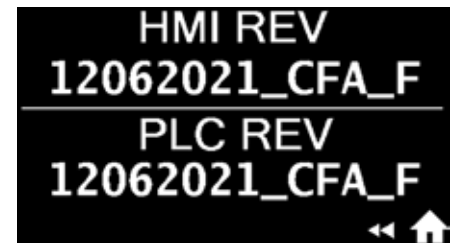

Fig. 59b - Revision Version

START DELIME:

1. Supervisors may start a Delime process from this menu. Users use the main screen to begin a Delime.
2. Press START DELIME to begin a delimiting operation, (Fig. 60).
3. The supervisor delime setup is on page 29.



Fig. 60 - Start delime

FACTORY SETUP

1. FACTORY SETUP CAN ONLY BE ACCESSED BY FACTORY PERSONNEL, (Fig. 61).
2. Contact Factory if this function is required.



Fig. 61 - Factory Setup not available for supervisors.

(continued on next page)

SUPERVISOR MENUS (continued)

MAINT:



CAUTION:
Supervisors should consult an authorized service agent before making changes to MAINT menu settings.

1. Press the SETTINGS button, "gears", to access supervisor menu, (Fig. 62).
2. Press the MAINT button, (Fig. 63).
3. The Enter Maintenance Password screen appears.
4. Press 0 and keypad appears (Fig. 64).
5. Press 9999, then 'ENT' on keypad,
6. The maintenance menu appears, (Fig. 66).



Fig. 62 - Main screen



Fig. 63 - MAINT button



Fig. 65 - MAINT password 9999.

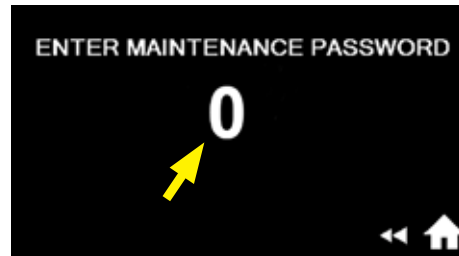

Fig. 64 - MAINT password screen

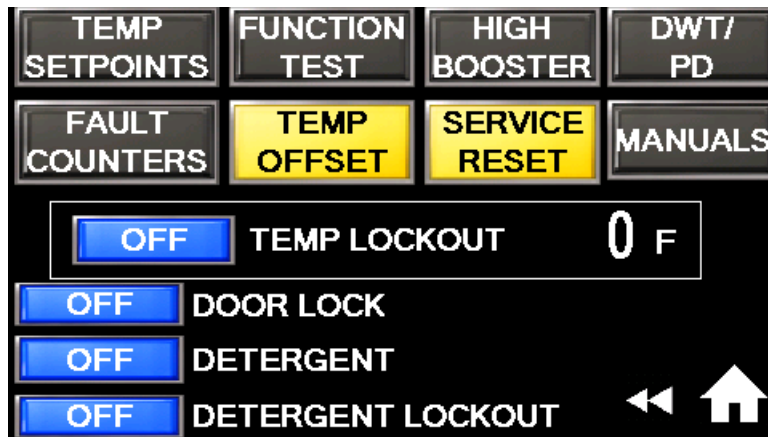

Fig. 66 - MAINT.

(continued on next page)

SUPERVISOR MENUS (continued)

MAINT: (continued)

TEMP SET POINTS:

1. Press the TEMP SET POINTS button, (Fig. 67a).
2. A menu appears showing the factory default Temperature Set points:
wash tank - 168°F/76.6°C
Booster - 191°F/88.3°C.
These can be adjusted by pressing the numeric values.
3. Actual Temperatures appear below and indicate the current temperatures during a wash and rinse cycle. These are not adjustable, (Fig. 67b).

Press the 'Back-up button (◀◀).

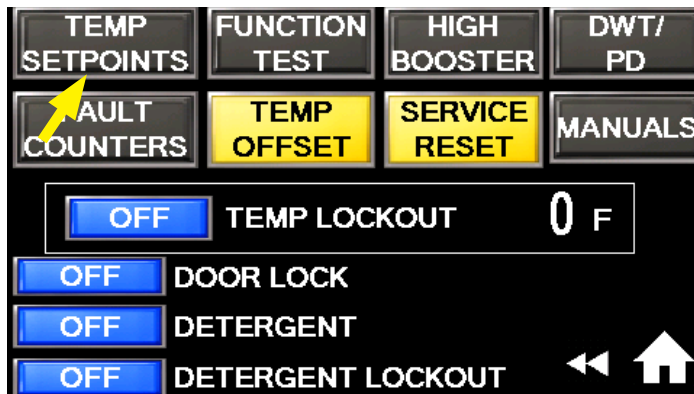

Fig. 67a - Maintenance menu

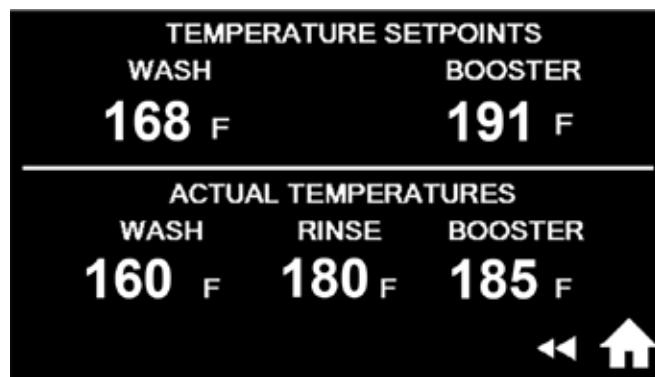

Fig. 67b - Temperature Set points menu

FUNCTION TEST:

1. Press the Function Test button, (Fig. 68).
2. A menu appears to test the displayed components on the screen. Press and hold the button to test if the component is working. Troubleshoot the problem or contact an authorized service agent for assistance.

Press the 'Back-up button (◀◀).

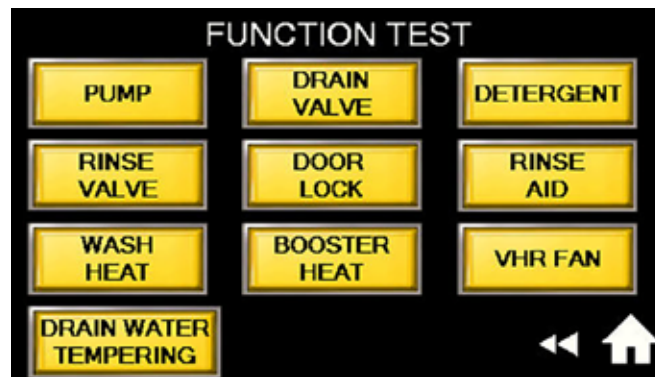

Fig. 68 - Function Test menu

HIGH BOOSTER:

1. Press the High Booster button, (Fig. 69).
2. Menu appears to display highest recorded booster temperature and any thermistor event causing a reading of > 3000. Tap button to test.
3. Contact service agent if problem.

(continued on next page)

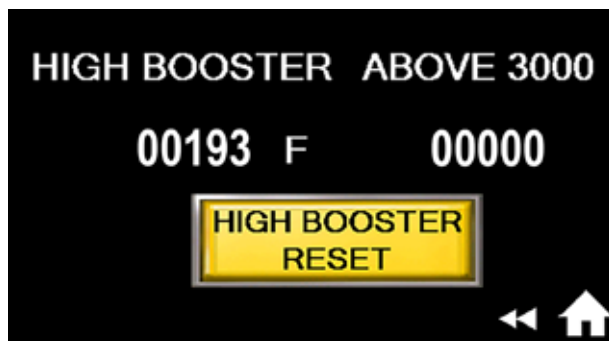

Fig. 69 - High booster menu

SUPERVISOR MENUS (continued)

FAULT COUNTERS:

1. The Fault Counter shows how many times the machine has a listed fault error.
2. Only a technician can reset fault counters.

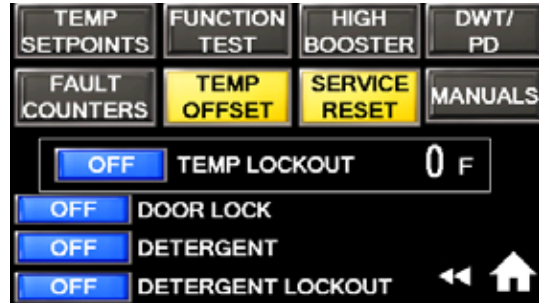

Fig. 70 - MAINT menu

TEMP OFFSET:

1. Temp Offset allows a service agent to compensate for variances between measured and actual temperature.
2. Only a technician can correct temperatures, (Fig. 71).



Fig. 71 - Only a technician can correct temperatures

DRAIN WATER TEMPERING (DWT):

(For electric Optional DWT only)

1. Drain water tempering is an option that includes a cold water valve connected to the drain line to cool the water leaving the machine.
2. Refer to Fig. 72. The default settings are OFF. The default time the cold water valve is energized during drain is 1 minute 30 secs. Default time during final rinse is a 5 sec. delay followed by a 20 sec. run time.

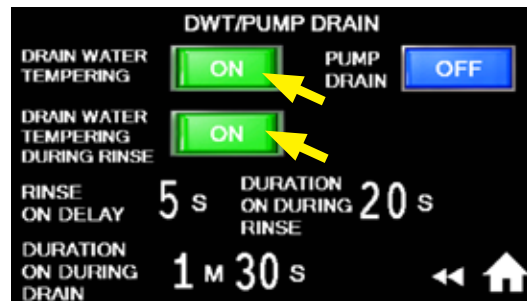

Fig. 72 - Drain water tempering settings



NOTE: The functions listed below are only used by service agents to program the operation of a machine if equipped with special options, (Fig. 70).

TEMP LOCKOUT: When ON, machine will prevent starting a wash cycle when wash tank temperature is below 150°F/65.5°C. The lockout temperature setting is adjustable.

DOOR LOCK: When ON, the door lock switch operates as required, if equipped.

DETERGENT: When ON, the Optional Champion detergent system is operational, if equipped.

DETERGENT LOCKOUT: When ON, the machine will not operate if detergent is not detected in the Champion detergent system, if equipped.

SUPERVISOR MENUS (continued)

DELIME SETUP:

 **NOTE:** Access to the supervisor menu is active for five minutes. The 7777 password must be re-entered after 5 minutes.

1. Press the SETTINGS button on the main screen, (Fig. 73).
2. Press SETUP OPTIONS button, Fig. 74).
3. ENTER SETUP PASSWORD screen appears, (Fig. 75).
4. Press 7777 and ENT, (Fig. 76).
5. Press DELIME SETUP BUTTON(Fig. 77).

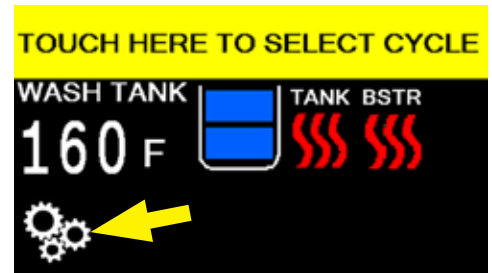

Fig. 73 - Main screen



Fig. 74 - Supervisor menu



Fig. 75 - Password screen



Fig. 76 - Keypad (Enter 7777 and ENT).



Fig. 77 - Delime Setup button

(continued on next page)

Supervisor Mode (MAINT): (continued)

DELIME NOTIFICATION SETUP:

1. DELIME SETUP activates and sets up the delime function.
2. Press the DELIME button The DELIME SCHEDULE sets the number of hours of machine operation between delime.
3. **HOURS** range = 10–100 hours. The factory default is 100.
4. **WASH DURATION MINUTES** range = 10–50 minutes. The factory default is 30 minutes.
5. **RINSE DURATION MINUTES** range is 10–30 minutes. The factory default is 30 minutes.



Fig. 78 - Delime Setup menu

To change a value:

1. Press the displayed number.
2. The keypad appears.
3. Press keypad and enter the desired value then press ENT.
4. Repeat for each number as needed.

START DELIME:



Fig. 79 - Supervisor's menu - Start delime button



Fig. 80 - Main screen Delime button

1. The Delime operation can be started from three locations:
 - a) Delime Setup screen, (Fig. 78).
 - b) Supervisor's menu, (Fig. 79).
 - c) Main screen, if the time to delime has elapsed and the machine is idle.
2. The delime operation is the same regardless of where the button is pushed.



DELIME OPERATION:

- Deliming removes mineral deposits from the machine with a deliming chemical.
- The deliming process is automatic after the chemical is added to the machine.
- Refer to Figs. 78 and 79 on the previous page.

START DELIME: (continued)

- The Delime process is semi-automatic. The operator must perform actions to prepare the process, then the machine performs the cleaning process automatically.



Fig. 81 - Press DELIME button to start

1. Press the DELIME button, (Fig. 81).
 2. "PROCEED WITH DELIME" screen appears.
 3. Press NO to return to main screen.
 4. Press YES to start delime, (Fig. 82).
- If door is open, "CLOSE DOOR TO START" appears, (Fig. 83). The red door icon in the upper right corner of the screen alerts the operator the door is open.
 - If door is closed when YES is pressed the screen immediately displays "DRAINING" and the machine drains, (Fig. 84).
5. When the machine has drained, open the doors and clean the scrap screens (Fig. 85).
 6. "CLOSE DOOR TO FILL" appears. Note the red door icon denoting an open door (Fig. 86).

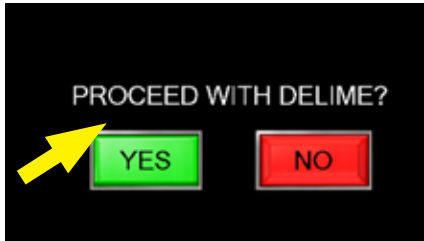

Fig. 82 - Proceed screen



Fig. 83 - Close door to start



Fig. 84 - Machine drains



NOTE: Press and hold the red button for three seconds to cancel delime and return to the main screen.



Fig. 86 - Close door to fill



Fig. 85 - Clean scrap screens

DELIME OPERATION: (continued)

7. Close the doors.
"FILLING" appears and machine fills, (Fig. 87).



CAUTION: Follow the chemical supplier's use and handling instructions. Wear protective clothing, and eye protection when handling chemicals.

8. "ADD DELIME CHEMICAL" appears (Fig. 88).
Open doors and add deliming chemicals in accordance with the chemical supplier's instructions.



NOTE: The operator cannot exit the deliming operation after the chemical is added.

9. "CLOSE DOOR TO START" appears (Fig. 89).
Red door icon indicates the doors are open.
10. "TIME REMAINING" indicates the length of time the deliming period will run and is set in the supervisor Delime Setup menu.
The time in this example is 10 minutes displayed in minutes and seconds (Fig. 89).
11. "DELIME IN PROGRESS" appears (Fig. 90).
Time remaining begins to count down to zero.



NOTE: If machine is equipped, the machine will lock the door until the deliming operation is finished.

12. Pump runs and circulates the delimer throughout the machine to remove mineral deposits, (Fig. 90).



NOTE: The delime operation can be stopped only by an authorized service agent.

13. Deliming time expires at end of preset time.
14. "DRAINING" appears. Pump stops, drain opens and deliming solution is drained.

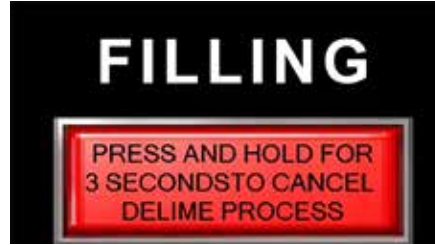

Fig. 87 - Machine fills

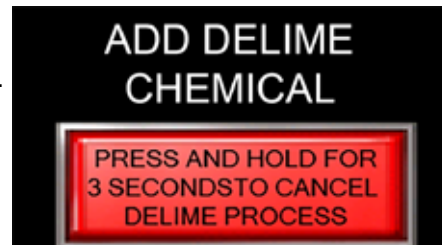

Fig. 88 - Add delime chemical

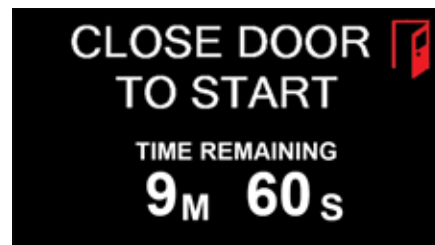

Fig. 89 - Close door to start delime operation



Fig. 90 - Pumps run

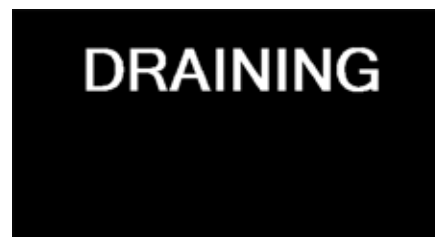

Fig. 91 - Delimer drains

(continued on next page)

DELIME OPERATION: (continued)

15. "FILLING" appears. Machine fills with fresh water, (Fig. 92).
16. "DELIME RINSE IN PROGRESS" appears. Pump runs. Time remaining in this example counts down from the preset 5 minutes, (Fig. 93).
17. "DRAINING" appears. Pump stops, drain opens and deliming residue drains, (Fig. 94).
18. "FILLING" appears. Machine fills, (Fig. 94).
19. "DELIME RINSE IN PROGRESS" appears for the second time to ensure delimer is removed. Pump runs. Time remaining counts down from the preset 5 minutes, (Fig. 95).
20. "DRAINING" appears for the final time. Machine drains.
21. "DELIME COMPLETE" appears. Press the "CONTINUE" button and the main screen will appear. The machine will fill and return to normal operation, (Fig. 98).

THIS COMPLETES THE SUPERVISOR MENU INSTRUCTIONS.



Fig. 92 - Fills with fresh water



Fig. 93 - Rinses to remove residue



Fig. 94 - Machine drains and refills again



Fig. 95 - Second rinse



Fig. 96 - Machine drains for final time

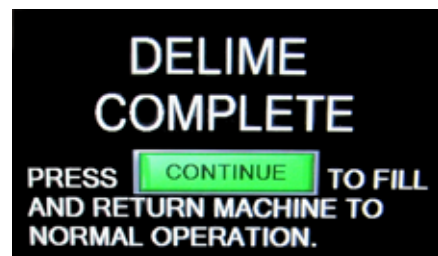

Fig. 97 -
Delime operation is complete.
Return to main screen.

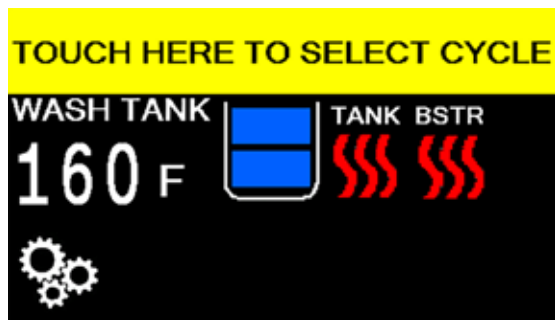



Fig. 98 - Main screen - normal operation

FAULT MESSAGES:

- Operation errors are displayed on the main screen with prompts to guide the operator through troubleshooting procedures and corrective actions.

FILL TIME EXCEEDED:

1. If the machine does not fill completely in the allotted time then "FILL TIME EXCEEDED" and a blinking fault icon appear, (Fig. 99a and Fig. 99b).
2. Press the  icon and an instruction screen appears. Follow the instructions and press RESET, (Fig. 99c).
3. The machine will resume normal operation or the fault screen will reappear.
4. Contact a service agent for repair.

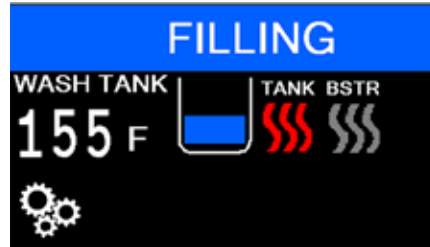

Fig. 99a - Normal FILLING operation screen

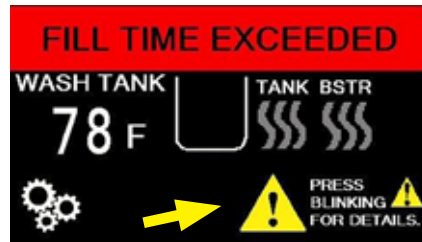

Fig. 99b - Fault screen with blinking icon

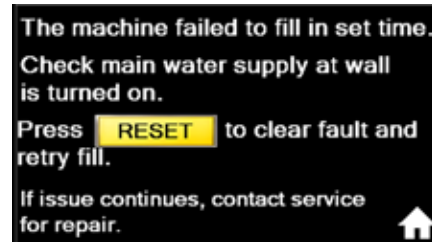



Fig. 99c - Follow instructions on screen

DRAIN TIME EXCEEDED:

1. If the machine does not drain completely in the allotted time then "DRAIN TIME EXCEEDED" and a blinking fault icon appear, (Fig. 100).
2. Press the blinking  icon and an instruction screen will appear. Follow the instructions and press ACKNOWLEDGE, (Fig. 100a).
3. If the drain fault is corrected then the machine will resume normal operation; however, if the fault is not corrected, the machine will resume normal operation with the blinking icon as a prompt that the machine is running in a drain fault condition and requires repair.
4. Contact a service agent for repair.

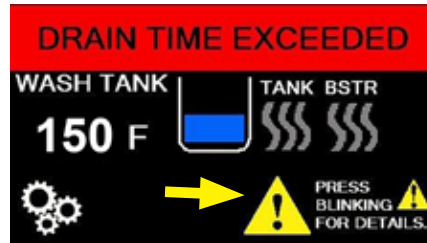

Fig. 100 - Error screen with blinking icon

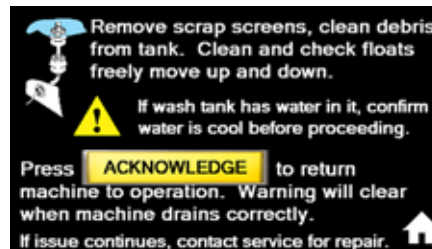

Fig. 100a - Follow instructions on screen



Fig. 100b - Main screen - normal operation with error icon

FAULT MESSAGES: (continued)

FLOAT FAULT:

1. The floats are devices inside the machine that control filling and heating. If a float encounters a problem, then "FLOAT FAULT" and a blinking fault icon appear, (Fig. 101).
2. Press the  icon and an instruction screen appears. Follow the instructions and press RESET, (Fig. 101a).
3. The machine will resume normal operation or the fault screen will reappear.
4. Contact a service agent for repair.



Fig. 101 - Fault screen with blinking icon

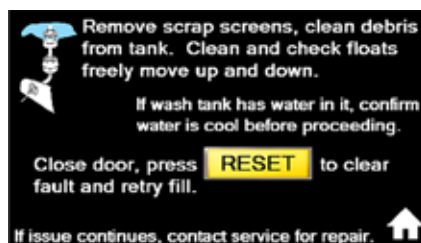

Fig. 101a - Follow instructions on screen

TEMPERATURE SENSOR FAULT:



1. If a machine temperature sensor fails, then the "TEMPERATURE SENSOR FAULT" message appears and the Wash Tank temperature displays **XXXX** indicating the location of the fault, (Fig. 102a).
2. Press the blinking  fault icon and an information screen appears. Press the ACKNOWLEDGE button, (Fig. 102b).
3. The machine will resume operation. The main screen in this example, has a blinking  fault icon, indicating the wash tank sensor is in a fault condition and the tank heater is de-energized,  (Fig. 102c).
4. Contact a service agent for repair.



Fig. 102 - Normal "WASHING" screen

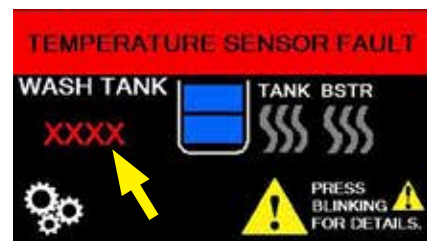

Fig. 102a - Temperature sensor fault screen



Fig. 102c - Main screen with blinking fault icon

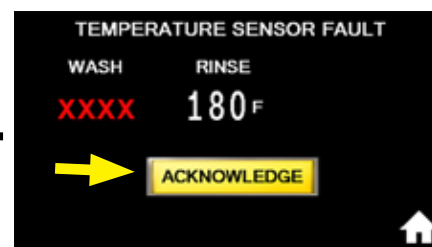

Fig. 102b - Press ACKNOWLEDGE

APPENDIX A: Installing DH6000T Corner Splash Shield Kit P/N 901114

INSTALLING DH6000T CORNER SPLASH SHIELD KIT, P/N 901114



CAUTION:

The machine will drain automatically when the dishwasher power is turned off.

KIT PARTS: (1) SHIELD, CORNER SPLASH, P/N 337955, COMPOUND SEALING, P/N 104889, (2) SCREWS, 10-32 X 1/2" TRUSS HEAD, P/N 100097, (2) WASHER, FLAT, 10-32, P/N 107033, NUT, GRIP, 10-32 W/NYLON INSERT, P/N 107966

SPECIAL TOOLS: #21 or 5/32" Drill bit, Electric Drill

1. The splash shield is installed on the right-hand side of the dishwasher, (Fig.1).

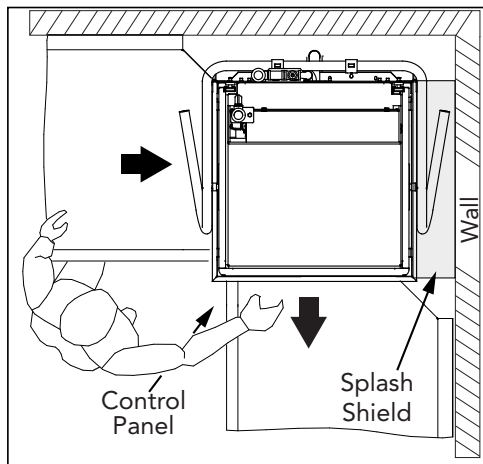

Fig. 1

2. Turn dishwasher power off; the machine will drain automatically. Open the doors.
3. Lift and remove the track assembly, (Fig. 2).



Fig. 2

APPENDIX A: Installing DH6000T Corner Splash Shield Kit P/N 901114

4. Remove the (4) bolts, locks, and washers securing the right-hand door guide cover. Save the fasteners and discard the cover, (Fig. 3).



Fig. 3

5. Install the splash shield between the door guide and the front corner post (Fig. 4). The left side of the splash shield covers the door guide.



Fig. 4

APPENDIX A: Installing DH6000T Corner Splash Shield Kit P/N 901114

6. Apply a small bead of sealing compound to the (4) fasteners saved in step 4. Secure the guide cover end of the splash shield to the machine, (Fig. 5).

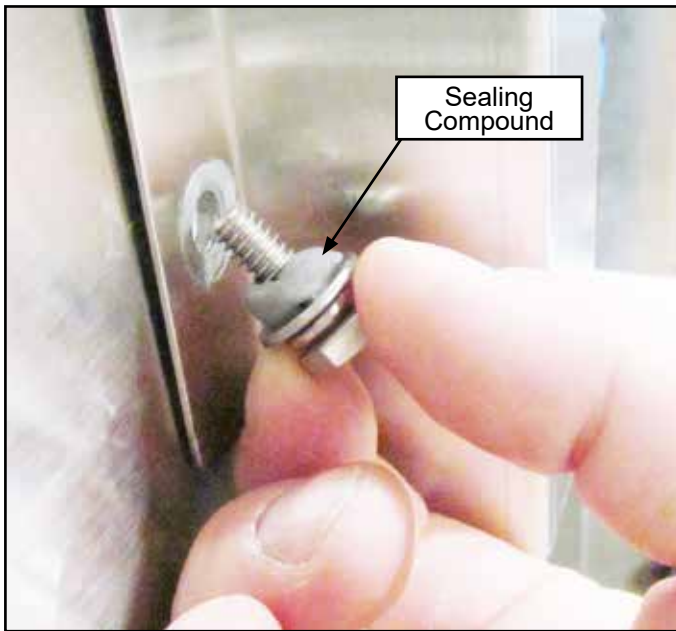

Fig. 5

7. Locate the mounting holes on the right-hand front corner, (Fig. 6).

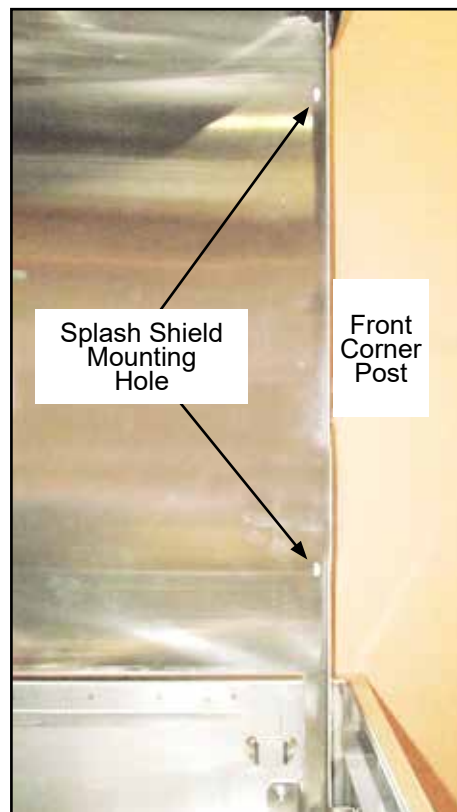

Fig. 6

8. Using the splash shield as a template, mark and drill two holes in the corner post. Secure the shield to the post using the 10-32 screws, nuts and washers provided in the kit.



Fig. 7

9. Open and close the doors to ensure there is no interference between the doors and shield.
10. Turn the dishwasher power on to fill the dishwasher.
11. The installation is complete.



NOTE:

The corner posts may be predrilled and will not require the posts to be drilled as described in Step 8.

Champion[®] Kit P/N 901168, DH6000/T-M2 Series
1-Point to 2-Point Terminal Block Conversion



ATTENTION

**CONTACT THE SERVICE
DEPARTMENT FOR A 2-POINT
CONNECTION DATA PLATE TO
GO INTO THIS KIT BEFORE
SHIPMENT.**

THIS KIT IS INCOMPLETE WITHOUT THE FOLLOWING:

- 1) FRONT PANEL 2-POINT CONNECTION DATA PLATE.
- 2) 2-POINT MACHINE ELECTRICAL CONNECTION DATA PLATE
- 3) 2-POINT BOOSTER ELECTRICAL CONNECTION DATA PLATE

Champion® Kit P/N 901242, DH6000/T- M2 Series 1-Point to 2-Point Terminal Block Conversion

KIT PARTS:

- (1) P/N 111833, Input Terminal Block
- (2) P/N 100007, Screw, 10-32 x 3/8" Truss Hd.,
- (1) *Label, Matrix 2-Point Electrical Data Plate,
- (1) P/N 117524, Instruction Sheet

*** THE DATA PLATE MUST BE CUSTOM PRINTED AT THE FACTORY AND ADDED TO THE KIT BEFORE SHIPMENT.**



WARNING:

Disconnect all power to the dishwasher before working on the machine.



Fig. 1

1. Check the contents of the kit, (Fig. 1). The new data plates must be included. Contact Champion National Service in USA @ 1-(800) 858-4477 or in Canada @ 1-(800) 263-5798.
2. Disconnect power to the dishwasher and remove the front and right-side panels. Locate booster terminal block mounting bracket on right front of machine base, (Fig. 2).
3. Install terminal block included in the kit to the existing bracket using kit screws, (Fig. 3).
4. Disconnect booster wires L1, L2, and L3 on main power terminal block and route to new booster terminal block and connect.
5. Connect booster line power to new terminal block.
6. Apply "2-Point Machine" connection data plate over the existing data plate and apply the "2-Point Booster" connection data plate in front of the booster terminal block, (Fig. 4).
7. Restore power and check machine operation.
8. Replace panels and apply new machine data plate over existing on lower front panel.
9. Restore power and check operation.
10. Conversion is complete.



Fig. 2 - Mounting bracket



Fig. 3 - Booster terminal block

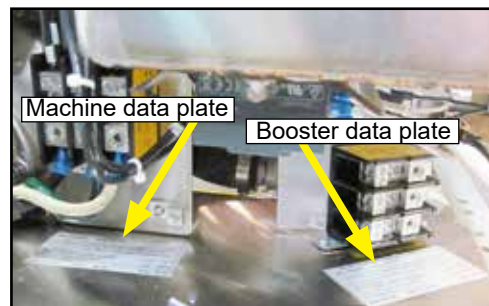

Fig. 4 - Apply 2-Point data plates

P/N 117014 ELECTRIC DRAIN VALVE MANUAL OPERATION



Type 1 - Without adjusting knob

Valve Position Sight Window



Valve Closed



Valve Open

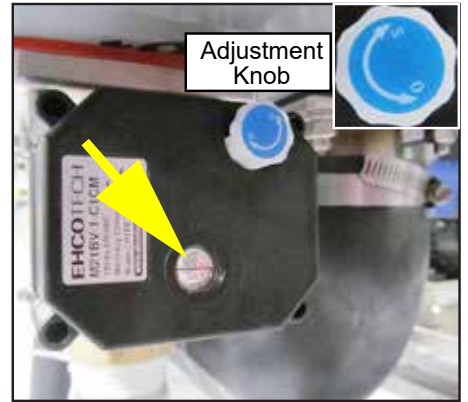

Type 2 - With adjusting knob



1
Remove four 2.5mm allen screws & remove coil from valve body.

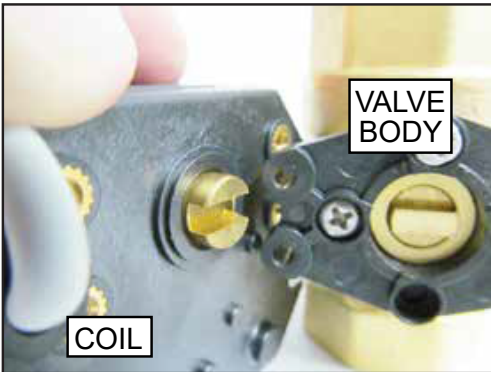

2
Note valve position is shown closed.

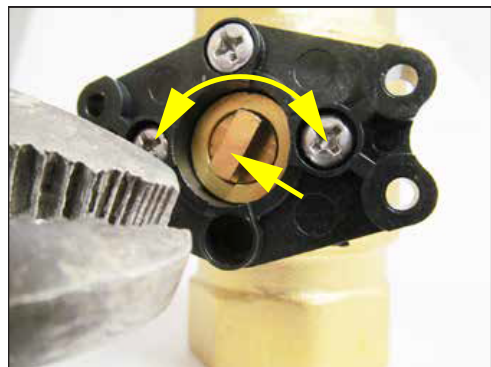

3
Turn valve body to adjust valve.

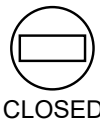

4 Reassemble in reverse order.



1
Pull adjusting knob out.



2
Rotate knob to open or close the valve.



3
Make sure the sight glass indicates the desired position.

Push the knob in.

**This page
was intentionally
left blank.**

