

Eyewash Faucet Installation Instructions

Installation instructions for 8450, 8451 and 8452 series faucets

Overview

Chicago Faucets integrated Eyewash Faucet features a cast brass body and precision cartridges for years of reliable operation.

Notice to the Installer

- Read this entire instruction sheet before installing to ensure proper installation.
- Installation must comply with local codes and ordinances.

Pressurized plumbing fixtures shall be installed in accordance with manufacturer's recommendations. The supply piping of these devices shall be securely anchored to the building structure to prevent installed device from unnecessary movement when operated by the user. Care shall be exercised when installing the device to prevent marring the exposed surface.

NOTE: The information in this manual is subject to change without notice.

Please leave this manual with the facility manager after completing the faucet installation. This document contains information necessary for routine maintenance and servicing.

NOTE: Before installation, turn off water supplies to existing faucet and remove faucet if replacing. Clean faucet basin and clear away debris. Flush all supply lines before connecting to faucet. Failure to do so can result in debris clogging the inlets and/or cartridges.

Emergency Equipment Location

Placement of Emergency Eyewash equipment must comply with these items:

- Must be mounted so that the flushing fluid flow pattern is not less than 33 in. (83.8 cm) and not greater than 53 in. (134.6 cm) above the floor level where the user will stand.
- Install the equipment as near as possible to areas where an accident is most likely to occur, e.g., near where hazardous material are stored or used. In an emergency, it should take no more than 10 seconds to reach the equipment.
- Place the equipment on the same level as the source of danger, without any obstruction in the pathway such as doors or stairways.

Water Supply

The water supply to the Emergency Eyewash equipment should meet the following conditions:

- Water must be supplied directly from the main or dedicated emergency piping that supplies potable water or water of similar quality.
- An inlet pressure of 50psi is recommended. For proper operation, the minimum pressure is 22 psi (1.5 bar), and the maximum pressure is 116 PSI (8 bar).
- Flush and drain the supply line before installing the Emergency Eyewash. An inline water filter is recommended.

NOTE: Water supply must be tepid water with a temperature between 50°F and 90°F (10°C and 32°C) to comply with ANSI standards.

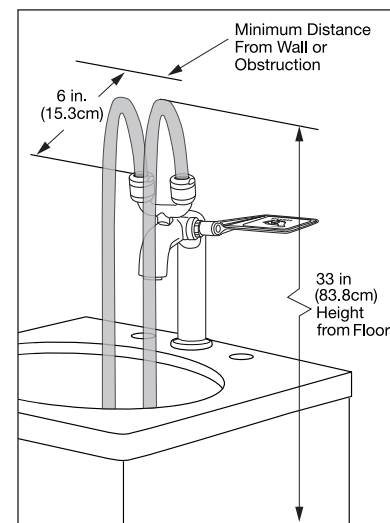
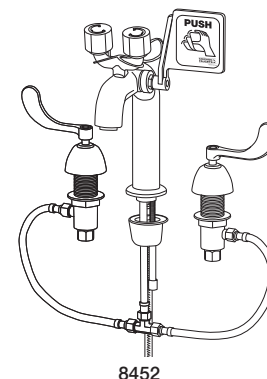
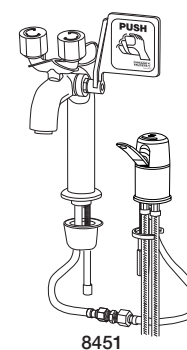
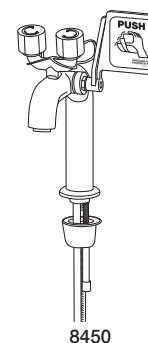

Valve Installation: 8451 and 8452 models shown. 8450 retrofit assumes valves currently installed.

8451 Single Handle

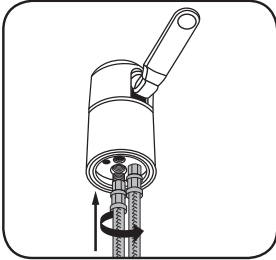

1. Thread the stainless steel hoses into the body and hand tighten securely. Do not over tighten.

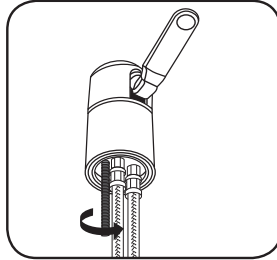

2. Thread 1/4"-20 mounting stud fully into the body, hand-tighten.

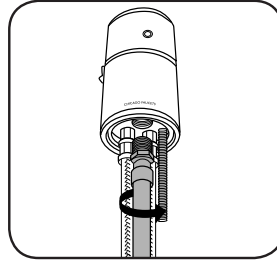

3. Attach connector hose to threaded adapter on valve.

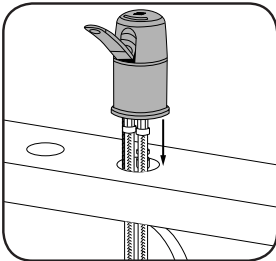

4. Place valve body onto sink with stainless steel hoses and connector hose through mounting hole. Use plumbers putty to seal faucet to sink

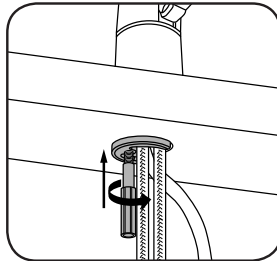

5. Place hold-down washer (solid surface facing downward) onto mounting stud from below and secure with mounting nut.

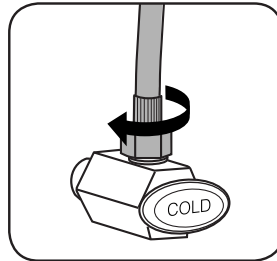

6. Connect the supply hoses to the water supply. Then proceed to spout installation.

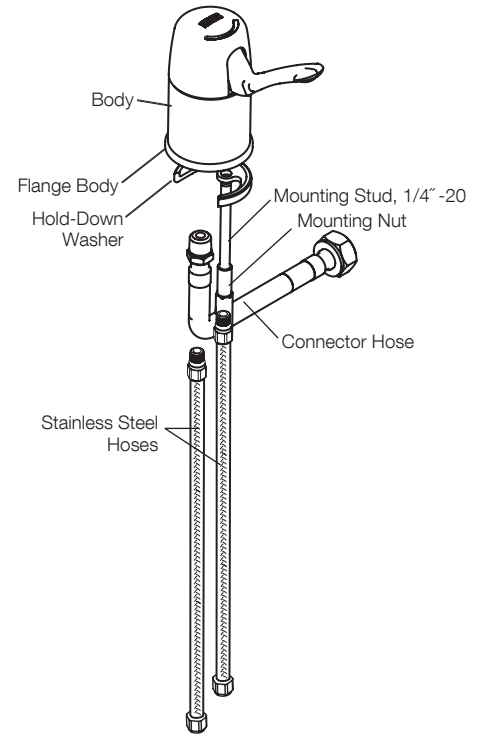

Installation - 8452 Dual Handle

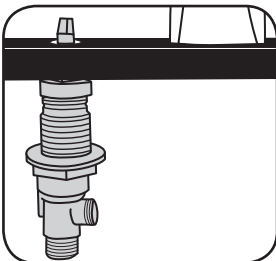

1. From below deck, push left handle stem through deck hole.

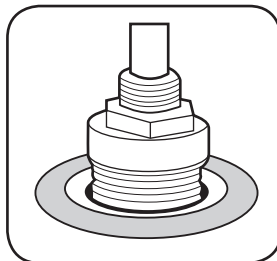

2. Above deck, place a sealing washer over the handle stem.

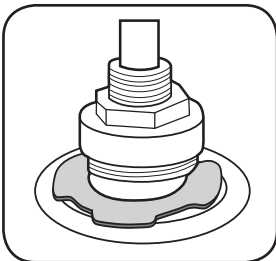

3. Slide a retaining clip on top of the sealing washer and into the groove of the handle stem.

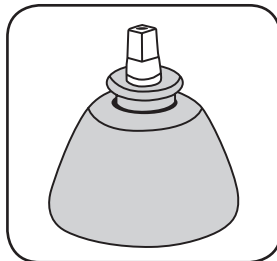

4. Install the escutcheon and secure with nut. Repeat these steps with the right handle stem.

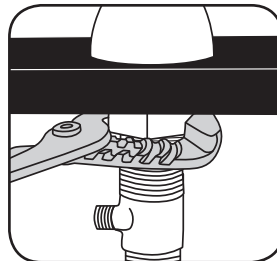

5. Below deck, hand tighten the flanged nuts and then with a wrench tighten 1/4 - 1/2 turn more.

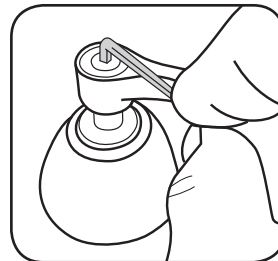

6. Install handles and adjust to 90° if necessary.

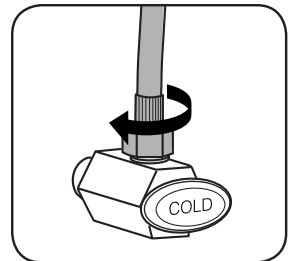

7. Connect the supply hoses to the water supply. Then proceed to spout installation.

Exploded View

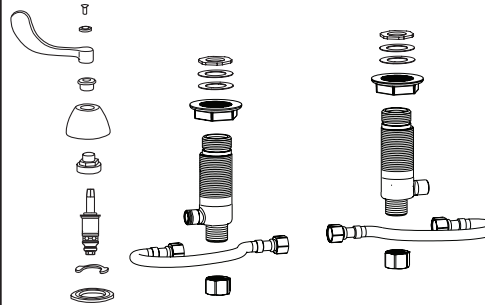
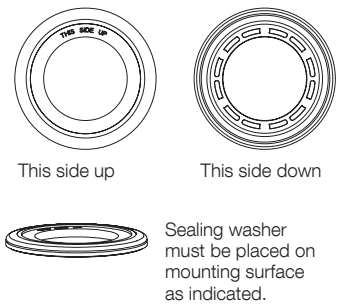
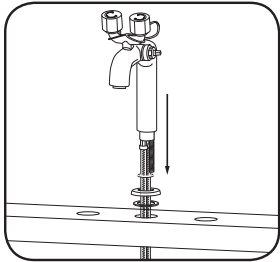

ILLUSTRATION A



Installation – Eyewash Faucet Body



1. Place spout with gasket and escutcheon with o-ring and hoses through hole in deck.

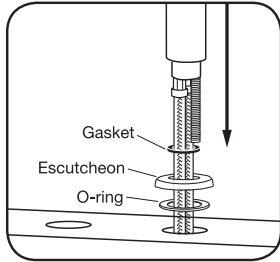

2. Lower assembly to deck and verify proper seating.

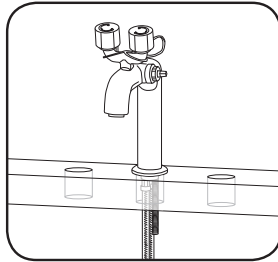

3. Position spout so that it is square with backsplash.

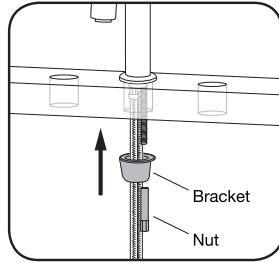

4. Place hoses and threaded rod through bracket.

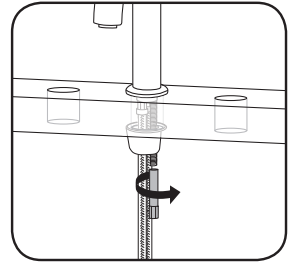

5. Tighten nut so that gasket is fully depressed with no movement in spout.

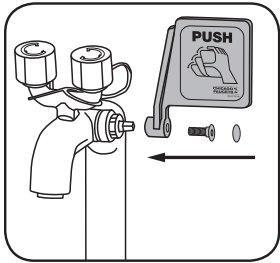

6. Assemble push paddle with supplied screw.

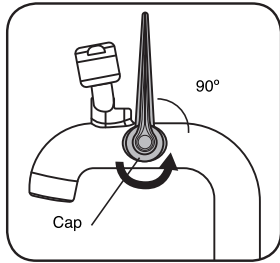

7. Make sure that the paddle is at 90° vertical. Adjust as necessary by loosening cap, setting at 90°, then tightening cap.

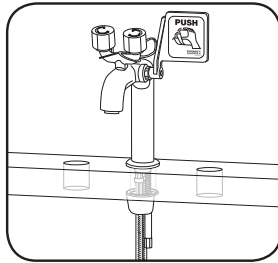

8. Spout is now ready to connect with valve assemblies.

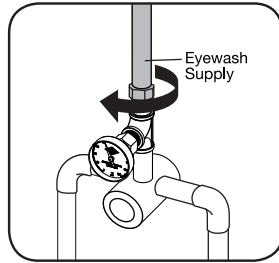

9. Connect the eyewash supply (designated by red tag) to the tempered water supply line.

NOTE: If your installation includes an ASSE 1071 compliant tempering valve, please see the instructions provided with the valve for proper connection to the eyewash fitting.

Installation – Connecting to 8451

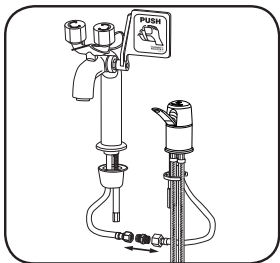

1. Connect the single lever valve to the faucet using the 3/8" to 1/2" adapter provided.

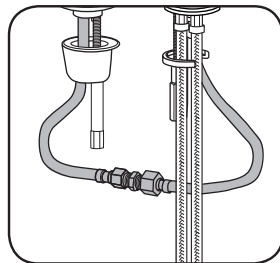

2. Tighten all hoses to the adapter and check for leaks. Flush lines after installation.

Installation – Connecting to 8452

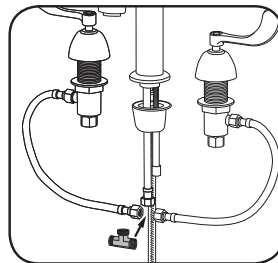

1. Attach 2 valve body hoses and faucet hose to 3/8" tee adapter.

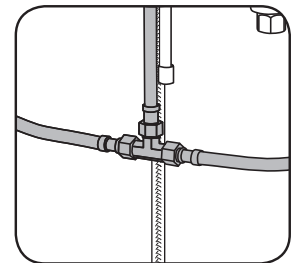

2. Tighten all hoses to the adapter and check for leaks. Flush lines after installation.

Testing unit – Eyewash

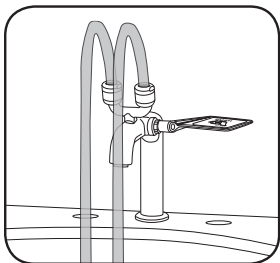

1. Flush eyewash portion of faucet. Activate by pushing on paddle. The paddle should move freely, with no resistance during activation.

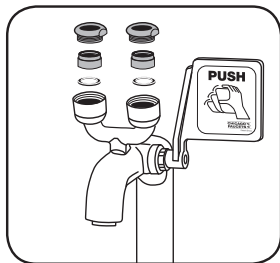

2. Install washer, aerator, and eyewash cap assembly. Secure into place.

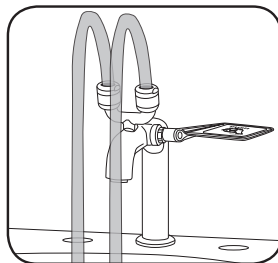

3. Activate again. Ensure water flows in a smooth, consistent stream. Use a thermometer to check water temperature. **Note: must be between 50°F and 90°F.**

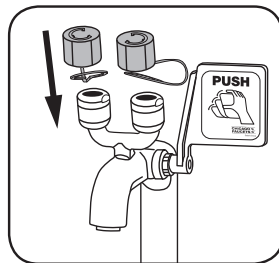

4. Pull paddle back to stop flow and place eyewash covers on faucet.

Maintenance

Proper operation of the Emergency Eyewash equipment should be verified at least once a week to confirm the water supply to the fitting and prevent the proliferation of bacteria in the system.

A record of maintenance should be maintained. A maintenance card is supplied with the fitting and can be attached to the fitting for easy reference.

All personnel in the facility where the Emergency Eyewash equipment is installed should be trained about:

- The location of the equipment, including signage (see below)
- Proper operation of the equipment
- Procedures for contacting emergency personnel
- Performing regular maintenance on the equipment

Signs

Every Emergency Eyewash fitting is provided with a sign that indicates the function of the equipment. The signs have a dark green background and photoluminescent white illustration to make it easy for personnel to find the equipment in an emergency. Mount the sign near the faucet so it is easily visible.



Adjustments

8451 series

Temperature and Volume Adjustment Disassembly

1. Using a 3/32" hex key, remove the hex screw and cap.
2. Remove the Phillips screw and handle.
3. Squeeze the tab clips and push forward to separate the spin cap halves.

Temperature Adjustment

NOTE: Cartridge is supplied with hot limit ring in the middle position. To save hot water and avoid scalding, the ring may be adjusted so the ring pin contacts the stop before the faucet handle reaches the full hot water position.

4. Lift the temperature adjustment ring off the cartridge.
5. Rotate the ring clockwise to decrease hot water flow or counterclockwise to increase hot water flow. Reposition the ring onto the cartridge.

Volume Adjustment

6. Loosen the set screw in the back of the cartridge stem.
7. Volume set screw is factory preset to full open. Turn set screw counterclockwise to restrict water flow.

NOTE: Volume adjustment can be done by removing cap, screw and LH spin cap, without removing cartridge from faucet.

Assembly

8. Assemble the LH and RH spin caps with the spin rings inside the grooves. LH spin cap is located above the set screw.
9. Install the handle and make sure it is seated with the cartridge stem, then secure with screw.
10. Install the cap and hex screw.

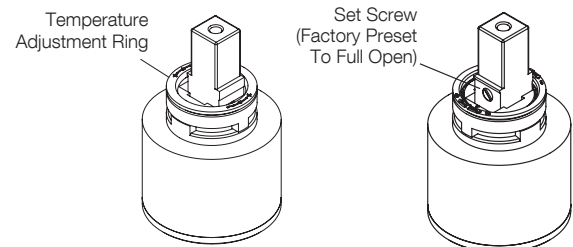
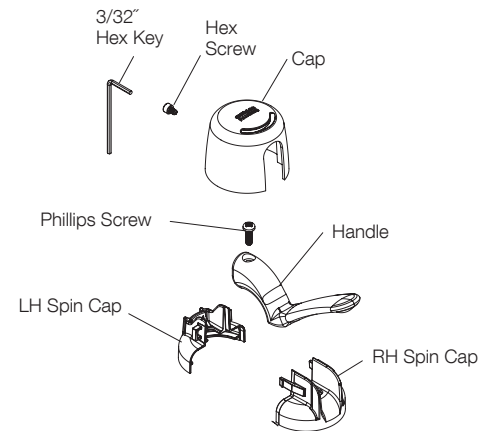

Care and Maintenance

All Chicago Faucets fittings are designed and engineered to meet or exceed industry performance standards.

Care should be taken when cleaning this product. Do not use abrasive cleaners, chemicals or solvents as they can result in surface damage. Use mild soap with warm water for cleaning and protecting the surface of Chicago Faucets fittings.

For additional technical assistance, call 800/TEC-TRUE (800-832-8783) or visit our website at chicagofaucets.com.

CHICAGO FAUCETS LIMITED WARRANTY

TO WHOM DOES THIS WARRANTY APPLY? — The Company extends the following limited warranty to the original user only.

WHAT DOES THIS WARRANTY COVER AND HOW LONG DOES IT LAST?

This warranty covers the following Commercial Products:

LIFETIME FAUCET WARRANTY — Any metal cast, forged, stamped or formed portion of the Product, not including electronic or moving parts or other products separately covered by this Limited Warranty or water restricting components or other components, is warranted against material manufacturing defects for the life of the Product.

FIVE YEAR FAUCET WARRANTY — Certain Products or portions of the Product are warranted against material manufacturing defects for a period of five (5) years from the date of Product purchase. Products warranted against material manufacturing defects for a period of five (5) years from the date of Product purchase are referred to by the product series 90, 99, 150, 410, 420, 430, STB, STC, W4D, W4W, W8D, W8W, 1900, 1905, SH, 537, 548, 549, 640, 897, 2500, 8400, 9800 and E-Tronic™.

FIVE YEAR CARTRIDGE WARRANTY — The "Cartridge", defined as the metal portion of any Product typically referred to by the product numbers containing 1-099, 1-100, 217, 274, 313, 333, 335, 376, 377, 386, 408, 409, 617, 625, 628, 667, 670, 671, 672, 745, 776, 807, 824, 825, 826, 919, 937, 962, 966, 977, 1105, 2500, 3300 and 5235 excluding any rubber or plastic components, is warranted against material manufacturing defects for a period of five (5) years from the date of Product purchase.

ONE YEAR FINISH WARRANTY – COMMERCIAL — For Products used in commercial applications, the finish of the Product is warranted against material manufacturing defects for a period of one (1) year from the date of Product purchase.

OTHER WARRANTIES — All other Products not covered above are warranted against material manufacturing defects for a period of one (1) year from the date of Product purchase. For complete warranty details, call Chicago Faucets Customer Service at 847-803-5000 or visit chicagofaucets.com.

The Chicago Faucet Company
2100 South Clearwater Drive
Des Plaines, IL 60018
Phone: 847/803-5000
Fax: 847/803-5454
Technical: 800/832-8783
www.chicagofaucets.com