

Widespread Fittings Installation Instructions

Recommended for base numbers: 201, 786

**CHICAGO
FAUCETS**
Geberit Group

Overview

Chicago Faucets deck mounted faucets feature cast brass bodies and precision cartridges for years of reliable operation. Metering models with adjustable cycle time offer true water savings.

Notice to the Installer

- Read this entire instruction sheet before installing to ensure proper installation.
- Installation must comply with local codes and ordinances.

Pressurized plumbing fixtures shall be installed in accordance with manufacturer's recommendations. The supply piping to these devices shall be securely anchored to the building structure to prevent installed device from unnecessary movement when operated by the user. Care shall be exercised when installing the device to prevent marring the exposed surface.

NOTE: The information in this manual is subject to change without notice.

Please leave this manual with the facility manager after completing the faucet installation. This document contains information necessary for routine maintenance and servicing.

NOTE: Before installation, turn off water supplies to existing faucet and remove faucet if replacing. Clean faucet basin and clear away debris. Flush all supply lines before connecting to faucet. Failure to do so can result in debris clogging the inlets and/or cartridges.



Exploded Views:

Tall Stem Cartridge

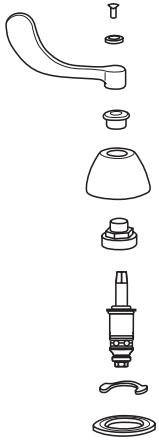

Short Stem Cartridge



Metering

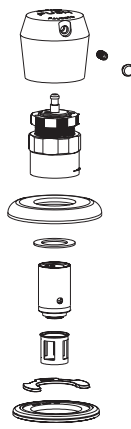

Other Configurations:

8" Rigid

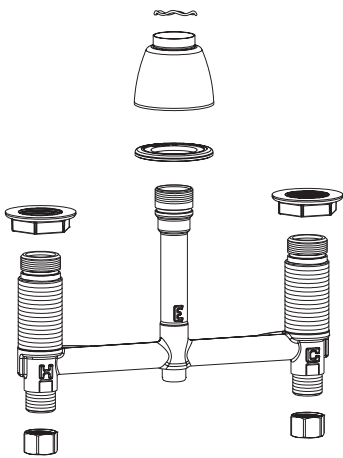

8" Rigid with Third Water Hook-up

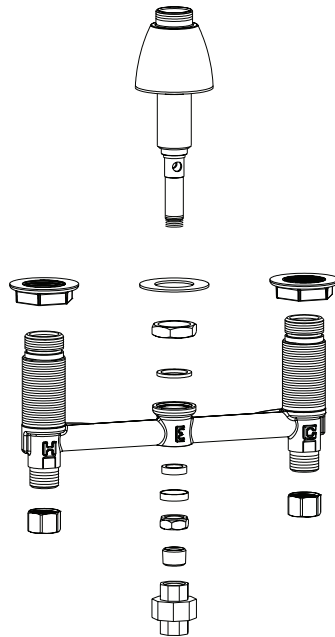

One-Piece Body Installation

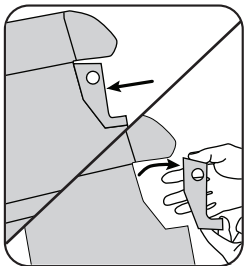

1. To help with the installation, the faucet carton features a perforated hanger. Carefully separate it from the carton.

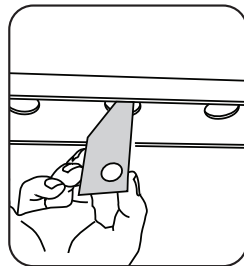

2. Insert the hanger through the spout hole of the sink or mounting surface.

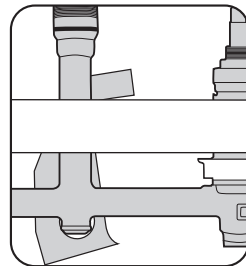

3. Use the hanger to hold the body in place while you hand tighten the mounting nuts.

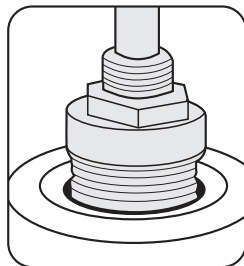

4. Place a sealing washer over each handle stem. Be sure to have recessed rim of washer facing up. See Illustration A.

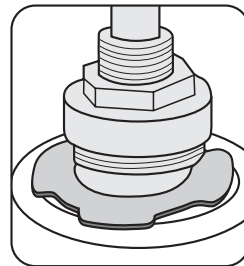

5. Insert retaining clips firmly into channel on each valve body. Remove hanger from spout hole.

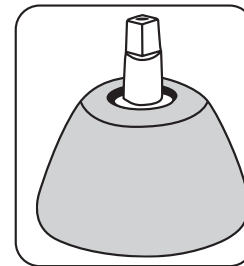

6. Place handle escutcheons over handle stems. Handles should cover the sealing washers.

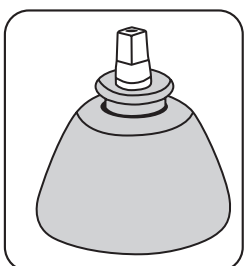

7. Place a hold-down nut onto each handle stem and hand tighten.

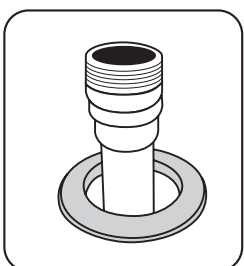

8. Place gray sealing washer over center spout post. Be sure the soft rib faces down.

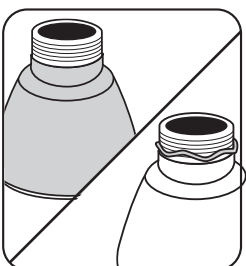

9. Place spout escutcheon over spout stem until it rests on the sealing washer. Place way washer on center spout post so it rests on top of spout escutcheon.

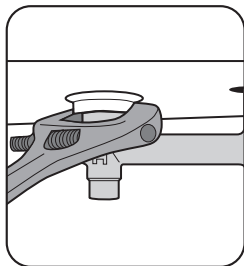

10. Using adjustable wrench, tighten underbody nuts.

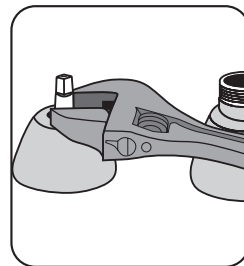

11. Using adjustable wrench, tighten handle hold-down nuts.

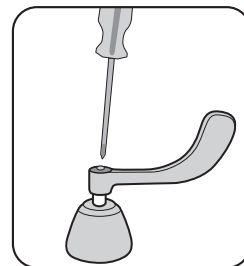

12. Align both handles on stem as desired. Insert index buttons, screws, and tighten.

ILLUSTRATION A

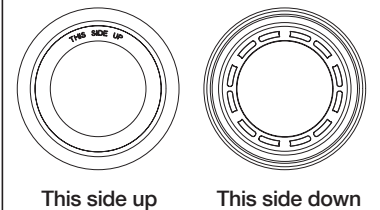

This side up

This side down



Sealing washer must be placed on mounting surface as indicated.

Widespread Fittings Installation Instructions

(continued)

Spout Installation

Swing Spout

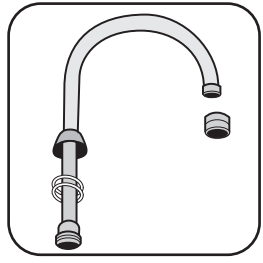

1. Remove outlet from spout. Place two split rings on spout near the base. Slide spout nut onto spout.

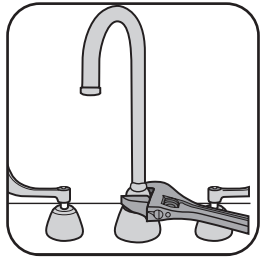

2. Place spout onto valve body until fully seated. Tighten spout nut with wrench. Connect water supplies, flush line, and attach outlet.

Rigid Spout

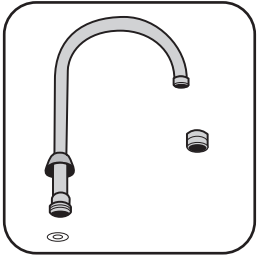

1. Remove outlet from spout. Slide spout nut onto spout. Place solid white washer into base outlet.

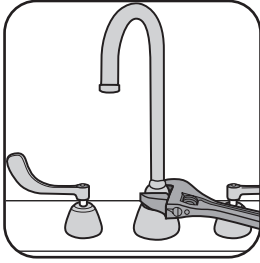

2. Place spout onto valve body until fully seated. Tighten spout nut with wrench. Connect water supplies, flush line, and attach outlet.

Restricted Swing Spout

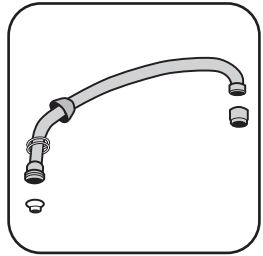

1. Remove outlet from spout. Place two split rings on spout tubing near base. Slide spout nut onto spout.

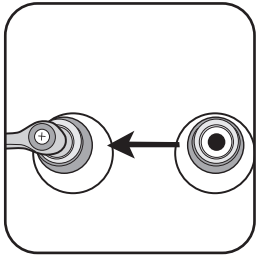

2. Place restricted swing adapter into valve body and align with internal valve body tab. Position small opening (70°) or large opening (120°) toward "hot" side of body.

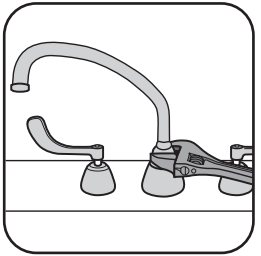

3. Place spout into stem. Tighten spout nut with wrench. Connect water supplies, flush line, and attach outlet.

FIGURE 'A'

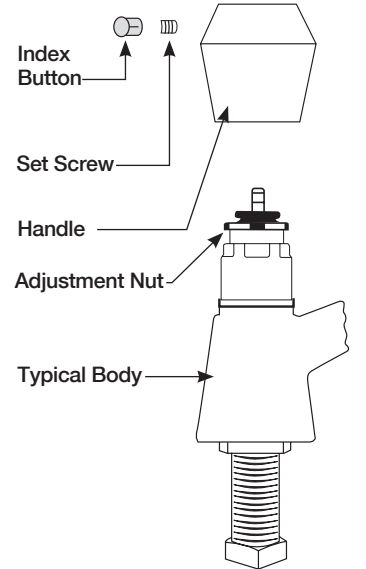
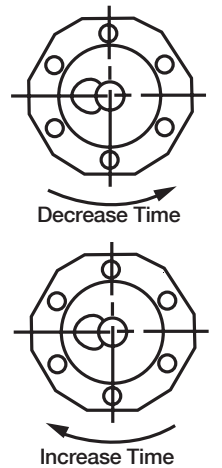

FIGURE 'B'

How To Adjust (Top View)



Timing Adjustment on an MVP Metering Cartridge

- With cartridge and handle installed in body and water supply turned on, purge cartridge of air by pushing handle completely down 4-8 times repeatedly, then check timing cycle.
- To change cycle time, remove index button, then handle using a 3/32 hex wrench. **(Figure 'A')**
- Using your fingers change height of adjustment nut by 1/4 turn only. Turn adjustment nut clockwise to increase cycle time or counter-clockwise to decrease cycle time. **(Figure 'B')**
- Replace handle and verify desired cycle time.
NOTE: TIMING MUST BE CHECKED WITH HANDLE IN PLACE.
- If additional adjustment is necessary, repeat steps 3 and 4 until desired cycle time is achieved.
- Attach handle and tighten screw. If index button is included, snap into handle.
NOTE: Some new installations might produce a slight closing noise. This is normally the result of air trapped in the cartridge and noise will dissipate over time.

MVP Metering Cartridges

- If filter and lower valve cartridge have been removed from fitting, replace them by inserting filter first.
- If gasket has been removed from the actuator assembly, replace it by inserting into bottom of actuator assembly.
- Assemble actuator assembly to body and tighten to 12-15 FT. LBS. torque.
- Assemble handle and check timing, adjust if necessary.
- Tighten set screw with a 3/32 allen wrench.
- Insert index button into handle.

Care and Maintenance

All Chicago Faucets fittings are designed and engineered to meet or exceed industry performance standards. Care should be taken when cleaning this product. Do not use abrasive cleaners, chemicals or solvents as they can result in surface damage. Use mild soap with warm water for cleaning and protecting the surface of Chicago Faucets fittings.

For additional technical assistance, call 800/TEC-TRUE (800-832-8783) or visit our website at chicagofaucets.com.

CHICAGO FAUCETS LIMITED WARRANTY

TO WHOM DOES THIS WARRANTY APPLY? — The Company extends the following limited warranty to the original user only.

WHAT DOES THIS WARRANTY COVER AND HOW LONG DOES IT LAST?

This warranty covers the following Commercial Products:

LIFETIME FAUCET WARRANTY — The "Faucet," defined as any metal cast, forged, stamped or formed portion of the Product, not including electronic or moving parts or other products separately covered by this Limited Warranty or water restricting components or other components, is warranted against material manufacturing defects for the life of the Product.

FIVE YEAR FAUCET WARRANTY — Certain Products and portions of the Product are warranted against material manufacturing defects for a period of five (5) years from the date of Product purchase. Products warranted against material manufacturing defects for a period of five (5) years from the date of Product purchase are referred to by the product numbers 42X, 43X, 15XX and E-Tronic™ - 4X, 5X, 6X, 7X, 8X and 9X. All zinc die cast portions of Product are warranted against material manufacturing defects for a period of five (5) years from the date of Product purchase.

THREE YEAR ELECTRONICS WARRANTY — Electronic components, including the solenoid, are warranted for three (3) years from the date of installation.

FIVE YEAR CARTRIDGE WARRANTY — The "Cartridge", defined as the metal portion of any Product typically referred to by the product numbers containing 1-099, 1-100, 1-310, 377X, 217X and 274X, excluding any rubber or plastic components, is warranted against material manufacturing defects for a period of five (5) years from the date of Product purchase. All Cartridges included in the Company's Single Control or Shower Products also are warranted against material manufacturing defects for a period of five (5) years from the date of Product purchase.

ONE YEAR FINISH WARRANTY - COMMERCIAL — For Products used in commercial applications, the finish of the Product is warranted against manufacturing defects for a period of one (1) year from the date of Product purchase.

OTHER WARRANTIES — All other Products not covered above are warranted against material manufacturing defects for a period of one (1) year from the date of Product purchase.

Other restrictions and limitations apply. For complete warranty details, call Chicago Faucets Customer Service at 847-803-5000 or visit chicagofaucets.com.

The Chicago Faucet Company
2100 South Clearwater Drive
Des Plaines, IL 60018
Phone: 847/803-5000
Fax: 847/803-5454
Technical: 800/832-8783
www.chicagofaucets.com