

Innovative Foodservice Equipment
Custom Designed for Performance, Service and Value.

INSTALLATION AND OPERATING INSTRUCTIONS

Tender Touch Classic

Solid State Controlled Slow Roast & Hold Ovens

INTENDED FOR OTHER THAN HOUSEHOLD USE
RETAIN THIS MANUAL FOR FUTURE REFERENCE
UNIT MUST BE KEPT CLEAR OF COMBUSTIBLES AT ALL TIMES



FOR YOUR SAFETY

Do not store or use gasoline or other flammable vapors and liquids in the vicinity of this or any other appliance.



WARNING

Improper installation, adjustment, alteration, service or maintenance can cause property damage, injury or death. Read the Installation, Operating and Maintenance Instructions thoroughly before installing or servicing this equipment.



WARNING

Initial heating of unit may generate smoke or fumes and must be done in a well-ventilated area. Overexposure to smoke or fumes may cause nausea or dizziness.



This equipment has been engineered to provide you with dependable service when used according to the instructions in this manual and standard commercial kitchen practices.



ANSI/NSF4

Form #780092 6/06

Phone: (214) 421-7366
Fax: (214) 565-0976
Toll Free: (800) 527-2100
Website: www.apwwyott.com
E-mail: info@apwwyott.com

BEVLES COMPANY, INC.
P.O. Box 1829
Cheyenne, WY 82003

IMMEDIATELY INSPECT FOR SHIPPING DAMAGE

All containers should be examined for damage before and during unloading. The freight carrier has assumed responsibility for its safe transit and delivery. If equipment is received damaged, either apparent or concealed, a claim must be made with the delivering carrier.

A) Apparent damage or loss must be noted on the freight bill at the time of delivery. It must then be signed by the carrier representative (Driver). If this is not done, the carrier may refuse the claim. The carrier should supply the necessary forms.

B) Concealed damage or loss if not apparent until after equipment is uncrated, a request for inspection must be made to the carrier within 15 days. The carrier should arrange an inspection.

BE CERTAIN TO HOLD ALL CONTENTS AND PACKAGING MATERIAL.

Installation and start-up should be performed by a qualified installer who thoroughly reads, understands and follows these instructions.

BevLes Company takes pride in the design and quality of our products. When used as intended and with proper care and maintenance, you will experience years of reliable operation from this equipment. To ensure best results, it is important that you read and follow the instructions in this manual carefully.



Installation and start-up should be performed by a qualified installer who thoroughly reads, understands and follows these instructions.



If you have questions concerning the installation, operation, maintenance or service of this product, write Technical Service Department BevLes Company, Inc., 729 Third Avenue, Dallas, TX 75226.



SAFETY PRECAUTIONS



Before installing and operating this equipment be sure everyone involved in its operation is fully trained and aware of all precautions. Accidents and problems can result by a failure to follow fundamental rules and precautions.

The following words and symbols, found in this manual, alert you to hazards to the operator, service personnel or the equipment. The words are defined as follows:

 **DANGER:** This symbol warns of imminent hazard which will result in serious injury or death. 



 **WARNING:** This symbol refers to a potential hazard or unsafe practice, which could result in serious injury or death. 



 **CAUTION:** This symbol refers to a potential hazard or unsafe practice, which may result in minor or moderate injury or product or property damage. 



 **NOTICE:** This symbol refers to information that needs special attention or must be fully understood even though not dangerous. 



GENERAL INFORMATION



THIS MANUAL SHOULD BE RETAINED FOR FUTURE REFERENCE



 **CAUTION:** These models are designed, built, and sold for commercial use. If these models are positioned so the general public can use the equipment make sure that cautions, warnings, and operating instructions are clearly posted near each unit so that anyone using the equipment will use it correctly and not injure themselves or harm the equipment. 



 **WARNING:** Check the data plate on this unit before installation. Connect the unit only to the voltage and frequency listed on the data plate. Connect only to 1 or 3 phase as listed on the data plate. 



 **WARNING:** Disconnect device from electrical power supply and place a Tag Out-Lockout on the power plug, indicating that you are working on the circuit. 



 **WARNING:** Install per the spacing requirements listed in the installation section of this manual. We strongly recommend having a competent professional install the equipment. A licensed electrician should make the electrical connections and connect power to the unit. Local codes should always be used when connecting these units to electrical power. In the absence of local codes, use the latest version of the National Electrical Code. 



 **WARNING:** This device should be safely and adequately grounded in accordance with local codes, or in the absence of local codes, with the National Electrical code, ANSI/NFPA 70, Latest Edition to protect the user from electrical shock. It requires a grounded system and a dedicated circuit, protected by a fuse or circuit breaker of proper size and rating. Canadian installation must comply with the Canadian Electrical Code, CSAC22.2, as applicable. 



 **WARNING:** A factory authorized agent should handle all maintenance and repair. Before doing any maintenance or repair, contact the BevLes Company. 

 **WARNING:** Never clean any electrical unit by immersing it in water. Turn off before cleaning surface. 

 **WARNING:** An earthing cable must connect the appliance to all other units in the complete installation and from there to an independent earth connection. 

 **WARNING: SHOCK HAZARD** - De-energize all power to equipment before cleaning the equipment. 

 **CAUTION:** Suitable for installation on combustible floor when installed with legs or casters provided. 

 **WARNING: SHOCK HAZARD** - Do not open any panels that require the use of tools. 

Thank you for purchasing the Bevies Tender Touch Classic Oven. Tender Touch Ovens operate with a slow roasting and holding system designed to give you the most from your food products. By using a low temperature to cook, natural juices are retained, providing a more succulent, tender and tasteful product with greater yield. With minimum care, the easy-to-use Tender Touch Oven will provide you with years and years of dependable service.

About This Manual

This manual is designed to use with Bevies' Tender Touch Classic Oven. The first section explains the features and components of the oven. The second gives a step-by-step course on how to use its primary features. *Reading these two parts will provide you with enough information to use the oven for basic operation.* The third section is an in-depth explanation of each oven feature and a handy temperature guide for roasting and holding.

TABLE OF CONTENTS

Section 1		Section 4	
Features & Components	4-5	Wiring Diagram	8
Section 2		Section 5	
Getting Started	5	Parts List & Exploded Views	9
Section 3		Section 6	
Reference Guide	6	Warranty	15
Recommended Temperatures	6		
Cleaning	6		
Reassembly	7		

SECTION 1 FEATURES & COMPONENTS

Before getting started, please take a few minutes to become familiar with the various components and controls of your oven. We will go into much greater detail about their operation and use in the next section.

The Control Panel

The Control Panel is divided into three sections: The Instruction Area, the Operation Area and the Oven Status/Alert Area.

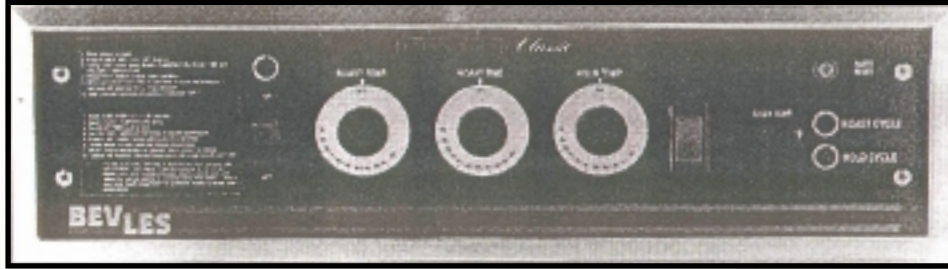

I. The Instruction Area

This area is located on the far left side of the panel. Listed are simple, easy-to-use steps for operating the roast-and-hold features or using the oven as a heated holding cabinet.



II. Operation Area

The second section, located at the center of the control panel, is the Operation Area. This is where the oven is controlled. The Operation Area consists of: the on/off power switch; the power indicator lamp; three knobs for controlling the operation of the oven; the "start" switch.

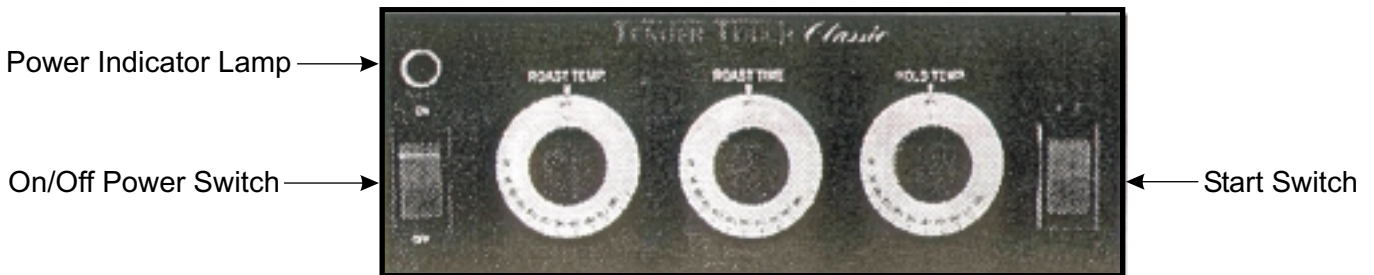

III. Oven Status/Alert Area

The third section of the control panel is the Oven Status/Alert Area at the far right. This area will show: the operating temperature of the oven; whether the oven is in the roast or hold cycle; if there has been a power failure during the roasting and/or holding cycle(s) that lasted longer than 3 minutes.

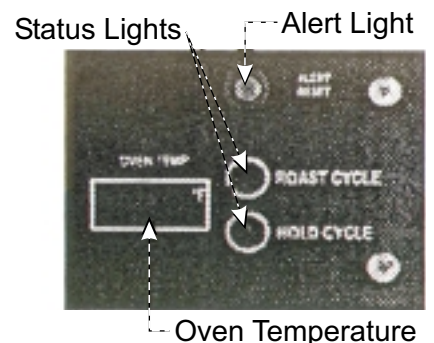

The Water Pan (Optional)

The Water Pan is an optional feature on the Classic, designed to provide additional humidity in the oven environment. Exposure to 140°F + temperatures for long periods of time will eventually dry the product. The water will add humidity to the air in the oven, thus helping to retard this drying process.

There are two parts to the water pan system:

The first is the pan itself. It's made of stainless steel and is completely removable to provide easy access for filling or cleaning in any type of sink.

The second part is composed of a stainless steel baffle system which (Provides optional humidity levels. Exposing more water surface creates greater levels of humidity).

SECTION 2 GETTING STARTED

In this section you will learn to use your new Tender Touch Classic Oven. We will go through a step-by-step course on how to set your oven to prepare food.

Before we start, you'll need to do a few things:

- Make sure that you have read and followed the unpacking and installation instructions, and that the oven is properly connected to the correct power source. Tender Touch Classic Ovens purchased as 120V models are provided with 8-foot cord and plug sets. All 208 - 240V models are only provided with an 8-foot cord. A qualified electrician or equipment installer should determine the proper plug for your facility.
- If you have the water pan option and wish to use it, make sure that the water pan and baffle are installed in the oven and that the tray is 3/4 full of water and pushed snugly to the back of the oven.
- Turn the power switch to the on position.
- Adjust the "ROAST TEMP" control to your desired roasting temperature (up to a maximum of 245°F).
- Use the middle control knob to select your desired roasting time.
- Set the last knob to the desired holding temperature (minimum 145°F).
- Allow the unit to preheat to the desired temperature approximately 20-30 minutes.
- Load oven with food product.
- Finally, make sure that the oven door is closed and securely latched.
- Press the "START" switch to begin the roasting process.

Note: You should always try to allow the product to remain in the "HOLDING" cycle for a minimum of 1-1/2 - 2 hours. This permits certain enzymes in the product to cause a tenderizing process to occur, resulting in a more tender and flavorful product.

If using the water pan option, you will probably want to check the water level at the start of the "ROAST" cycle, the start of the "HOLD" cycle and during any prolonged holding cycle.

SECTION 3 REFERENCE

This portion of the manual is intended as a reference guide for each of the Tender Touch Classic Oven functions.

Oven Status/Alert Panel

The Oven Status/Alert Panel is located on the right side of the control panel. This panel contains the two status indicator lights.



Roast Cycle

Indicates that the oven is in the ROASTING cycle. The product is roasting for the amount of time selected, and at the desired roasting temperature.

Hold Cycle

Indicates that the oven is in the HOLDING cycle, food is being held at a user determined temperature (minimum 145° F) for serving at a later time. Prolonged holding will result in changes in product doneness.

Power Loss

This visual alert appears when power is restored after a power failure lasting 3 minutes or more. Statistically, if a power failure surpasses the 3 minute mark, there are substantially increased odds that it will be a lengthy power loss. The Power loss Alert display is invisible until a failure activates it. Pressing the ALERT RESET key will cancel the alert display, returning it to standby mode. Whenever the power loss alert is displayed, the oven operator must determine if the power failure has left the product in an unsafe condition and take appropriate action. Contact the local Health Department for assistance, guidelines or recommendations.

Quick Reference

Recommended Roasting Temperatures:

190° F - For products requiring an internal temperature of less than 155° F.
215° F - For products requiring an internal temperature of 155° F to 180° F.

Recommended Holding Temperatures:

Minimum 145° F . Please contact the local Health Department for current guidelines or requirements.

Internal Temperature Guide*

Beef	Rare	130° - 135° F	Pork	170° - 180° F		
	Medium Rare	135° - 140° F		Lamb	165° -180° F	
	Medium	140° - 150° F	Poultry		Parts	170° - 175° F
	Medium Well	150° - 155° F			Whole Birds	180° F
	Well	155° - 160° F				

*Guideline only. Adjust as necessary for personal preferences or to meet requirements recommended by the local Health Department.

Cleaning

NOTE: Never use steel wool or caustic cleaning compounds on your Bevi's Tender Touch Classic Oven.

Cleaning Steps:

1. Push power switch to the OFF position.
2. Disconnect power cord from power supply.

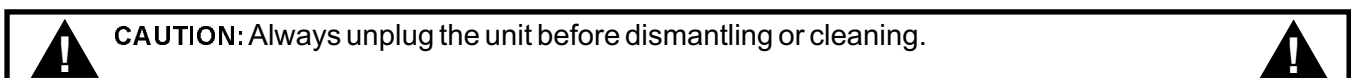

- Door(s) may be removed, if desired, by lifting entire door and sliding hinge off hinge pins. (Fig. 1 on this page)

NOTE: Avoid motions other than straight up or down when removing and replacing doors so as not to damage hinges.

- Slide out stainless steel water pan containing the baffle system (optional-not on all models).
- If desired, lift off the heating module from the top of the cabinet. (Fig. 2 on this page)
- Remove all pans and/or roasting racks.
- For universal models, remove the chrome wire pan supports on left and right airflow (side) panels.
- Remove airflow (side) panels by carefully lifting and tilting them toward the center of the cabinet. (Fig. 3 on this page)

NOTE: Handle the support panels carefully as damage or bending will make reinstallation extremely difficult.

- Models equipped with dutch doors will also have a removable wiper blade attached to the top of the bottom door. If desired, this may be removed by loosening the two black knobs at either end of the wiper blade retainer. Lift off the stainless steel retainer and the wiper blade.
- Clean all pieces thoroughly and carefully with soapy water and soft cloths.

NOTE - NEVER USE STEEL WOOL OR CAUSTIC CLEANING COMPOUNDS. CAUSTIC CHEMICALS MAY CAUSE DAMAGE TO INTERIOR SURFACES AND GASKETS.

CAUTION: Avoid splashing water or any other liquid on or into the heating module to prevent possible damage to electrical components.



Figure 1



Figure 2

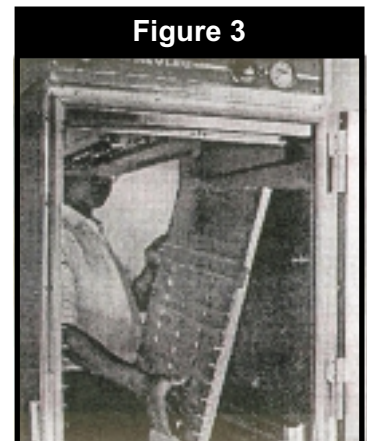

Figure 3

Reassembly Steps:

- Replace dutch door wiper blade if this was removed. Simply slide the gasket and retainer onto the top edge of the bottom door and re-tighten the two black knurled knobs.
- Carefully replace top mounted heating module.
- Replace air flow (side) panels.
- For universal models, replace the chrome wire pan supports.
- If removed, replace doors by sliding door hinges back down onto the hinge pins.
- You are now ready to operate your unit in accordance with the procedures outlined in section 3-2.

IMPORTANT FOR FUTURE REFERENCE

Please complete this information and retain this manual for the life of the equipment. For Warranty Service and/or Parts, this information is required.

_____ Model Number

_____ Serial Number

_____ Date Purchased

SECTION 4 WIRING DIAGRAM

WIRING DIAGRAM TENDER TOUCH CLASSIC

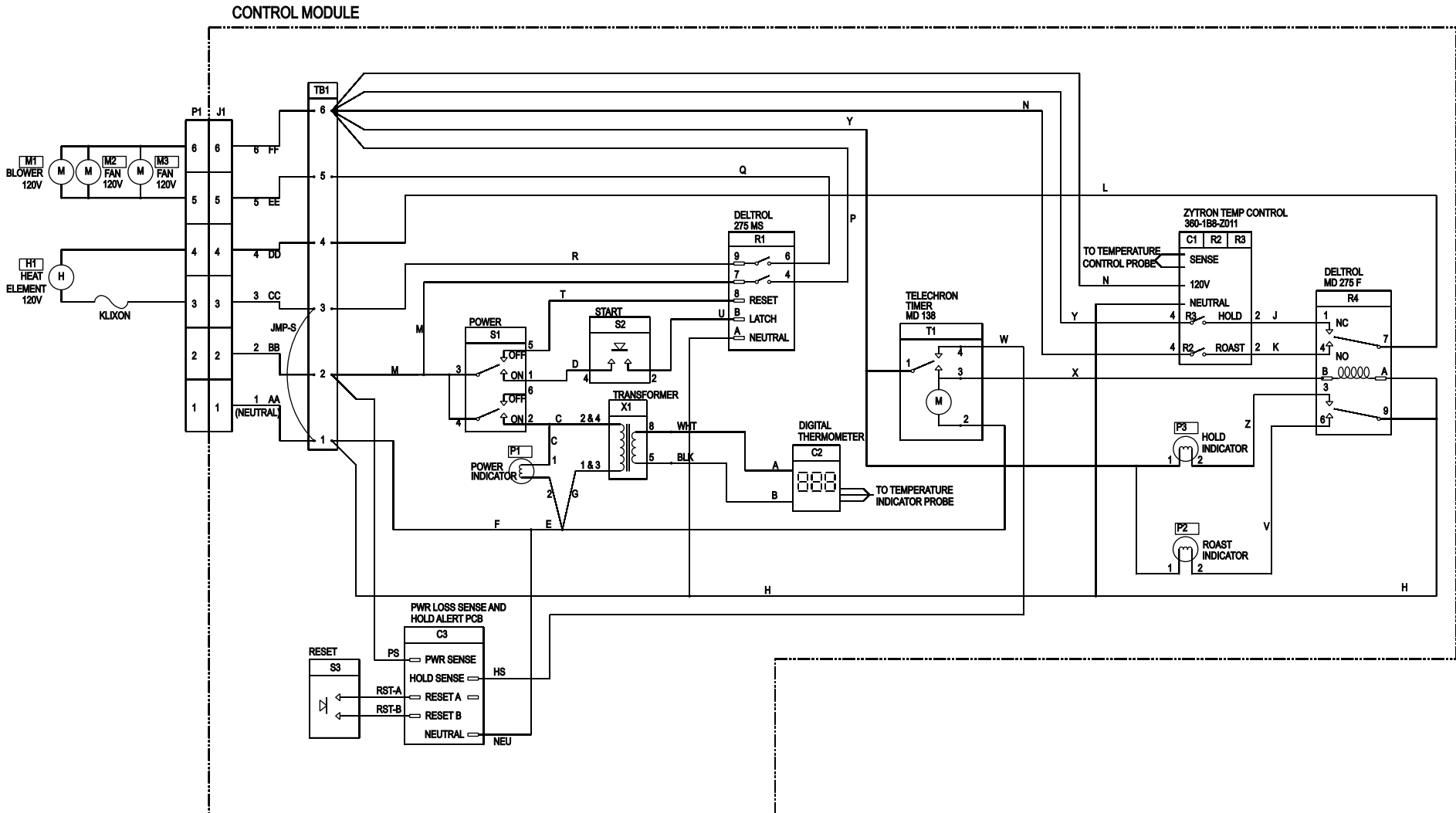

SECTION 5 PARTS LIST & EXPLODED VIEWS

EXPLODED VIEW (1 of 3) TENDER TOUCH CLASSIC

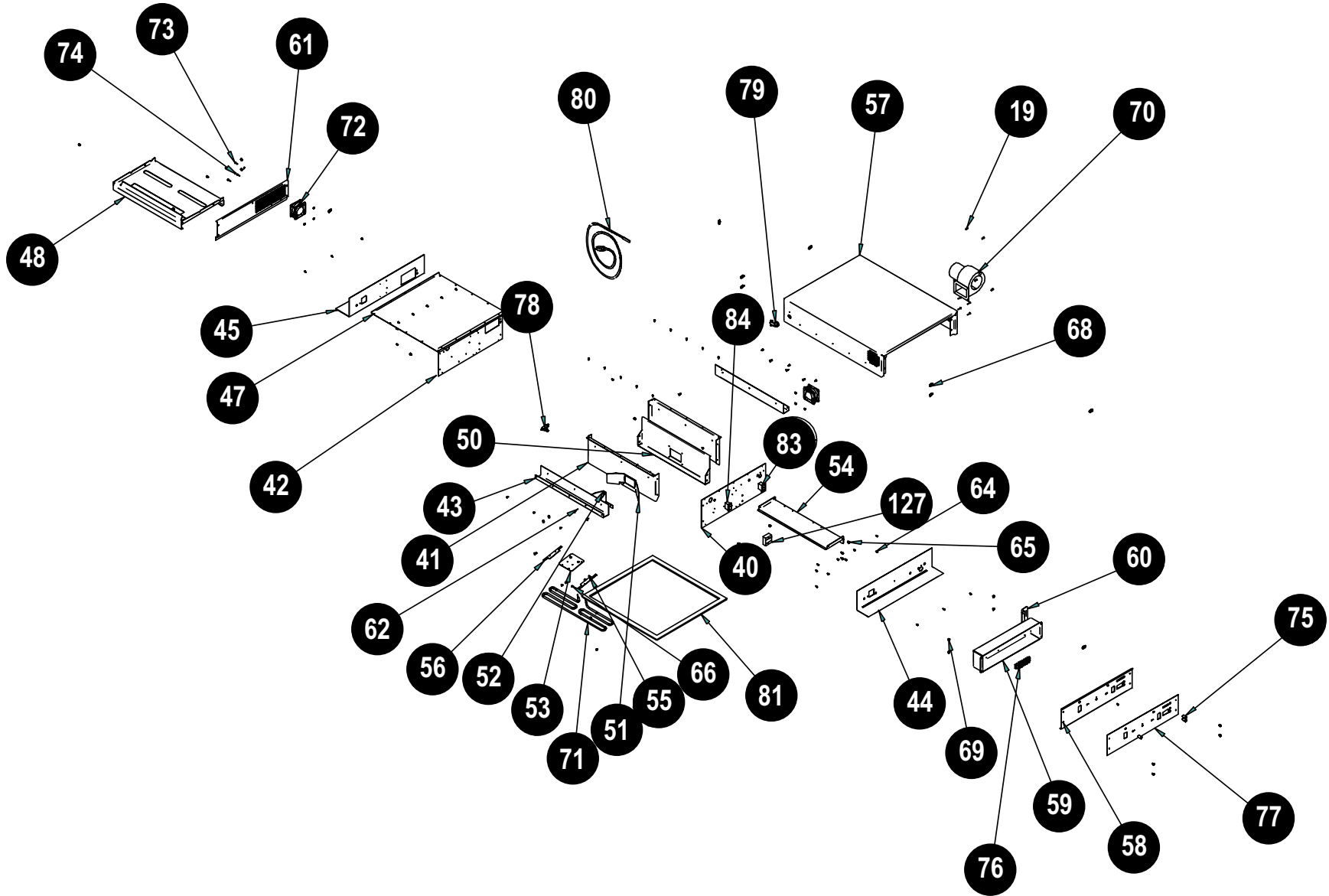

EXPLODED VIEW (2 of 3) TENDER TOUCH CLASSIC

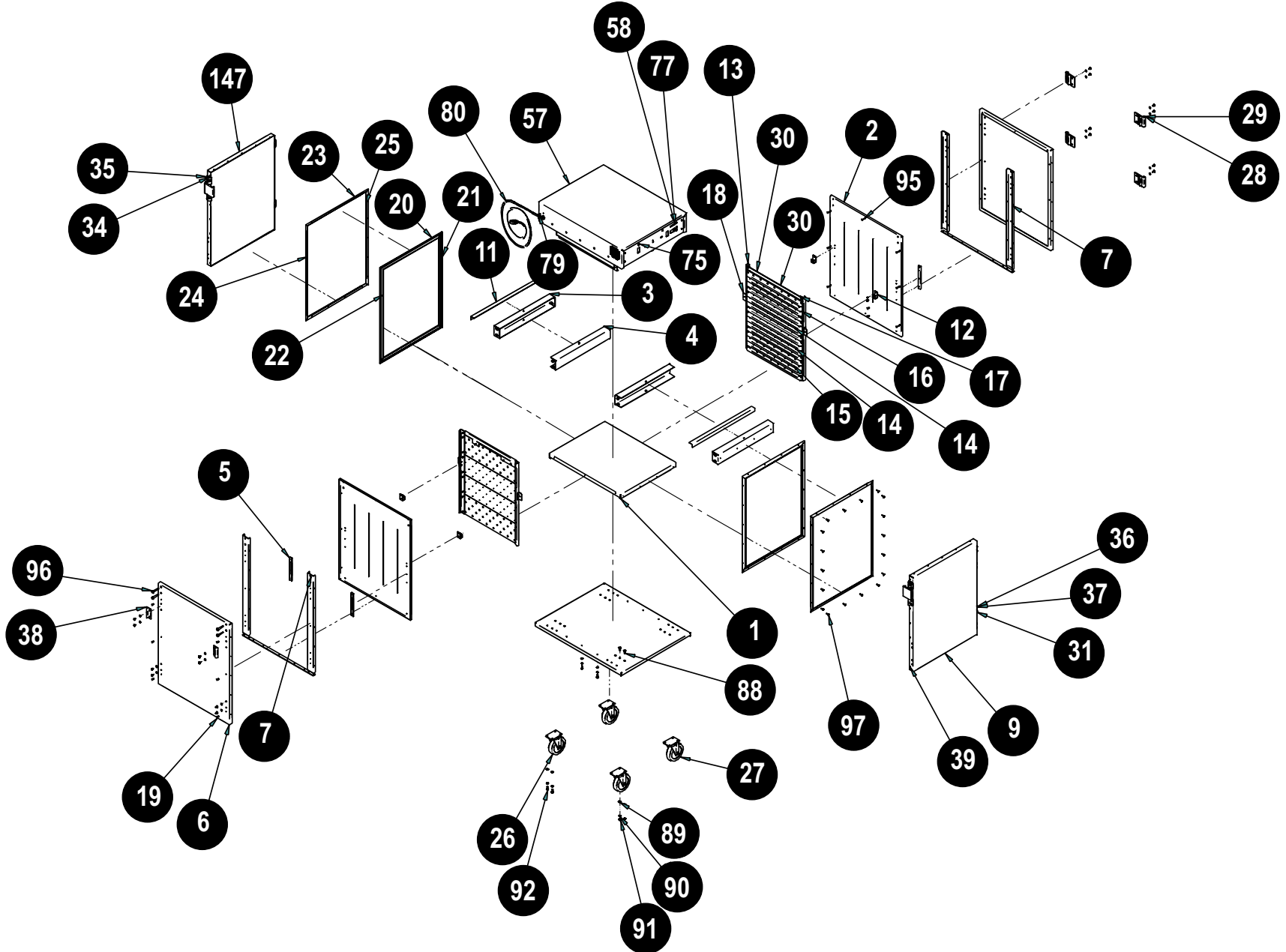

EXPLODED VIEW (3 of 3) TENDER TOUCH CLASSIC

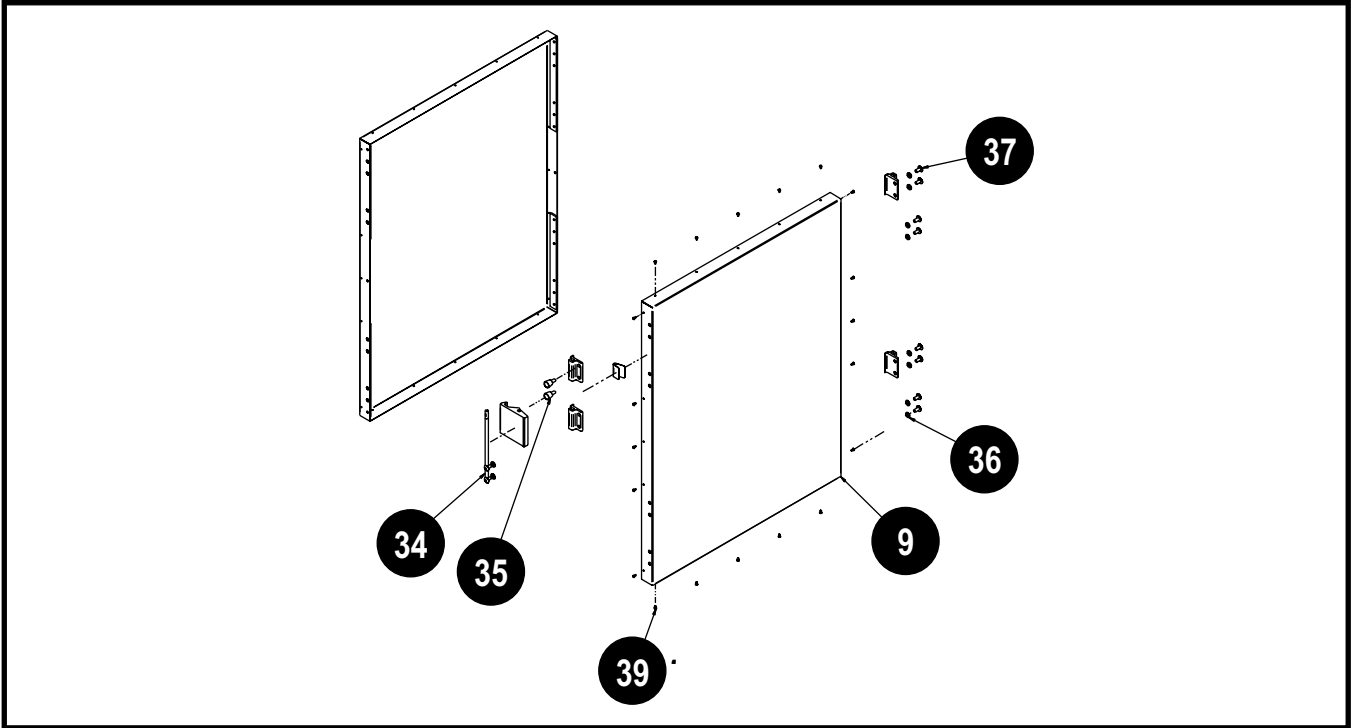

Item	P/N	Description	Quan	Item	P/N	Description	Quan
1	740893	Panel, Inner Base	1	*33	750419	Paddle Latch	2
2	740898	Panel, Inner Side	2	34	750716	Pin, Hinge	2
3	740972	Header Bar	2	35	783016	Knob, Thd Stud, 1/4-20 X .5	4
4	740908	Cover, Header Bar	2	36	8507900	Washer, Lock, Int, 1/4, Z	42
5	741450	Support, Button Side	4	37	8205500	Screw, 1/4-20 X 1/2 Tr Hd	36
6	740890	Panel, Outer Skin	2	38	750400	Latch Strike	2
7	740891	Support, Side, Hinge	4	39	8353000	Pop Rivet	40
*8	740900	Support, Base, Side	2	40	744346	Inner Skin, Front	1
9	740911	Door, Front Face	2	41	741100	Skin, Inner, Side, Top	2
*10	740899	Base, Outer	1	42	746588	Skin, Inner, Rear	1
11	745904	Cover, Header Bar	2	43	741084	Chanel, Side	2
12	740565	Bracket, Hook, Air Duct	4	44	740934	Channel, Front	1
13	740903	Upright, Air Duct	2	45	741298	Channel, Rear	1
14	751274	Panel, Air Duct	4	*46	744379	Air Duct Weldment	1
15	751303	Panel, Air Duct	2	47	746016	Divider, Insulation	1
16	751302	Panel, Air Dut	2	48	744334	Slides, Pan, Water	1
17	740902	Upright, Air Duct	2	*49	744535	Motor, Air Duct	1
18	745747	Bracket, Air Duct	4	50	744325	Motor Mounting	1
19	770000	Rivet, Soft, 1/2 Shiny, 390/lb	78	51	744332	Deflector, Fan, Section 2, CS42-HCUS6	1
20	740926	Gasket Retainer,inner, Top & Bottom	4	52	744333	Deflector, Fan, Section 1, CS42-HCUS6	1
21	740927	Gasket Retainer,inner, Right	2	53	744326	Access Cover, Heating Element	1
22	740930	Gasket Retainer,inner, Left	2	54	740831	Cover, Motor	1
23	740925	Retainer, Outer Gasket, Top & Bottom	4	55	784724	Ceramic Insulator	4
24	740929	Gasket Retainer, Outer, Right	2	56	743088	Clip, Heating Element	2
25	740931	Gasket Retainer, Outer,left	2	57	745553	Skin, Outer, Top 120V	1
26	780040	Caster 5" Hard Swivel	2	58	743709	Weldment, Front Panel	1
27	780036	Caster 5" Hard Swivel W/brake	2	59	743692	Enclosure, Electrical	1
28	750140	Hinge, Cabinet	4	60	741310	Guard, Connector, Control Panel	1
29	770720	Washer, Flat, AN960C156	6	61	743206	Panel, Rear	1
30	746137	Panel, Top Trim	2	62	8175900	Screw, 10-32 X 1/2 Tr Hd,SS	8
31	750132	Hinge, Butt	8	*63	743861	Cover, Heating Element	1
*32	781285	Latch Spring	2	64	8353400	Rivet, Pop 3/16 Flush Break	56

Item	P/N	Description	Quan	Item	P/N	Description	Quan
65	770536	Tr Hd Ph Sms 10 X 1/2 SS	19	*106	770320	Nutsert, #10-24 Aluminum	4
66	8400100	Nut, Hex Keps, #6-32	16	*107	770200	Nut Lock - Steel 3/4	2
*67	760288	Fiberglass Insulation	3	*108	751491	Pipe, Aluminum	1
68	770344	Nut, Tinnerman Clip	9	*109	770719	Washer, Lock, Int, #4, S/S	4
69	8408300	#8-32 Hex Nut, Keps, Ni	4	*110	770021	Nut, Hex, 4-40, S/S, Small Pat	4
70	784807	Blower, Motor, 1/2 Size, 120V	1	*111	770174	Screw, Machine Tr Hd Ph #10-24 X 3/4 SS	2
71	782098	Calrod Element 2000W, 120V	1	*112	8423700	Hex Nut 10-32 Keps	2
72	784680	Fan, Axial	2	*113	787035	Knob, Classic Roast & Hold	2
73	8110100	M/s Tr Hd Ph 6-32x3/4"	8	*114	787031	Knob, Classic Timer 0-16hrs	1
74	8500900	Washer, Flat, #6, SS	2	*115	781206	Wire Set TT/Classic Base 208-2	1
75	782116	Light, Indicator, 125V	3	*116	1501700	Tie, Cable, 4"	3
76	782144	Terminal Block	1	*117	8967200	Bushing, Snap .5 Hole Nylon	2
77	781030	Decal, Front	1	*118	783010	Wire Adhesive Back 1"	4
78	782208	Thermostat	1	*119	783007	Wire Hldr Adhesive Back	3
79	1101500	Box Connector, 90°	1	*120	784052	Wire Nut, Orange	2
80	782068	Cordset 12-3 Sjtow 5-20P	1	*121	783006	Connector, Wire Gray 16/22	8
81	784236	Gasket 20.875 X 24.125 Mp12	1	*122	770099	Standoff Threaded #6-32 Al	4
*82	720647	Inner Door	2	*123	784548	Mounting Adapter Conn- Red	2
83	784409	Switch, Single Pole Momentary	1	*124	782161	Relay, DPDT 120vac Deltrol	1
84	784410	Switch, DPDT	1	*125	782164	Relay, DPDT Magnetic Latch	1
*85	8169700	10-32 X 3/8 Lg. Screw	16	*126	784448	Transformer (120/240V)	1
*86	791146	Tie, Cable, 8.50 Nylon	2	127	784883	Thermometer-digital	1
*87	8980400	Clamp 1/4" Nylon	3	*128	784658	Sensor, Thermistor, 36" TFE Lead	1
88	770064	Bolt, Carriage 5/16-18x.75 Z	8	*129	784653	Controller, Temperature Dual Channel	1
89	8509300	Washer, Flat, Sae, 5/16	24	*130	782337	Powerloss Circuit Board	1
90	770037	Washer, Lock, Int, 5/16	24	*131	784411	Power Switch Leads; Short Body	1
91	8436200	Nut, Hex 5/16-18 S/S	16	*132	784651	Timer, 16 Hr TCC	1
92	8226500	Screw, Hex Cap 5/16-18 X 3/4, S/S	8	*133	784112	Duct Wrap 27 X 29 X 1.5	5
*93	8507600	Washer, Flat 1/4"	6	*134	781204	Foam Insert	4
*94	8211100	Screw, Mach 1/4-20 X 3/4	6	*135	784200	Urethane, 20.5x23x1.75	1
95	770461	Rivet, Ø3/16x15/16, .625-.750 Gr	14	*136	784512	Wire Shelf W/ Legs	2
96	770260	Carriage Bolt 5/16-18 X 2 Zn	8	*137	783180	Gasket, Mag, 20.75x28.00	2
97	8144000	T/s Tr Hd Ph Ta#8-32x3/4 S/S	36	*138	790008	Bag, Poly, 1.5 Mil, 62 X 84	1
*98	784716	Clamp, Cable, Ø.125	1	*139	790009	Pouch, Packing List	1
*99	784684	Cord 36" - Axial Fan	2	*140	780092	Manual, Tender Touch	1
*100	784496	Terminal, Fork	1	*141	780093	Cookbook, Tender Touch	1
*101	784493	Terminal, Ring, #10	1	*142	2910300	Carton, HSC 33 X 27 X 46	1
*102	784060	Wire Set	1	*143	792000	Lable, Packing Ins.	1
*103	783184	Spacer- Round Nylon	8	*144	2910500	Skid, 33 X 27	1
*104	783026	Wire Nut, Yel	4	*145	781193	Insulation, Front & Rear	2
*105	781205	Flex Connector 3/8 Regal 671	2	*146	781192	Insulation, Side	2
*NOT SHOWN							



6. BEVLES COMPANY LIMITED WARRANTY

729 Third Avenue * Dallas, TX 75226
Phone: +1 (214) 421-7366 Fax: +1 (214) 565-0976

1. Bevles warrants to the original purchaser that on the date the equipment is shipped (sold), it will be free of defects in materials or workmanship. Bevles will, at its discretion, repair or replace, during the warranty period printed below, any part that has a defect in material or workmanship that was present when the product shipped from Bevles, and which manifests itself during the warranty period under normal use and service.
 - Parts: Two* years from date of original shipment from the Bevles factory.
 - Labor: One** year from date of original shipment from the Bevles factory.

* Air Circulation Blower Assemblies (motors) and Power Switches shall be one year from date of original shipment.

Calrod "Air" Heating Elements shall be three years from date of original shipment.

** All electrical components 120 days from date of original shipment.
2. Bevles must be contacted, and pre-approval must be issued by the Bevles factory prior to any type of service being performed. Bevles assumes no responsibility for any charges that were not expressly authorized by the Bevles factory, or for any charges that exceed, in Bevles' sole judgement, normal and customary amounts.
3. Bevles will pay UPS Ground charges for any part that has a defect in material or workmanship that was present when the product shipped from Bevles, and which manifests itself during the **first year** of the warranty period under normal use and service. All warranty replacement parts will ship F.O.B. Bevles factory, Cheyenne, WY 82007.
4. This warranty shall be void in its entirety if any abuse of, misuse of, alteration/modification of or improper maintenance of original product occurs. If, at any time a claim is reported to Bevles, and the purchaser is delinquent in payment for the product, warranty will not apply.
5. Buyer's Remedies-If a Bevles product fails due to a defect in material or workmanship in conformity with the warranties in paragraph one, buyer shall notify Bevles of such failure within a reasonable time, but in no event beyond fifteen (15) days of such discovery of defect in material or workmanship. Bevles shall provide, in its sole discretion, either the repair or replacement of any defective or any non-conforming part. Bevles specifically disavows any other representation, warranty or liability relating to the continued use of the product.
6. Exclusion of consequential and incidental damages-In no event shall Bevles be liable for any incidental, special, indirect, or consequential damages, whether resulting from non-delivery or from the use, misuse, or inability to use the product, or from defects in the product, or from Bevles' own negligence or other tort. This exclusion applies regardless of whether such damages are sought for breach of warranty, breach of contract, negligence, or strict liability in tort or under any other legal theory.
7. Disclaimer of warranties-The warranties contained in paragraph one above are the exclusive warranties given by Bevles and supersede any prior, contrary, or additional representations, whether oral or written. Bevles hereby disclaims and excludes all other warranties-whether expressed, implied, or statutory-including any warranty of merchantability, any warranty of fitness for a particular purpose, and any implied warranties otherwise arising from course of dealing or usage of trade.

1/05



Phone: (214) 421-7366
Fax: (214) 565-0976
Toll Free: (800) 527-2100
Website: www.apwwyott.com
E-mail: info@apwwyott.com

BEVLES COMPANY, INC.
P.O. Box 1829
Cheyenne, WY 82003