



BUNN[®]
Quality Since 1840

My Café[®] MCR



INSTALLATION & OPERATING GUIDE

BUNN-O-MATIC CORPORATION

POST OFFICE BOX 3227

SPRINGFIELD, ILLINOIS 62708-3227

PHONE: (217) 529-6601 FAX: (217) 529-6644

To ensure you have the latest revision of the Operating Manual, or to view the Illustrated Parts Catalog, Programming Manual, or Service Manual, please visit the Bunn-O-Matic website, at www.bunn.com. This is absolutely FREE, and the quickest way to obtain the latest catalog and manual updates. For Technical Service, contact Bunn-O-Matic Corporation at 1-800-286-6070.



BUNN-O-MATIC COMMERCIAL PRODUCT WARRANTY

Bunn-O-Matic Corp. ("BUNN") warrants equipment manufactured by it as follows:

- 1) Airpots, thermal carafes, decanters, GPR servers, iced tea/coffee dispensers, MCR/MCP/MCA single cup brewers, thermal servers and ThermoFresh® servers (mechanical and digital) 1 year parts and 1 year labor.
- 2) All other equipment - 2 years parts and 1 year labor plus added warranties as specified below:
 - a) Electronic circuit and/or control boards - parts and labor for 3 years.
 - b) Compressors on refrigeration equipment - 5 years parts and 1 year labor.
 - c) Grinding burrs on coffee grinding equipment to grind coffee to meet original factory screen sieve analysis - parts and labor for 4 years or 40,000 pounds of coffee, whichever comes first.

These warranty periods run from the date of installation BUNN warrants that the equipment manufactured by it will be commercially free of defects in material and workmanship existing at the time of manufacture and appearing within the applicable warranty period. This warranty does not apply to any equipment, component or part that was not manufactured by BUNN or that, in BUNN's judgment, has been affected by misuse, neglect, alteration, improper installation or operation, improper maintenance or repair, non periodic cleaning and descaling, equipment failures related to poor water quality, damage or casualty. In addition, the warranty does not apply to replacement of items subject to normal use including but not limited to user replaceable parts such as seals and gaskets. This warranty is conditioned on the Buyer 1) giving BUNN prompt notice of any claim to be made under this warranty by telephone at (217) 529-6601 or by writing to Post Office Box 3227, Springfield, Illinois 62708-3227; 2) if requested by BUNN, shipping the defective equipment prepaid to an authorized BUNN service location; and 3) receiving prior authorization from BUNN that the defective equipment is under warranty.

THE FOREGOING WARRANTY IS EXCLUSIVE AND IS IN LIEU OF ANY OTHER WARRANTY, WRITTEN OR ORAL, EXPRESS OR IMPLIED, INCLUDING, BUT NOT LIMITED TO, ANY IMPLIED WARRANTY OF EITHER MERCHANTABILITY OR FITNESS FOR A PARTICULAR PURPOSE. The agents, dealers or employees of BUNN are not authorized to make modifications to this warranty or to make additional warranties that are binding on BUNN. Accordingly, statements by such individuals, whether oral or written, do not constitute warranties and should not be relied upon.

If BUNN determines in its sole discretion that the equipment does not conform to the warranty, BUNN, at its exclusive option while the equipment is under warranty, shall either 1) provide at no charge replacement parts and/or labor (during the applicable parts and labor warranty periods specified above) to repair the defective components, provided that this repair is done by a BUNN Authorized Service Representative; or 2) shall replace the equipment or refund the purchase price for the equipment.

THE BUYER'S REMEDY AGAINST BUNN FOR THE BREACH OF ANY OBLIGATION ARISING OUT OF THE SALE OF THIS EQUIPMENT, WHETHER DERIVED FROM WARRANTY OR OTHERWISE, SHALL BE LIMITED, AT BUNN'S SOLE OPTION AS SPECIFIED HEREIN, TO REPAIR, REPLACEMENT OR REFUND.

In no event shall BUNN be liable for any other damage or loss, including, but not limited to, lost profits, lost sales, loss of use of equipment, claims of Buyer's customers, cost of capital, cost of down time, cost of substitute equipment, facilities or services, or any other special, incidental or consequential damages.

392, A Partner You Can Count On, Air Infusion, AutoPOD, AXIOM, BrewLOGIC, BrewMETER, Brew Better Not Bitter, BrewWISE, BrewWIZARD, BUNN Espresso, BUNN Family Gourmet, BUNN Gourmet, BUNN Pour-O-Matic, BUNN, BUNN with the stylized red line, BUNNlink, Bunn-O-Matic, Bunn-O-Matic, BUNNserve, BUNNSERVE with the stylized wrench design, Cool Froth, DBC, Dr. Brew stylized Dr. design, Dual, Easy Pour, EasyClear, EasyGard, FlavorGard, Gourmet Ice, Gourmet Juice, High Intensity, iMIX, Infusion Series, Intellisteam, My Café, Phase Brew, PowerLogic, Quality Beverage Equipment Worldwide, Respect Earth, Respect Earth with the stylized leaf and coffee cherry design, Safety-Fresh, savemycoffee.com, Scale-Pro, Silver Series, Single, Smart Funnel, Smart Hopper, SmartWAVE, Soft Heat, SplashGard, The Mark of Quality in Beverage Equipment Worldwide, ThermoFresh, Titan, trifacta, TRIFECTA (stylized logo), Velocity Brew, Air Brew, Beverage Bar Creator, Beverage Profit Calculator, Brew better, not bitter., Build-A-Drink, BUNNSource, Coffee At Its Best, Cyclonic Heating System, Daypart, Digital Brewer Control, Element, Milk Texturing Fusion, Nothing Brews Like a BUNN, Picture Prompted Cleaning, Pouring Profits, Signature Series, Sure Tamp, Tea At Its Best, The Horizontal Red Line, Ultra are either trademarks or registered trademarks of Bunn-O-Matic Corporation. The commercial trifacta® brewer housing configuration is a trademark of Bunn-O-Matic Corporation.

CONTENTS

Warranty	2
Introduction	3
User Notices	3
CE/North America Requirements	4
Electrical Requirements	5
Plumbing Requirements	6
Initial Setup.....	7
Brewing.....	8
Cleaning.....	9
Tank Draining.....	10
Programming.....	11

INTRODUCTION

This equipment is factory set to brew approximately 6-8 ounces of coffee or tea into an awaiting dispenser. It is only for indoor use on a sturdy counter or shelf. Replace any unreadable or damaged labels.

USER NOTICES



#00986.0002

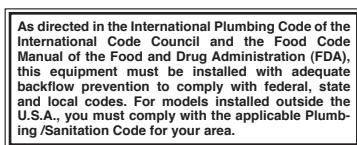

#00656.0001



#49343.0001



#37280.0001



#00824.0002



#37881.0002

NORTH AMERICAN REQUIREMENTS

- This appliance must be installed in locations where it can be overseen by trained personnel.
- For proper operation, this appliance must be installed where the temperature is between 41°F to 95°F (5°C to 35°C).
- Appliance shall not be tilted more than 10° for safe operation.
- An electrician must provide electrical service as specified in conformance with all local and national codes.
- This appliance must not be cleaned by pressure washer.
- This appliance can be used by persons aged from 18 years and above if they have been given supervision or instruction concerning use of the appliance in a safe way and if they understand the hazards involved.
- Keep the appliance and its cord out of reach of children aged less than 18 years.
- Appliances can be used by persons 18 years and above with reduced physical, sensory or mental capabilities or lack of experience and knowledge if they have been given supervision or instruction concerning use of the appliance in a safe way and understand the hazards involved.
- Children under the age of 18 years should be supervised to ensure they do not play with the appliance.
- If the power cord is ever damaged, it must be replaced by the manufacturer or authorized service personnel with a special cord available from the manufacturer or its authorized service personnel in order to avoid a hazard.
- Machine must not be immersed for cleaning.
- Cleaning and user maintenance shall not be made by children unless they are older than 18 years and supervised.
- This appliance is intended for commercial use in applications such as:
 - staff kitchen areas in shops, offices and other working environments;
 - by clients in hotel and motel lobbies and other similar types of environments;
- Access to the service areas permitted by Authorized Service personnel only.

ELECTRICAL REQUIREMENTS

CAUTION - The brewer must be disconnected from the power source until specified in *Initial Set-Up*.

Refer to Data Plate on the Brewer, and local/national electrical codes to determine circuit requirements.



120 VOLT Model

Note: This electrical service consists of 2 current carrying conductors (L1 and Neutral) and a separate conductor for chassis ground.

Electrical Hook-Up

CAUTION – Improper electrical installation will damage electronic components.

1. An electrician must provide electrical service as specified.
2. Using a voltmeter, check the voltage and color coding of each conductor at the electrical source.
3. If plumbing is to be hooked up later be sure the brewer is disconnected from the power source. If plumbing has been hooked up, the brewer is ready for Initial Set-Up.

PLUMBING REQUIREMENTS

These brewers must be connected to a cold water system with operating pressure between 20 and 90 psi (0.138 and 0.620 MPa) from a ½" or larger supply line. A shut-off valve should be installed in the line before the brewer. Install a regulator in the line when pressure is greater than 90 psi (0.620 MPa) to reduce it to 50 psi (0.345 MPa). The water inlet fitting is .75-11.5 NH (HOSE THREAD). For convenience an elbow adaptor is provided to convert to a ¼" flare fitting. Bunn-O-Matic does not recommend the use of a reverse-osmosis or deionized water supply to this equipment.

NOTE - Bunn-O-Matic recommends ¼" copper tubing for installations of less than 25 feet and ¾" for more than 25 feet from the ½" water supply line. A tight coil of tubing in the water line will facilitate moving the brewer to clean the countertop. Bunn-O-Matic does not recommend the use of a saddle valve to install the brewer. The size and shape of the hole made in the supply line by this type of device may restrict water flow.

As directed in the International Plumbing Code of the International Code Council and the Food Code Manual of the Food and Drug Administration (FDA), this equipment must be installed with adequate backflow prevention to comply with federal, state and local codes. For models installed outside the U.S.A., you must comply with the applicable Plumbing /Sanitation Code for your area.

NOTE - If a backflow preventer is required by code, a shock arrestor should be installed between backflow preventer and dispenser. Installing the shock arrestor as close to the dispenser as possible will provide the best results.

Plumbing Hook-Up

1. Flush the water line.
2. Securely attach the adaptor elbow assembly to the ¼" flare fitting on water supply line.
3. Securely attach adaptor elbow assembly to the the .75-11.5 NH fitting at the rear of the brewer.
4. Turn on the water supply.

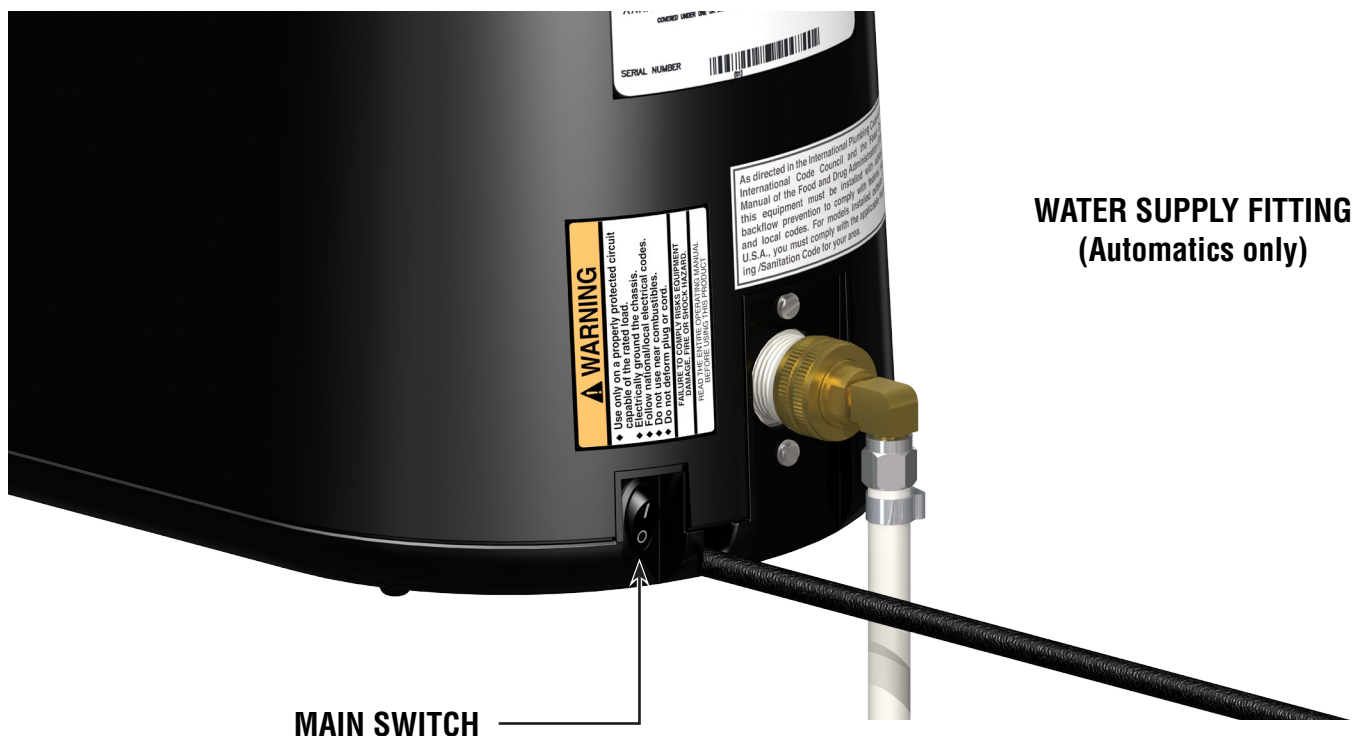

INITIAL SET-UP

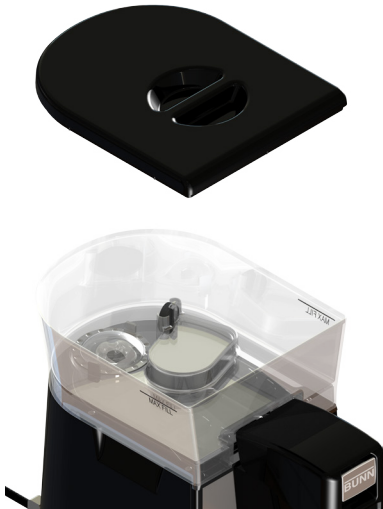

POUROVERS ONLY: REMOVE TOP COVER

Wash out reservoir with mild detergent and rinse with clean water before filling. Pour in water to the max fill line.



CONNECT TO POWER SOURCE

Turn on main power switch. Water will flow from reservoir to fill the internal tank. Wait approximately ten minutes for the water to heat. The "READY" indicator will remain "red" until tank reaches it's operating temperature, then turn green.



PLACE CUP

Place a large empty cup (10 oz. or more) under the brew chamber.

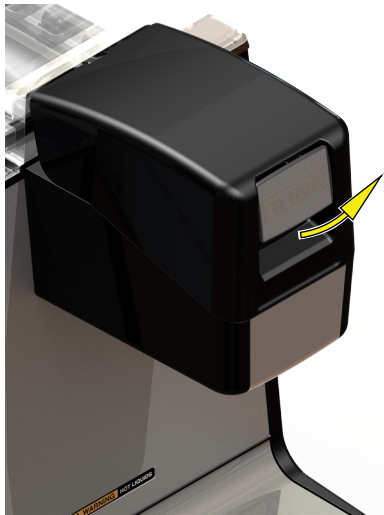

OPEN & CLOSE CHAMBER

Pull bottom or push top of handle to open. When heated (green light), open, then close brew chamber.

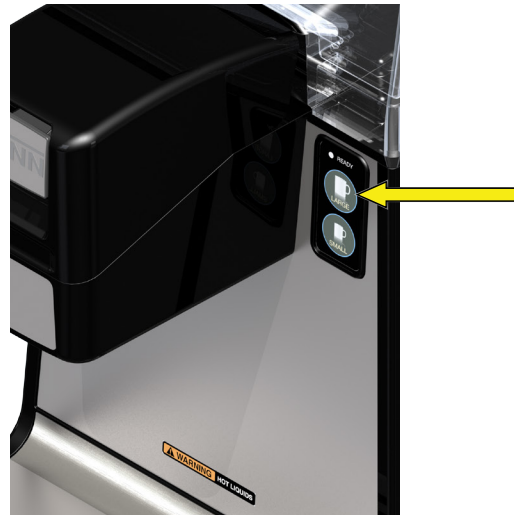

PRESS LARGE BREW BUTTON

Water will flow into the cup. When finished, discard contents of cup.

Water volumes and flow settings have been preset at the factory. Refer to "ADJUSTMENTS" section of this manual for the "SET BREW VOLUMES", should the volume need to be increased or decreased.

The brewer is now ready for use in accordance with the instructions for Coffee Brewing.

BREWING

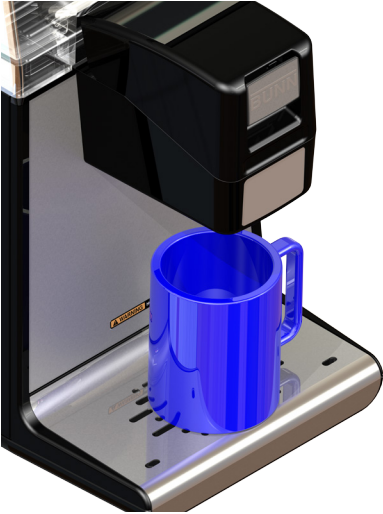

PLACE CUP

Place empty cup under the brew chamber.

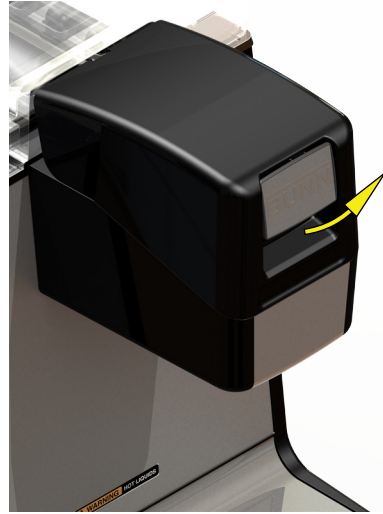

OPEN BREW CHAMBER

Pull bottom or push top of handle to open.

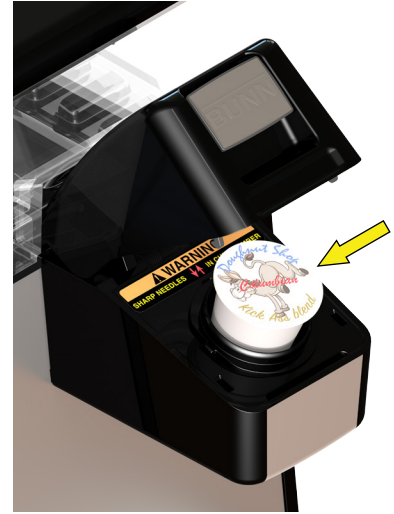

INSERT CUP

Push lid down to close brew chamber.



REMOVE TOP COVER

Pour in water up to fill line.
(POUR IN MODELS ONLY)



START

Press the desired brew button.
Once the brew cycle is finished,
remove cup.

LARGE BREW

SMALL BREW

NOTE

Light will change from green
to alternating red/green during
brew cycle.

CLEANING

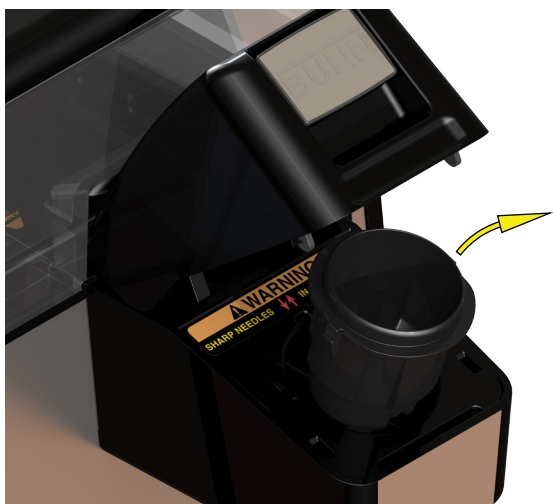

CUP HOLDER

1. Disconnect brewer from power source and allow to cool.
2. Open the cup holder.
3. Remove cup holder by squeezing it to one side and lifting out.
4. Wash and rinse cup holder. Verify holes are cleared. **CAUTION: CUP CONTAINS A SHARP NEEDLE.**
5. Wipe off rubber seal under cup holder.
6. Install cup holder back into housing.

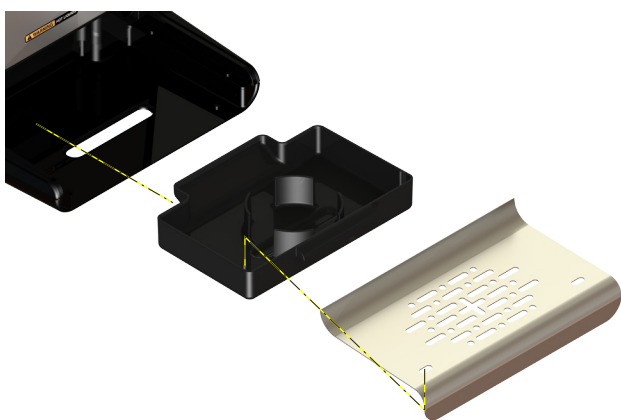

DRIPTRAY

1. Lift the drip tray cover straight up.
2. Pull the drip tray out and clean as needed.



SCREEN

1. Disconnect brewer from power source.
2. Remove reservoir cover.
3. Pull screen assembly up by either of the two tabs.
4. Wash and rinse as needed. Push back down until rubber ring is flush with reservoir bottom.
5. Install reservoir cover.



SPRAYHEAD CLEANING

1. Disconnect brewer from power source.
2. **Allow brewer to cool before proceeding!**
3. Open the cup holder.
4. Insert cleaning tool into the sprayhead (upper needle). Verify the hole is free of debris.

The use of a damp cloth rinsed in any mild, nonabrasive, liquid detergent is recommended for cleaning all surfaces on Bunn-O-Matic equipment.

TANK DRAINING

TANK DRAINING

1. Disconnect the power and water supply to brewer.
Allow brewer to cool before proceeding.
2. Remove the top cover.
3. Lift reservoir up and set aside.



4. Remove 5 screws securing rear cover.
5. Remove cover.

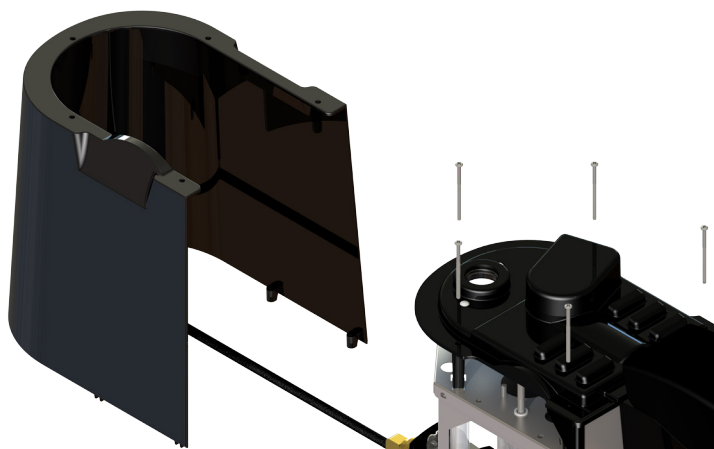

6. Place brewer next to a sink.
7. Remove small tube from left side of tank lid.
8. Insert a syphon tube or hose through the grommet hole to syphon water out of tank.



PROGRAMMING

Setting the Large and Small Brew volume:

1. Press and hold the Large (to adjust Large brew) or Small brew switch (to adjust Small) for 5 seconds **while the brew chamber is open**. During that time the red/green LEDs will flash rapidly. After 5 seconds the LEDs will turn off.

The large batch switch will increase the volume and the small batch switch will decrease the volume.

2. If setting the large batch, each time the large or small switch is pressed, the red LED will momentarily flash.
3. If setting the small batch, each time the large or small switch is pressed the green LED will momentarily flash.
4. Each time the switch is pressed, the volume is increased or decreased by .25 Ounces.

If the maximum volume (16.0) or the minimum volume (4.0) is reached, the red LED will flash rapidly for the large volume. The green LED will flash rapidly for the small volume. **DEFAULTS: 8oz/6oz**

If no switches are depressed for 10 seconds -- the setup mode is exited

Changing the temperature set point between high altitude (190° F) and low altitude (200° F) (default = 200° F):

1. Press the Large brew switch 5 times (within 5 seconds) with the brew chamber open. This will cause the temperature to toggle modes. If the New temperature is 190° F, the red LED will flash 5 times. If the New temperature is 200 degrees, the red LED will flash 10 times.

Enabling or Disabling the Energy save mode:

Press the Small brew switch 5 times (within 5 seconds) with the brew chamber open. This will cause the energy save to toggle modes. If the new mode is energy save enabled, the green LED will flash 5 times. If the new mode is energy save disabled, the green LED will flash 10 times.

Energy Save Enabled: After 6 hours of inactivity, temperature drops to 140° F. After 26 hours, tank heater turns off.

Energy Save Disabled: Tank temperature remains at 200° F (or 190° F if set to high altitude).

Restoring the factory defaults:

1. Turn off the main power switch.
2. Press and hold both Large and Small batch Switches and turn on power switch. Continue pressing both switches for 5 seconds.
3. After 5 seconds, the red and green LEDs will flash rapidly for 5 seconds, the operator must release and press both the Large and Small Batch switches within 5 seconds. The red and green LEDs will turn off for approximately 5 seconds and then turn on and off 5 times indicating success.

FAULT CODES

# of Flashes	Fault Code	Description
1	Refill too long	Check water supply. Verify reservoir is full. Cycle power to reset code.
2	Water pump fault	Check for clogged cup holder or sprayhead (see page 8). Cycle power to reset code.
3	Pressure sensor out of range	Check for clogged cup holder or sprayhead (see page 8). Cycle power to reset code.
4	Dump valve or float fault	Check that float is installed and moves freely in reservoir. Check/clear reservoir screen (see page 8). Cycle power to reset code.
5	No flow counts during brew	Check water level in reservoir. Check/clean reservoir screen. Check/verify reservoir is fully seated. Cycle power to reset code.
6	Heating too long	Heating Circuit Failure. See service manual for diagnostics.
7	Temp sensor open	Check connections at CBA. Replace as required. See service manual.
8	Temp sensor short	Check connections at CBA. Replace as required. See service manual.
9	Float stuck fault	Check that float moves freely in guide & that float does float with water in reservoir. Cycle power to reset code.