

BUNN®

BrewWISE®
DBC® BREWERS
WITH SMART FUNNEL®

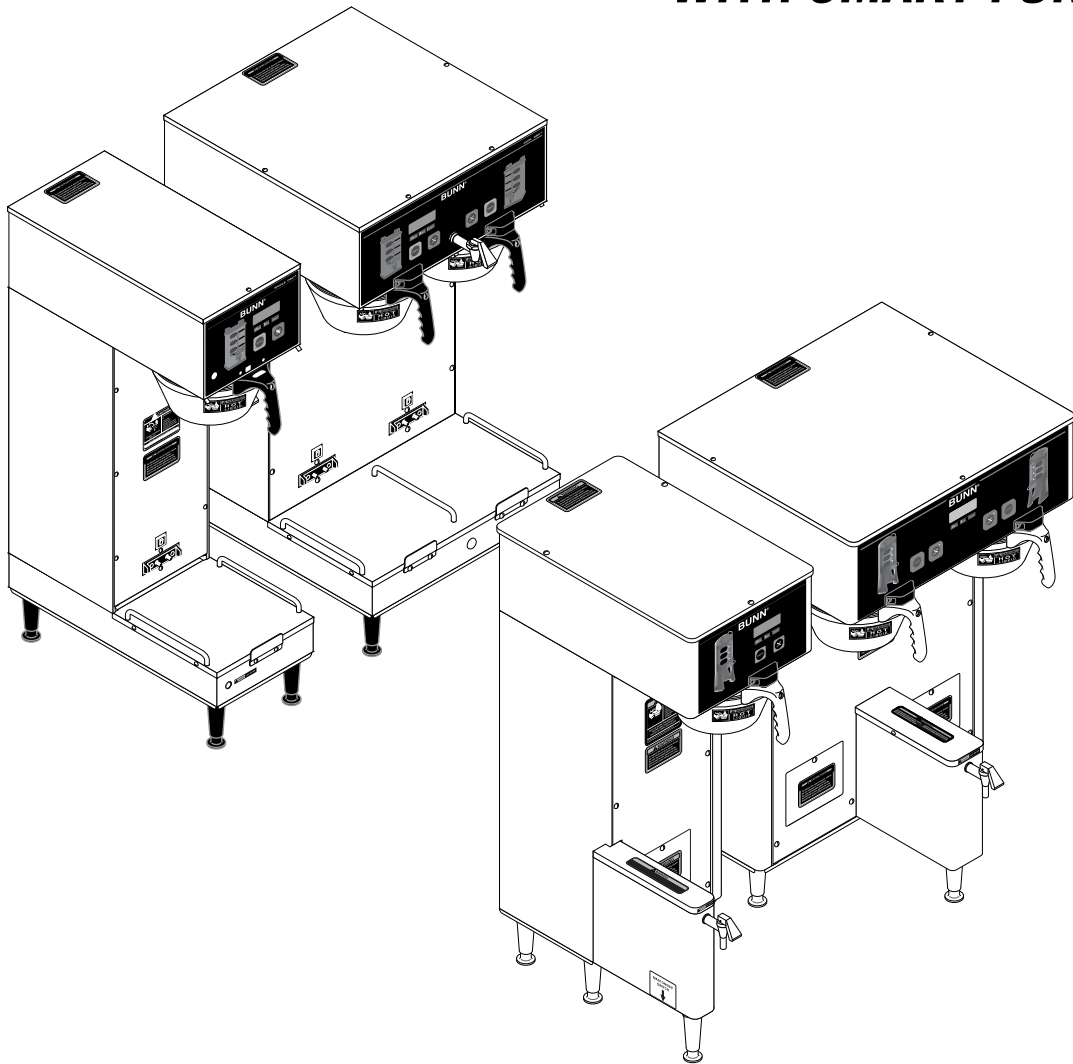

SERVICE & REPAIR MANUAL

BUNN-O-MATIC CORPORATION

POST OFFICE BOX 3227

SPRINGFIELD, ILLINOIS 62708-3227

PHONE: (217) 529-6601 FAX: (217) 529-6644

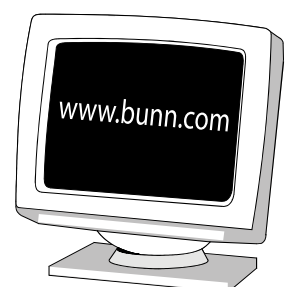

BUNN-O-MATIC COMMERCIAL PRODUCT WARRANTY

Bunn-O-Matic Corp. ("BUNN") warrants equipment manufactured by it as follows:

- 1) Airpots, thermal carafes, decanters, GPR servers, iced tea/coffee dispensers, MCP/MCA pod brewers thermal servers and Thermofresh servers (mechanical and digital)- 1 year parts and 1 year labor.
- 2) All other equipment - 2 years parts and 1 year labor plus added warranties as specified below:
 - a) Electronic circuit and/or control boards - parts and labor for 3 years.
 - b) Compressors on refrigeration equipment - 5 years parts and 1 year labor.
 - c) Grinding burrs on coffee grinding equipment to grind coffee to meet original factory screen sieve analysis - parts and labor for 4 years or 40,000 pounds of coffee, whichever comes first.

These warranty periods run from the date of installation BUNN warrants that the equipment manufactured by it will be commercially free of defects in material and workmanship existing at the time of manufacture and appearing within the applicable warranty period. This warranty does not apply to any equipment, component or part that was not manufactured by BUNN or that, in BUNN's judgment, has been affected by misuse, neglect, alteration, improper installation or operation, improper maintenance or repair, non periodic cleaning and descaling, equipment failures related to poor water quality, damage or casualty. In addition, the warranty does not apply to replacement of items subject to normal use including but not limited to user replaceable parts such as seals and gaskets. This warranty is conditioned on the Buyer 1) giving BUNN prompt notice of any claim to be made under this warranty by telephone at (217) 529-6601 or by writing to Post Office Box 3227, Springfield, Illinois 62708-3227; 2) if requested by BUNN, shipping the defective equipment prepaid to an authorized BUNN service location; and 3) receiving prior authorization from BUNN that the defective equipment is under warranty.

THE FOREGOING WARRANTY IS EXCLUSIVE AND IS IN LIEU OF ANY OTHER WARRANTY, WRITTEN OR ORAL, EXPRESS OR IMPLIED, INCLUDING, BUT NOT LIMITED TO, ANY IMPLIED WARRANTY OF EITHER MERCHANTABILITY OR FITNESS FOR A PARTICULAR PURPOSE. The agents, dealers or employees of BUNN are not authorized to make modifications to this warranty or to make additional warranties that are binding on BUNN. Accordingly, statements by such individuals, whether oral or written, do not constitute warranties and should not be relied upon.

If BUNN determines in its sole discretion that the equipment does not conform to the warranty, BUNN, at its exclusive option while the equipment is under warranty, shall either 1) provide at no charge replacement parts and/or labor (during the applicable parts and labor warranty periods specified above) to repair the defective components, provided that this repair is done by a BUNN Authorized Service Representative; or 2) shall replace the equipment or refund the purchase price for the equipment.

THE BUYER'S REMEDY AGAINST BUNN FOR THE BREACH OF ANY OBLIGATION ARISING OUT OF THE SALE OF THIS EQUIPMENT, WHETHER DERIVED FROM WARRANTY OR OTHERWISE, SHALL BE LIMITED, AT BUNN'S SOLE OPTION AS SPECIFIED HEREIN, TO REPAIR, REPLACEMENT OR REFUND.

In no event shall BUNN be liable for any other damage or loss, including, but not limited to, lost profits, lost sales, loss of use of equipment, claims of Buyer's customers, cost of capital, cost of down time, cost of substitute equipment, facilities or services, or any other special, incidental or consequential damages.

392, AutoPOD, AXIOM, BrewLOGIC, BrewMETER, Brew Better Not Bitter, BrewWISE, BrewWIZARD, BUNN Espresso, BUNN Family Gourmet, BUNN Gourmet, BUNN Pour-O-Matic, BUNN, BUNN with the stylized red line, BUNNlink, Bunn-OMatic, Bunn-O-Matic, BUNNserve, BUNNSERVE with the stylized wrench design, Cool Froth, DBC, Dr. Brew stylized Dr. design, Dual, Easy Pour, EasyClear, EasyGard, FlavorGard, Gourmet Ice, Gourmet Juice, High Intensity, iMIX, Infusion Series, Intellisteam, My Café, Phase Brew, PowerLogic, Quality Beverage Equipment Worldwide, Respect Earth, Respect Earth with the stylized leaf and coffee cherry design, Safety-Fresh, savemycoffee.com, Scale-Pro, Silver Series, Single, Smart Funnel, Smart Hopper, SmartWAVE, Soft Heat, SplashGard, The Mark of Quality in Beverage Equipment Worldwide, ThermoFresh, Titan, trifecta, Velocity Brew, A Partner You Can Count On, Air Brew, Air Infusion, Beverage Bar Creator, Beverage Profit Calculator, Brew better, not bitter., BUNNSource, Coffee At Its Best, Cyclonic Heating System, Daypart, Digital Brewer Control, Nothing Brews Like a BUNN, Pouring Profits, Signature Series, Tea At Its Best, The Horizontal Red Line, Ultra are either trademarks or registered trademarks of Bunn-O-Matic Corporation.

TABLE OF CONTENTS

Warranty	2
Table of Contents	3
Troubleshooting	4
Service Tools.....	15
Component Access	19
Control Board	19
Membrane Switch.....	20
Dispense and Bypass Valves.....	21
Refill Valves	22
Tank Heaters	24
Temperature Probe	25
Limit Thermostats	25
Warmer Elements	26
Master Power Switch.....	26
SH Server Timer	27
Schematic (Wiring Diagram).....	28



TROUBLESHOOTING

A troubleshooting guide is provided to suggest probable causes and remedies for the most likely problems encountered. If the problem remains after exhausting the troubleshooting steps, contact the Bunn-O-Matic Technical Service Department.

- Inspection, testing, and repair of electrical equipment should be performed only by qualified service personnel.
- All electronic components have 120 - 240 volt ac and low voltage dc potential on their terminals. Shorting of terminals or the application of external voltages may result in board failure.
- Intermittent operation of electronic circuit boards is unlikely. Board failure will normally be permanent. If an intermittent condition is encountered, the cause will likely be a switch contact or a loose connection at a terminal or crimp.
- Solenoid removal requires interrupting the water supply to the valve. Damage may result if solenoids are energized for more than ten minutes without a supply of water.
- The use of two wrenches is recommended whenever plumbing fittings are tightened or loosened. This will help avoid twists and kinks in the tubing.
- Make certain that all plumbing connections are sealed and electrical connections tight and isolated.
- This brewer is heated at all times. Keep away from combustibles.

WARNING

- Exercise extreme caution when servicing electrical equipment.
- Disconnect the brewer from the power source when servicing, except when electrical tests are specified.
- Follow recommended service procedures.
- Replace all protective shields or safety notices.

Screen Displayed	Possible Cause	Troubleshooting Procedures
	1. Overflow cup is full of water. This could be caused by boiling. Refer to <i>SET TEMP</i> and <i>REFILL</i> sections in Programming Manual.	Empty cup. Correct cause and retry.
 (SH Models only)	1. Soft Heat Server not correctly positioned on base. 2. Not using a Soft Heat Server, and the SERVER DETECT function is activated (on).	Position the server so that the connector pins on the server make contact with connector on the brewer. Disable the SERVER DETECT function.

TROUBLESHOOTING (cont.)

Screen Displayed

←←← NO FUNNEL
PRESENT

Possible Cause

1. **SMART FUNNEL** not fully inserted into the funnel rails.
2. Not using a **SMART FUNNEL**, and the **FUNNEL DETECT** function is activated (on).

Troubleshooting Procedures

Position the funnel so that the sensor is directly beneath the sensor coil on the brewer.

Disable the **FUNNEL DETECT** function.

TEMPERATURE
TOO LOW

1. Water temperature in the tank does not meet the **SET READY TEMPERATURE**.

(a) Wait for the brewer to heat to the proper temperature.

(b) Disable the **BREW LOCKOUT** function.

←← CHECK FUNNEL
FOR FRESH COFFEE

1. Brew funnel was not removed after the previous brew cycle was finished.

Remove funnel, check contents, and insert back into the funnel rails.

OR

PRESS BREW
TO BREW ANYWAY

Press **BREW** to start a brew cycle without removing the funnel.

BREW STOPPED!
FUNNEL REMOVED?

1. Brew funnel was moved out of position after the brew cycle was started.

To resume brewing, correctly position the funnel and press **BREW** again. The brew cycle will resume from the point it was interrupted.

OR

TO FINISH:
PRESS BREW

Press **ON/OFF** to terminate the cycle.

TO CANCEL
PRESS ON/OFF

TROUBLESHOOTING (cont.)

Screen Displayed

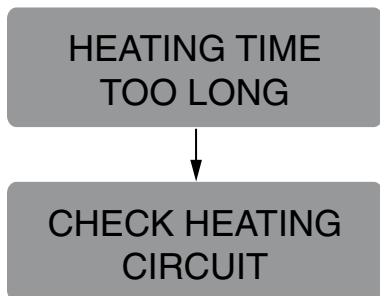
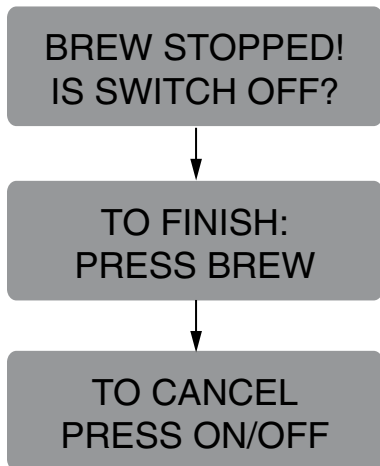
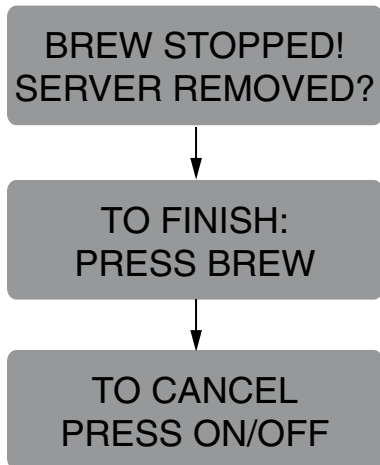

Possible Cause

1. Soft Heat Server was moved out of position after the brew cycle was started.

1. **ON/OFF** switch was pressed after the brew cycle was started.

1. Tank Heater failure

2. Triac Failure

3. Control Board/Thermistor failure

Troubleshooting Procedures

To resume brewing, correctly position the Soft Heat Server and press **BREW** again. The brew cycle resumes from the point it was interrupted.

OR

Press **ON/OFF** to terminate the brew cycle.

To resume brewing, press **BREW** again. The brew cycle resumes from the point it was interrupted.

OR

Press **ON/OFF** to terminate the brew cycle.

Service Required. See *TANK HEATERS*.

Service Required. See

Service Required. See *CONTROL BOARD*

TROUBLESHOOTING (cont.)

Screen Displayed

FILL TIME TOO LONG



CHECK WATER SUPPLY

Possible Cause

1. Water shut off to brewer
2. Inlet Solenoid Valve failure
3. Control Board Failure

Troubleshooting Procedures

Check water supply shut-off

Service required. See *REFILL VALVE*.

Service required. See *CONTROL BOARD*.

TEMP SENSOR OUT OF RANGE



CHECK FOR BAD CONNECTIONS

1. Temperature Sensor Probe wire(s) broken or not making connection.

Check wire and connection of both black and white wires of temperature probe.

TEMP SENSOR OUT OF RANGE



CHECK WIRE FOR SHORTS

1. Temperature Sensor Probe wire(s) shorted to housing, or to each other.

Check to confirm that wire(s) are not pinched between two surfaces or connected to each other.

TROUBLESHOOTING (cont.)

Problem	Possible Cause	Troubleshooting Procedure
Equipment will not operate.	1. No power or incorrect voltage.	Measure the voltage at the terminal block and confirm that it matches the voltage specified on the brewer data plate within +/- 10%.
Brew cycle will not start.	1. No water	Check plumbing and shut-off valves
	2. ON/OFF switch	Test the ON/OFF switch. Refer to the switch test procedures in <i>SERVICE TOOLS</i> section.
	3. Brew switch	Test the BREW switch. Refer to the switch test procedures in <i>SERVICE TOOLS</i> section.
	4. Brew Valve	Test the Brew valve. Refer to <i>Testing Individual Components</i> in <i>SERVICE TOOLS</i> section.
	5. Electronic Control Board	Substitute a control board known to be in good working order.
Automatic refill will not operate or display shows FILL TIME TOO LONG	1. No water	Check plumbing and shut-off valves.
	2. Water strainer/flow control (.750 GPM)	(A) Direction of flow arrow must be pointing towards direction of water flow. (B) Remove the strainer/flow control and check for obstructions. Clear or replace.

TROUBLESHOOTING (cont.)

Problem	Possible Cause	Troubleshooting Procedure
Automatic refill will not operate or display shows FILL TIME TOO LONG (cont.)	3. Refill Probe or Sensitivity Setting	Check the sensitivity setting. Refer to <i>Refill</i> function. If the left three digit number is less than the right number, the machine “thinks” it is full and the refill valve should be off. If the left number is larger than the right, then the refill valve will automatically be turned on to fill the tank. The right number is the threshold setting and can be adjusted to compensate for extreme water conditions: very pure, low conductance water requires a higher setting, while high mineral content, high conductance water requires a lower setting. Note that the left number changes from a high value when water is NOT touching the refill probe to a low value when water IS touching the probe. For best operation, the right number should be set to a value midway between these low and high numbers. Before changing the setting, confirm that the refill probe is free of scale buildup and the connection to it is secure.
	4. Refill Valve	Test the Refill valve. Refer to <i>Testing Individual Components</i> .
	5. Overflow Protection Switch	When this condition occurs, the brewer will display OVERFLOW CUP FULL. EMPTY CUP. The reason for overfilling could be a defective refill valve, an incorrect sensitivity setting, (see above) or boiling.
	6. Electronic Control Board	Substitute a control board known to be in good working order.
Water flows into tank continuously with power removed from brewer.	1. Refill valve	Foreign material lodged in valve, holding it in open state.

TROUBLESHOOTING (cont.)

Power

Possible Cause

Troubleshooting Procedures

Water flows into tank continuously with power applied to brewer.

1. Refill Probe or Sensitivity Setting

Check the sensitivity setting. Refer to *Refill* function. If the left three digit number is less than the right number, the machine “thinks” it is full and the refill valve should be off. If the left number is larger than the right, then the refill valve will automatically be turned on to fill the tank. The right number is the threshold setting and can be adjusted to compensate for extreme water conditions: very pure, low conductance water requires a higher setting, while high mineral content, high conductance water requires a lower setting. Note that the left number changes from a high value when water is NOT touching the refill probe to a low value when water IS touching the probe. For best operation, the right number should be set to a value midway between these low and high numbers. Before changing the setting, confirm that the refill probe is free of scale buildup and the connection to it is secure.

2. Electronic Control Board

Substitute a control board known to be in good working order.

Water will not heat or display shows HEATING TIME TOO LONG

1. Limit Thermostat

CAUTION - Do not eliminate or bypass limit thermostat. Use only replacement part #23717.0003.

Remove power from the brewer. Press reset button on limit thermostat. Then check for continuity through it.

2. Tank Heaters

Remove power from the brewer. Check for continuity through the tank heaters.

TROUBLESHOOTING (cont.)

Problem	Possible Cause	Troubleshooting Procedures
Water will not heat or display shows HEATING TIME TOO LONG (cont.)	3. Triac	Remove power from the brewer. Connect a voltmeter across one of the tank heaters. Reapply power to the brewer and refer to <i>Testing Individual Components</i> . If the full supply voltage is measured when the tank heater is turned on, and zero voltage is measured with the triac off, then the triac is good. If half the supply voltage is measured, the triac is defective. If very low, or zero voltage is measured, there could be a defective triac or a defective control board.
	4. Electronic Control Board	Perform the above procedure for testing triacs. If the voltage measured is very low or zero, then substitute a control board known to be in good working order.
Spitting or unusual steaming from sprayhead or air vents. (Water too hot)	1. Triac	Remove power from the brewer. Connect a voltmeter across one of the tank heaters. Reapply power to the brewer and refer to <i>Testing Individual Components</i> . If the full supply voltage is measured when the tank heater is turned on, and zero voltage is measured with the triac off, then the triac is good. If half the supply voltage is measured, the triac is defective. If very low, or zero voltage is measured, there could be a defective triac or a defective control board.
	2. Lime Buildup	CAUTION - Tank and tank components should be delimed regularly depending on local water conditions. Excessive mineral buildup on stainless steel surfaces can initiate corrosive reactions resulting in serious leaks.

TROUBLESHOOTING (cont.)

Problem	Possible Cause	Troubleshooting Procedures
Spitting or unusual steaming from sprayhead or air vents. (Water too hot) (cont.)	3. Electronic control board	Perform the previous procedure for testing triacs. If the voltage measured is very low or zero, then substitute a control board known to be in good working order.
Inconsistent beverage level in server.	1. Strainer/flow control (.750 GPM)	(A) Direction of flow arrow must be pointing towards the brewer. (B) Remove the strainer/flow control and check for obstructions. Clear or replace.
	2. Improper water pressure	Check operating water pressure to the brewer. It must be between 20 and 90 psi (138 and 620 kPa).
	3. Brew Valve	Test the Brew Valve. Refer to <i>Testing Individual Components</i> . Turn the valve on for 30 seconds and collect the water dispensed from the sprayhead. Repeat the test several times to confirm a consistent volume of dispensed water. If not consistent, check the valve, tubing and sprayhead for lime buildup.
	4. Bypass Valve	If bypass is being used on the inconsistent brewing recipe, test the Bypass Valve. Refer to <i>Testing Individual Components</i> . Turn the valve on for 30 seconds and collect the water collected from the bypass opening. Repeat the test several times to confirm a consistent volume of dispensed water. If not consistent, check the valve, tubing and bypass opening for lime buildup.
	5. Lime buildup	Inspect for lime buildup that could block the tank, tank fittings, tubing, valves and sprayhead.

TROUBLESHOOTING (cont.)

Problem	Possible Cause	Troubleshooting Procedures
Consistently high or low beverage level in server.	1. Brew Volume adjustment	Adjust the brew volume as required to achieve the recommended volume for each brew cycle.
Dripping from sprayhead.	1. Brew Valve	Repair or replace leaky valve.
Water overflows filter.	1. Type of paper filters	BUNN paper filters should be used for proper extraction.
	2. No sprayhead	Check sprayhead
Beverage overflows server.	1. Beverage left in server from previous brew	The brew cycle should be started only with an empty server under the funnel.
	2. Brew Volume adjustment	Adjust the brew volume as required to achieve the recommended volume for each brew cycle.
Weak beverage.	1. Type of paper filters	BUNN paper filters should be used for proper extraction.
	2. Coffee	A sufficient quantity of fresh drip or regular grind should be used for proper extraction.
	3. Sprayhead	The correct B.O.M. sprayhead should be used to properly wet the bed of ground coffee in the funnel.
	4. Funnel Loading	The BUNN paper filter should be centered in the funnel and the bed of ground coffee leveled by gentle shaking.
	5. Water temperature	Empty the server, remove its cover, and place the server beneath the sprayhead. Place empty funnel over the server entrance, with ON/OFF switch in the "ON" position press the start switch and release it. Check the water temperature immediately below the sprayhead with a thermometer. The reading should not be less than 195°F (91°C).

TROUBLESHOOTING (cont.)

Problem	Possible Cause	Troubleshooting Procedures
Weak beverage (cont.)	6. Incorrect Recipe	Consider adjusting bypass percentage, preinfusion, or pulse brew. Contact Bunn-O-Matic for suggestions.
Brewer is making unusual noises.	1. Solenoid (Inlet)	The nut on back of the solenoid must be tight or it will vibrate during operation
	2. Plumbing lines	Plumbing lines should not be resting on the counter top.
	3. Water Supply	(A) The brewer must be connected to a cold water line. (B) Water pressure to the brewer must not be higher than 90 psi (620 kPa). Install a regulator if necessary to lower the working pressure to approximately 50 psi (345 kPa).
	4. Tank Heaters.	Remove and clean lime off tank heaters.

TROUBLESHOOTING (cont.)

SERVICE TOOLS

This function allows the testing of individual components and the ability to check switches for proper function. This function also tests the Soft Heat server's status on the brewer (in place or removed), and the funnel sensor coil's frequency (diagnostic tool for troubleshooting purposes only).

Testing individual components (outputs):

This will allow the operator to test the operation of individual components and outputs of the brewer. The components that can be individually tested are as follows:

SINGLE Brewers

Brew Valve
Bypass Valve
Funnel Lock (Optional)
Server (SH models only)
Refill Valve
Tank Heaters
Heater Contactor

DUAL Brewers

Left Brew Valve
Left Bypass
Left Funnel Lock (Optional)
Left Server (SH models only)
Right Brew Valve
Right Bypass
Right Funnel Lock (Optional)
Right Server (SH models only)
Refill Valve
Tank Heaters
Heater Contactor

Procedure to test components (outputs):

1. Place brew funnel(s) into rails on the brewer (both sides on DUAL brewers).
2. Place server(s) beneath the brew funnel(s).
3. Press and hold the upper right hidden switch until display reads **UNITS**. Release the switch. Continue to press and release switch until **SERVICE TOOLS** appears.
4. Press **YES** to run tests on various components and outputs within the brewer. Pressing **NO** will exit this function and advance to next function screen.
5. The display should read **TEST OUTPUTS**.

6. Press and release **YES**. The display should read: **BREW VALVE** on SINGLE brewers
LEFT BREW VALVE on DUAL brewers.
7. To test **BREW VALVE**, press **ON**. If the brew valve is functional, water should run from the brewer (left side on DUAL brewers)
8. Press **OFF** to end flow of water.
9. Press **NEXT** to advance to the next component to be tested.

NOTE: To bypass testing any component, press **NEXT** to advance to the next one, without testing the previous component.

10. To test **BREW BYPASS** on SINGLE brewers or **LEFT BREW BYPASS** on DUAL brewers, press **ON**. If the bypass valve is functional, water should run from the brew bypass (left side on DUAL brewers).
11. Press **OFF** to end flow of water.
12. Press **NEXT** to advance to the next component to be tested.
13. To test **FUNNEL LOCK** on SINGLE brewers or **LEFT FUNNEL LOCK** on DUAL brewers, press **ON**. If the funnel lock is functional, the lock will come down to hold the funnel in place.
14. Press **OFF** to retract the funnel lock.
15. Press **NEXT** to advance to the next component to be tested.
16. (SH models only) To test **SERVER** on SINGLE brewers or **LEFT SERVER** on DUAL brewers, press **ON**. If the server and the sensor are functional, the light on the lower right corner of the server will illuminate.
17. Press **OFF** to end testing of server.
18. Press **NEXT** to advance to the next component to be tested.
19. For DUAL brewers, follow steps 7 through 16 to test the right side components.
20. To test **REFILL VALVE**, press **ON**. If the refill valve is functional, the sound of the valve operating will be heard.
21. Press **OFF** to end testing of refill valve.
22. Press **NEXT** to advance to the next component to be tested.
23. To test **TANK HEATERS**, connect a voltmeter across each of the tank heaters to check for voltage.
24. Press **ON**. The correct voltage should be present at the heater terminals.
25. Press **OFF** to end testing of the tank heaters.

TROUBLESHOOTING (cont.)

SERVICE TOOLS (cont.)

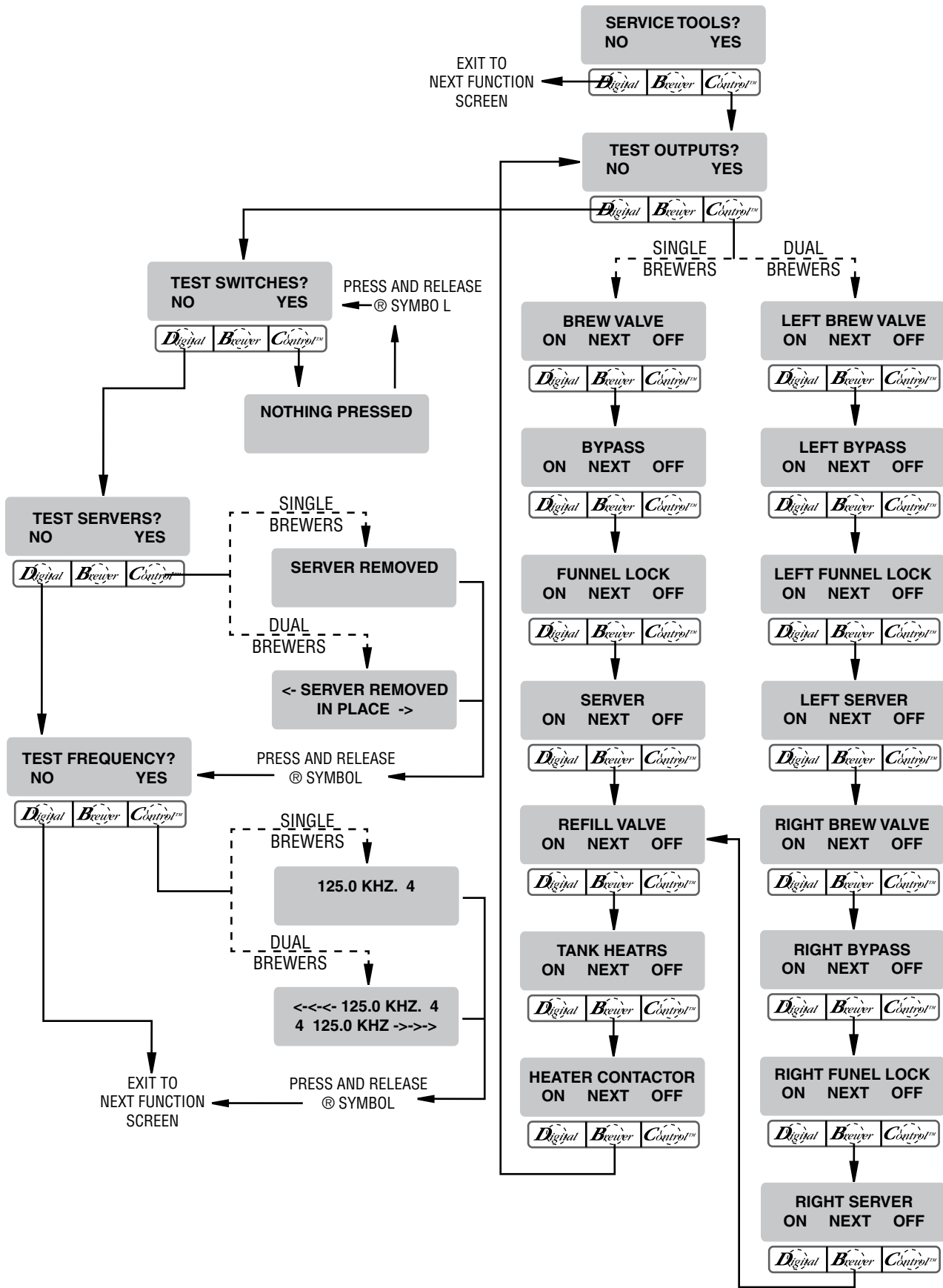

TROUBLESHOOTING (cont.)

SERVICE TOOLS (cont.)

NOTE: The tank heater will automatically turn off if left on too long.

26. After testing the tank heater, press **NEXT** to advance to the next test.
27. The **HEATER CONTACTOR** is used only on certain models. Check the machine schematic to see if the contactor is present. Connect a voltmeter across a tank heater that is operated by the contactor and press **ON** to check that correct voltage is present. Press **OFF** and confirm the voltage is zero.
28. Press **NEXT** to return to **TEST OUTPUTS**.
29. To exit **SERVICE TOOLS**, press and release the ON/OFF switch (either on DUAL brewers) located on the front switch panel. This will return to the **MAIN SCREEN**.

Procedure to test switches:

This function allows the operator to test the operation of the individual switches on the front panel.

1. Place brew funnel(s) into rails on the brewer (both sides on DUAL brewers).
2. Place server(s) beneath the brew funnel(s).
3. Press and hold the upper right hidden switch until display reads **UNITS**. Release the switch. Continue to press and release switch until **SERVICE TOOLS** appears.
4. Press **YES** to run tests on various components and outputs within the brewer. (Pressing **NO** will exit this function and advance to the next function screen.)
5. The display should read **TEST OUTPUTS**.
6. In **TEST OUTPUTS** screen, press **NO**. This advances to **TEST SWITCHES**.
7. Pressing **NO** in this screen will advance to the next function. Press **YES** in the **TEST SWITCHES** screen to test the switches. The display will read **NOTHING PRESSED**.
8. From this screen, press any of the switches on the front of the brewer except the upper right hidden switch. While the switch is pressed, the display shows the name of that switch. If the name does not appear, or if it remains after the switch has been released, the switch is defective. Each switch can be tested in this manner.
9. After all switches have been tested, press and release the right hidden switch (®). This will return

to **TEST SWITCHES?**. Press and release switch again to advance to **TEST SERVERS?**. Another alternative is to press and release the ON/OFF switch (either on DUAL brewers) located on the front switch panel. This will exit **TEST SWITCHES** and return to the **MAIN SCREEN**.

Procedures to test servers: (SH models only)

This function allows the operator to test the operation of the Soft Heat servers. It will also show if the server is correctly placed on the brewer stand.

1. Place brew funnel(s) into rails on the brewer (both sides on DUAL brewers).
2. Place a Soft Heat server(s) beneath the brew funnel(s).
3. Press and hold the upper right hidden switch until the display reads **UNITS**. Release the switch. Continue to press and release switch until **SERVICE TOOLS?** appears.
4. Pressing **NO** will exit this function and advance to the next function screen. Press **YES** to run tests on various components and outputs within the brewer.
5. The display should read **TEST OUTPUTS?**
6. In **TEST OUTPUTS** screen, press **NO**. This advances to **TEST SWITCHES?**. Press and release **NO** once more. The display should now read **TEST SERVER(S)?**
7. Press **YES** in the **TEST SERVER(S)** screen to show if a server is in place. The display should read **IN PLACE** (with arrows pointing to the left and right on DUAL brewers).
8. Lift and pull both Soft Heat servers forward about 2 inches so that the two contacts on each server do not touch the two contacts on the brewer.
9. The display should then read **SERVER REMOVED** (with arrows pointing to the left and right on DUAL brewers).
10. After the server(s) have been tested, press and release the ON/OFF switch (either on DUAL brewers) located on the front switch panel. This will exit **TEST SERVERS** and return to the **MAIN SCREEN**.

Procedures to test coil frequency:

1. Place brew funnel(s) into rails on the brewer (both sides on DUAL brewers).
2. Place server(s) beneath the brew funnel(s).

TROUBLESHOOTING (cont.)

SERVICE TOOLS (cont.)

3. Press and hold the upper right hidden switch until the display reads **UNITS**. Release the switch. Continue pressing and releasing the upper right hidden switch until **SERVICE TOOLS** appears.
4. Pressing **NO** will exit this function and advance to the next function screen. Press **YES** to run tests on various components and outputs within the brewer.
5. The display should read **TEST OUTPUTS?**.
6. In **TEST OUTPUTS** screen, press **NO**. Continue to press and release **NO** until the display reads **TEST FREQUENCY?**.
7. Press and release **YES**. The display will show the frequency of the sensor coil circuits. This is for diagnostic service use when troubleshooting this circuit.
8. After the coils have been tested, press and release the ON/OFF switch (either on DUAL brewers) located on the front switch panel. This will exit the **TEST FREQUENCY** function and return to the **MAIN SCREEN**.

NOTE: If the operator wishes to test more than one function in the **SERVICE TOOLS** section (outputs, switches, servers, or coil frequency), it is not necessary to exit the program. Use the flow chart for **SERVICE TOOLS** to navigate to a particular function.

COMPONENT ACCESS

This section provides procedures for testing and replacing various major components used in this brewer should service become necessary. Refer to Troubleshooting for assistance in determining the cause of any problem.

WARNING - Inspection, testing, and repair of electrical equipment should be performed only by qualified service personnel. The brewer should be disconnected from power source when servicing, except when electrical tests are required and the test procedure specifically states to plug in the brewer.

WARNING - Disconnect the brewer from the power source before the removal of any panel or the replacement of any component.

All components are accessible by the removal of the top cover, front access panel and platform cover.

Refer to wiring diagrams at the back of this manual when reconnecting wires.

CONTROL BOARD

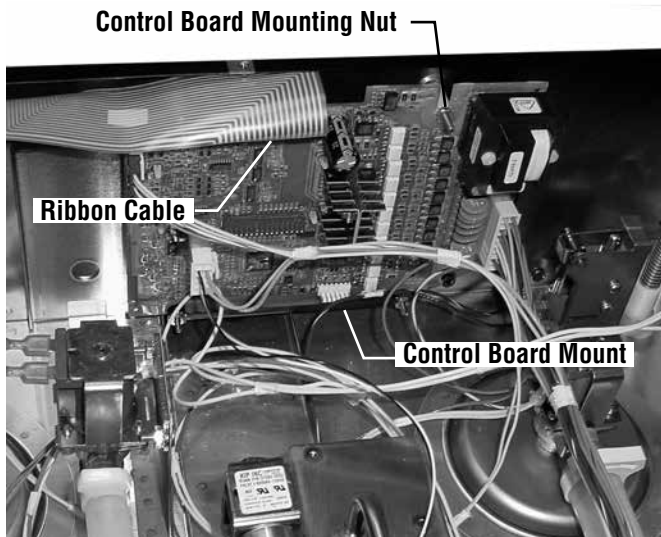

FIG 1 CONTROL BOARD MOUNTING

Location:

The Control Board (Fig 1) is located under the top cover behind the control panel.

Check for Power to board:

1. Insert one meter lead in J11-pin 12 and the other lead in J11-pin 14.
2. With the power connected to brewer, the voltage reading to the board should be the line voltage rated for that model.

If no voltage is present, check wiring to the board. If voltage is present, and brewer does not power on, replace board.

Removal and Replacement:

1. Disconnect brewer from power source.
2. Disconnect the funnel sensor(s) from connector J9 on the control board.
3. Disconnect the main harness from connector J11 on the control board.
4. Disconnect the ribbon cable from connector J4 on the control board.
5. Disconnect the level probe harness and server detect harness for SH models from connector J2 on the control board.
6. Remove the two mounting nuts securing the top of the control board to the hood.
7. Tilt the control board inward to clear the display section and lift out of the control board mount.
8. Place the bottom edge of the new control board in the control board mount, tilt the board forward, and secure with the two keps nuts.
9. Re-connect wires to the circuit board.

COMPONENT ACCESS (cont)

MEMBRANE SWITCH



FIG 2 MEMBRANE SWITCH

Location:

The Membrane Switch (Fig 2) is located on the front of the hood with a ribbon cable extending through the hood and connected to the control board.

Test Procedures:

There are two methods for testing the membrane switch. The easiest method is to use the built in test mode. Refer to the Trouble Shooting Section for Service Tools/Test Switches. If for some reason you can't get into the program modes, or brewer won't power up, you can test it with an ohmmeter or continuity tester. Refer to the schematic to trace the appropriate pins.

NOTE: Pin 1 is the static shield & will not provide a reading to the other pins. There are three commons in this circuit, pins #2, 11 & 12.

Disconnect brewer from power source before disconnecting ribbon cable from control board.

Removal and Replacement:

1. Disconnect the ribbon cable from 20-pin connector on the control board.
2. Disconnect the wires from funnel sensor(s) and remove sensor(s) from the front of the hood.
3. Gently peel the membrane switch from the hood.

4. Remove any adhesive that remains on the hood.
5. Remove the adhesive backing from the new membrane switch. Insert the ribbon cable through the slot in the hood and apply the membrane switch to the front of the hood.
6. Reconnect the ribbon cable to the 20-pin connector on the control board making sure every pin on the control board is inserted into the ribbon cable connector.

COMPONENT ACCESS (cont)

DISPENSE & BYPASS VALVES

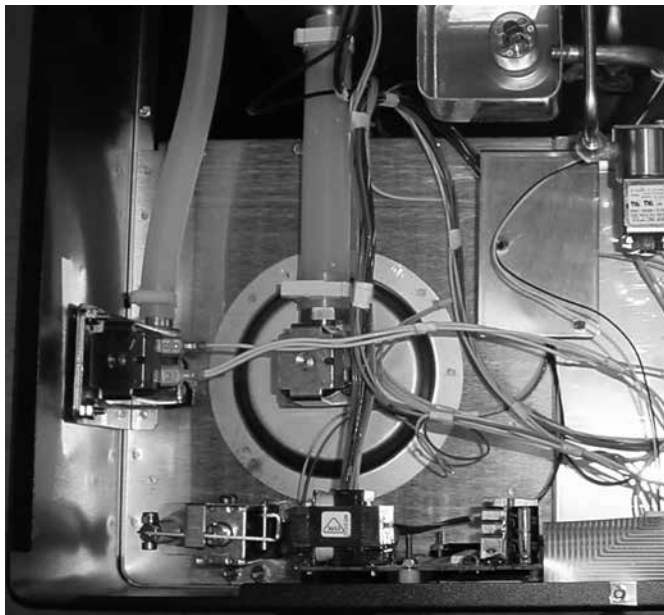

FIG 3 DISPENSE & BYPASS VALVES

Location:

The dispense and bypass valve(s) (Fig 3) are located inside the hood under the top cover.

Test Procedures:

1. Refer to the Trouble Shooting Section for Service Tools/Test Outputs/Dispense/Bypass Valve.
2. Be sure brew funnel & server are in place before activating valve.
3. Check the valve for coil action. Turn on the valve with the test mode. Listen carefully in the vicinity of the dispense/bypass valve for a click as the coil pulls the plunger in.

If no sound is heard as described, proceed to #4.

If the sound is heard as described, there may be a blockage in the valve, hose, tank, or sprayhead. Disconnect the brewer from the power source. Remove the valve and inspect for blockage, and de-lime all related areas.

4. Connect the voltmeter leads to the coil terminals. Turn on the valve with the test mode. **NOTE: Due to the internally rectified coil, the indication will be 120VAC all the time.** Set the meter to DC volts. The indication should be 170VDC when activated.

If the polarity of meter leads are reversed, reading will indicate -170VDC. (Double these readings for 240 volt coils)

If voltage is present as described, but no coil action is observed, valve is defective. Replace valve and test again to verify repair.

If voltage is not present as described, refer to Wiring Diagrams and check the brewer wiring harness. Also check the control board and switch for proper operation.

Removal and Replacement:

1. Disconnect the brewer from the power source.
2. Disconnect wires from the valve.
3. Drain enough water from the tank so the water level is below the outlet.
4. Remove tube(s) from the valve.
5. Dispense valve:
Remove the sprayhead and nut securing valve to the sprayhead panel.
Bypass valve:
Remove the two #8-32 mounting nuts.
6. Install new valve using nut(s) removed in step 5. Clean and install the sprayhead.
7. Reconnect tube(s) to the valve and secure in place with clamp(s).

COMPONENT ACCESS (cont)

REFILL VALVE

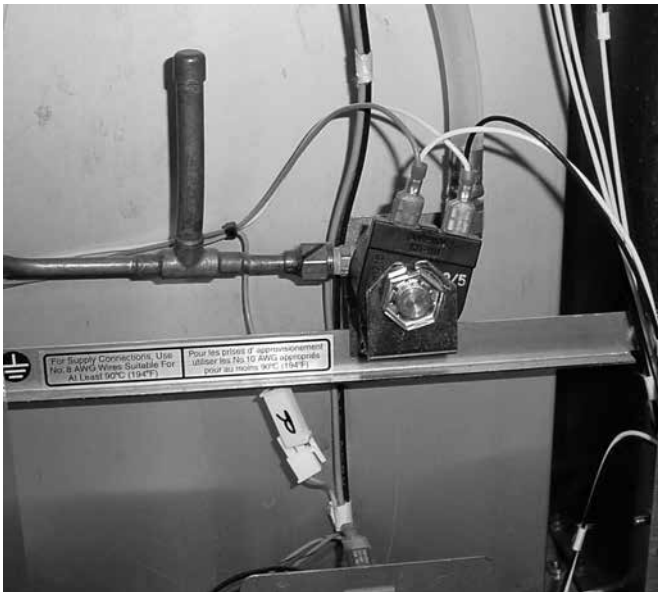

**FIG 4 REFILL VALVE
(DUAL SH DBC Models)**

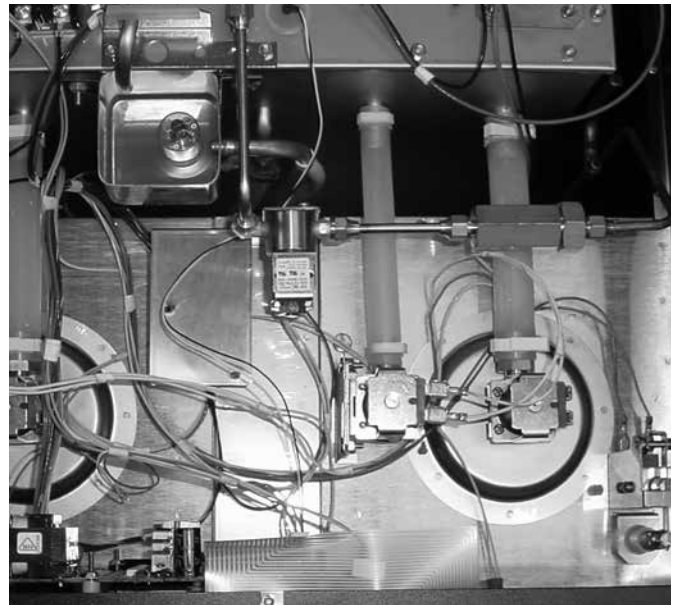

**FIG 6 REFILL VALVE
(DUAL TF DBC Early Models)**

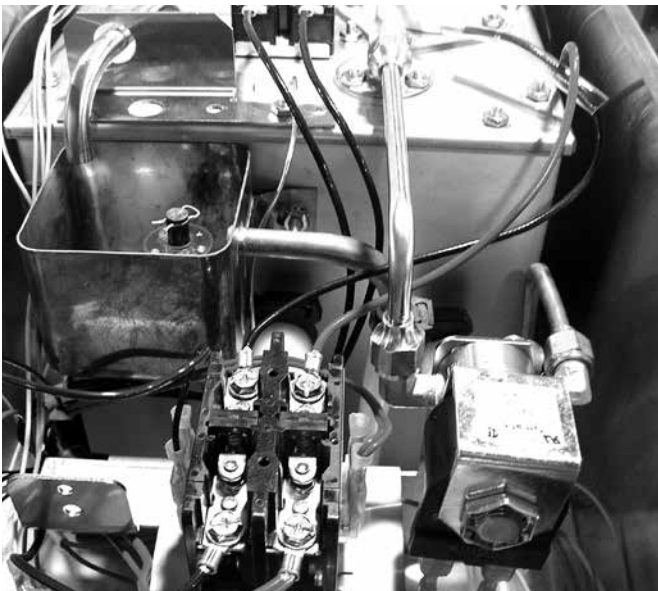

**FIG 5 REFILL VALVE
(SINGLE SH DBC Models)**



**FIG 7 REFILL VALVE
(DUAL TF DBC Late Models)**

COMPONENT ACCESS (cont)

REFILL VALVE (cont)

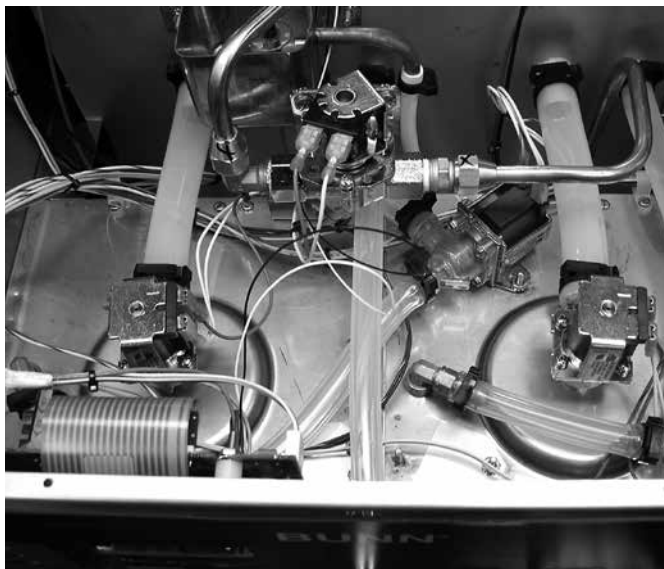

**FIG 8 REFILL VALVE
(DUAL GPR DBC Models)**

Location:

DUAL SH DBC models:

SINGLE TF DBC late models:

DUAL TF DBC late models:

The refill valve is located inside the front of the brewer behind the front access panel.

SINGLE SH DBC models:

SINGLE GPR DBC models:

SINGLE TF DBC early models:

DUAL GPR DBC models:

DUAL TF DBC early models:

The refill valve is located inside the hood of the brewer under the top cover.

Test Procedures:

1. Enter programming level 2, scroll to "Service Tools" then scroll to "Refill Valve".
2. Briefly activate the refill valve in the test mode. With a voltmeter, check the voltage across the coil wires.
3. The indication must be 120 volts ac for two wire 120 volt models, three wire 120/208, and 120/240 volt models or 230 volts ac for two wire 230 volt models.

If voltage is present, proceed to # 4.

If voltage is not present, refer to Wiring Diagrams and check main wiring harness. If harness checks ok, replace control board.

4. Check the refill valve for coil action. Briefly activate the refill valve in the test mode and listen carefully near the refill valve for a "clicking" sound as the magnetic coil pulls the plunger in.

If the sound is heard as described and water will not pass through the refill valve, there may be a blockage in the water line before the refill valve or, the solenoid valve may require inspection for wear, and removal of waterborne particles.

If the sound is not heard as described, proceed to # 5.

5. Disconnect the brewer from the power source.
6. Check for continuity across the refill valve coil terminals.

If continuity is not present as described, replace the refill valve.

If continuity is present as described, there could be some debris in the valve.

Removal and Replacement:

1. Shut off the water supply.
2. Remove both wires from the refill valve.
3. Disconnect both water lines at the valve.
4. Remove the two 1/4"-20 screws securing the valve to the component mounting bracket.
5. Using the two 1/4"-20 screws, install the new valve to the component mounting bracket.
6. Securely fasten the water lines to the valve.
7. Refer to wiring diagrams when reconnecting the wires.
8. Install access panels and covers and refer to Initial Set-up for refill and operation.

COMPONENT ACCESS (cont)

TANK HEATERS

Location:

The tank heaters (Fig 9) are located inside the tank, secured to the tank lid.

Test Procedures:

1. With a voltmeter, check voltage across the white wire (120V Models) or red wire (120/208 and 120/240V Models) and blue wire on the top of the tank heaters. Connect brewer to the power source. The indication must be 120 volts ac for two wire 120 volt models, 208 volts ac for three wire 120/208 volt models and 240 volts ac for 120/240 volt models (during a heating cycle).
2. Disconnect the brewer from the power source.

If voltage is present as described, proceed to #3.

If voltage is not present as described, refer to the Wiring Diagrams and check wiring harness. If harness checks ok, replace control board.

3. Disconnect the wires from the tank heater terminals.
4. Check resistance value across tank heater terminals and compare to chart.

If resistance is present as described, reconnect the wires, the tank heater is ok.

If resistance is not present as described, replace the tank heater.

NOTE- If any resistance is read between sheath and either terminal, remove and inspect heater for cracks in the sheath.



FIG 9 TANK HEATERS

Removal and Replacement:

1. Remove the top cover from the brewer.
2. Disconnect the wires from tank heater terminals.
3. Remove the four #8-32 nuts securing the tank heater(s) to the tank lid assembly.
4. Remove tank heater(s) with gasket(s) and discard.
5. Install new tank heater(s) with gasket(s) to the tank lid assembly with the original nuts.
6. Reconnect the wires to the tank heater(s) terminals.

HEATER	RESISTANCE
1800W-120V	8.05 Ω
2200W-120V	6.54 Ω
2850W-208V	15.25 Ω
3300W-240V	18.81 Ω
4000W-208V	11.0 Ω
4000W-240V	14.47 Ω
5000W-240V	11.65 Ω
TERMINAL TO SHEATH - INFINITE (OPEN)	

COMPONENT ACCESS (cont)

TEMPERATURE PROBE

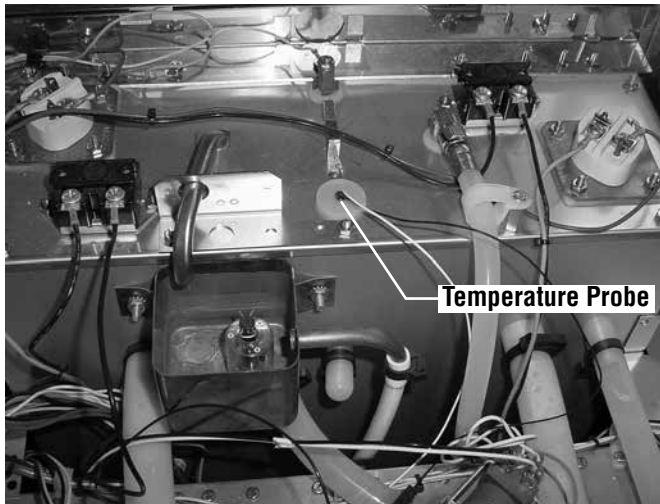

FIG 10 TEMPERATURE PROBE

Location:

The temperature probe (Fig 10) is inserted into a grommet in the tank lid assembly.

Test Procedures:

1. Disconnect the brewer from the power source.
2. With a DC voltmeter, check voltage across the black and white wires at J2 on control board (Black voltmeter probe to black wire, red voltmeter probe to white wire). Connect the brewer to the power source. The indication should be approximately between 4vdc cool to 1vdc at ready temperature.
3. Disconnect the brewer from the power source.

If voltage is present as described, circuit is working correctly, check limit thermostat (and TCO on 200V and 230V models).

If voltage is not present as described, proceed to #4.

4. Disconnect temperature probe from J2 on control board. Check the resistance across the two terminals of the temperature probe. The indication should be approximately between 10.5K Ω cool to 870 Ω at ready temperature.

If resistance is to specification, replace the control board.

If resistance is not to specification, replace the temperature probe.

Removal and Replacement:

1. Disconnect the brewer from the power source.
2. Refer to instructions included in Temperature Probe Kit #29327.0000 to replace Temperature Probe.

LIMIT THERMOSTAT

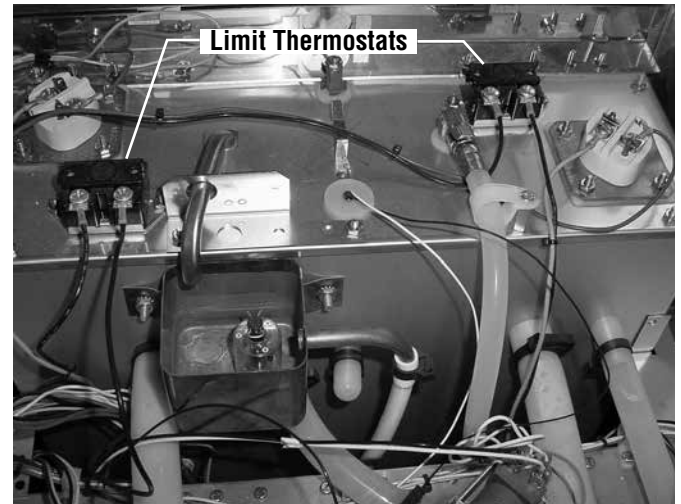

FIG 11 LIMIT THERMOSTATS

Location:

The limit thermostats (Fig 11) are located under the top cover on the tank lid assembly.

Test Procedures:

1. Disconnect the brewer from the power source.
2. Disconnect the wires from the limit thermostat.
3. With an ohmmeter, check for continuity across the limit thermostat terminals.

If continuity is present as described, the limit thermostat is operating properly.

If continuity is not present as described, replace the limit thermostat.

Removal and Replacement:

1. Remove the wires from limit thermostat terminals.
2. Remove the two #8-32 nuts securing the limit thermostat to the tank lid and lift limit thermostat off the studs.
3. Install the new limit thermostat onto the studs on the tank lid and secure with original nuts.
4. Connect the wires to the limit thermostat.

COMPONENT ACCESS (cont)

WARMER ELEMENTS (GPR MODELS)

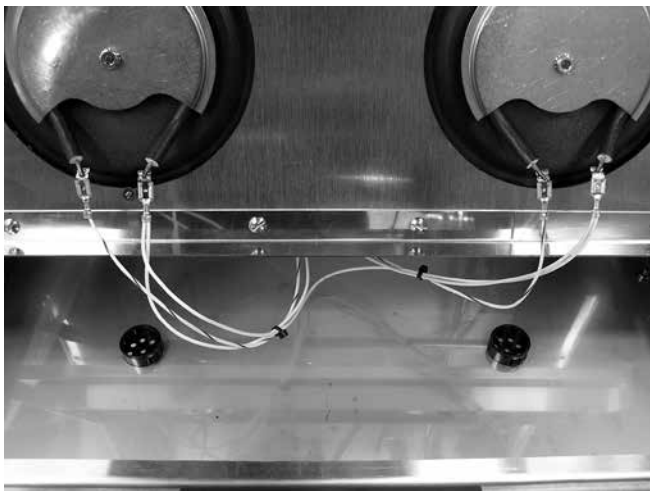

FIG 12 WARMER ELEMENTS

Location:

The warmer element(s) (FIG 12) is located under the warmer plate(s).

Test Procedures:

1. Disconnect the brewer from the power source.
2. With a voltmeter, check voltage across the two wires at the warmer element with the "ON/OFF" switch in the "ON" position. Connect the brewer to the power source. The indication must be 120 volts ac.
3. Disconnect the brewer from the power source.

If voltage is present as described, proceed to #4.

If voltage is not present as described, refer to Wiring Diagrams and check wiring harness.

4. Check the resistance across the two terminals on warmer element. Resistance should be 144.0 Ω , terminal to sheath - infinite (open).

If resistance is to specification, reconnect the two wires to the warmer element.

If resistance is not to specification, replace the warmer element.

Removal and Replacement:

1. Remove the three #4-40 screws securing the warmer assembly to the brewer.
2. Lift the warmer assembly from the brewer.
3. Disconnect the two wires from the warmer element terminals.
4. Remove the two #8-32 nuts securing the warmer element to the warmer plate.
5. Securely install new warmer element.
6. Reconnect the two wires to warmer element terminals.
7. Securely install warmer assembly on the brewer.

MASTER POWER SWITCH



FIG 13 MASTER POWER SWITCH

Location:

The main power switch (FIG 13) is located under the brewer in the base just behind the right front leg on SH and GPR models and behind the front support leg on TF models.

Test Procedure:

1. Disconnect the brewer from the power source.
2. Disconnect the wires from the power switch. With the switch in the ON position, check for continuity between terminals opposite each other.

There should be continuity between the two terminals on each side when the switch is in the ON position, no continuity when in the OFF position.

COMPONENT ACCESS (cont)

MASTER POWER SWITCH (cont)

If continuity is not present as described, replace the switch.

Removal and Replacement:

1. Disconnect the brewer from the power source.
2. Disconnect the wires from the power switch.
3. Remove the switch mounting screws from the under the base.
4. Install new switch in trunk with the two 6-32 x 1/4" mounting screws.
5. Connect wires to the switch terminals.

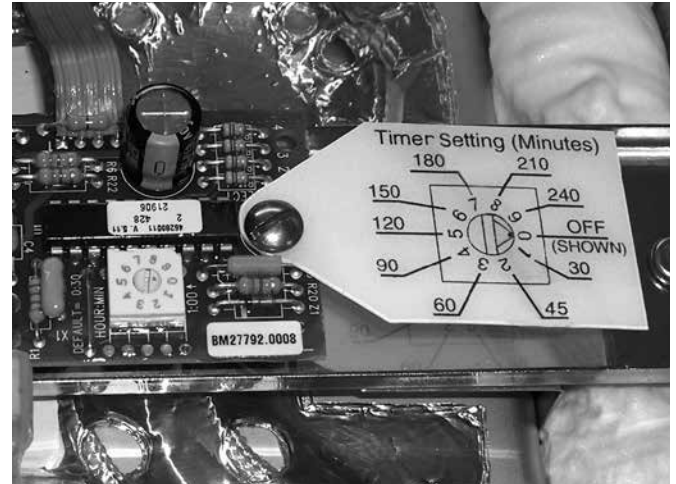

FIG 15 TIMER & TAG

SH SERVER TIMER SETTING

Timer may be set to the OFF position as shown on Tag (Fig 15) to prevent the LED on the front of the server from flashing, or one of nine various settings to flash the LED after Timer has expired. For instance, setting Timer on position 5 will flash the LED after 120 minutes. Server must be docked on a SH Brewer or SH Server Stand to engage Timer.

INSTRUCTIONS:

- Empty all contents and turn server upside down.
- Remove two screws (Fig 14) securing bottom cover to server, remove bottom cover from server.
- Refer to the Timer Setting Tag (Fig 15) to determine the desired timer setting number.
- Using a small flat blade screwdriver, set the Timer to the corresponding number (Fig 16).
- Install the bottom cover on server and secure with screws.

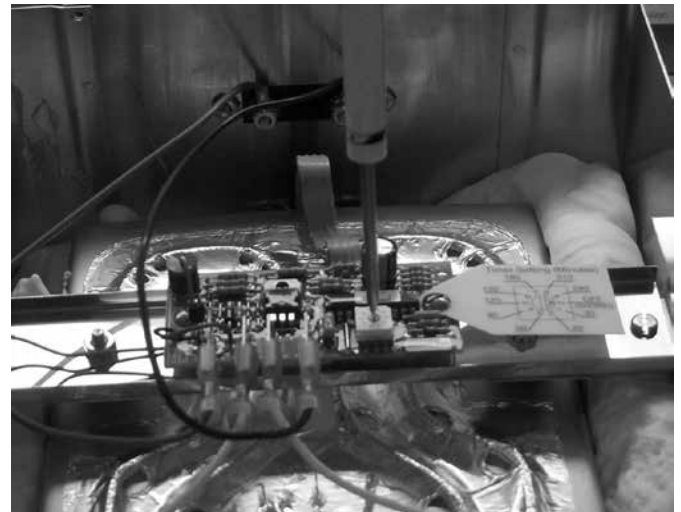
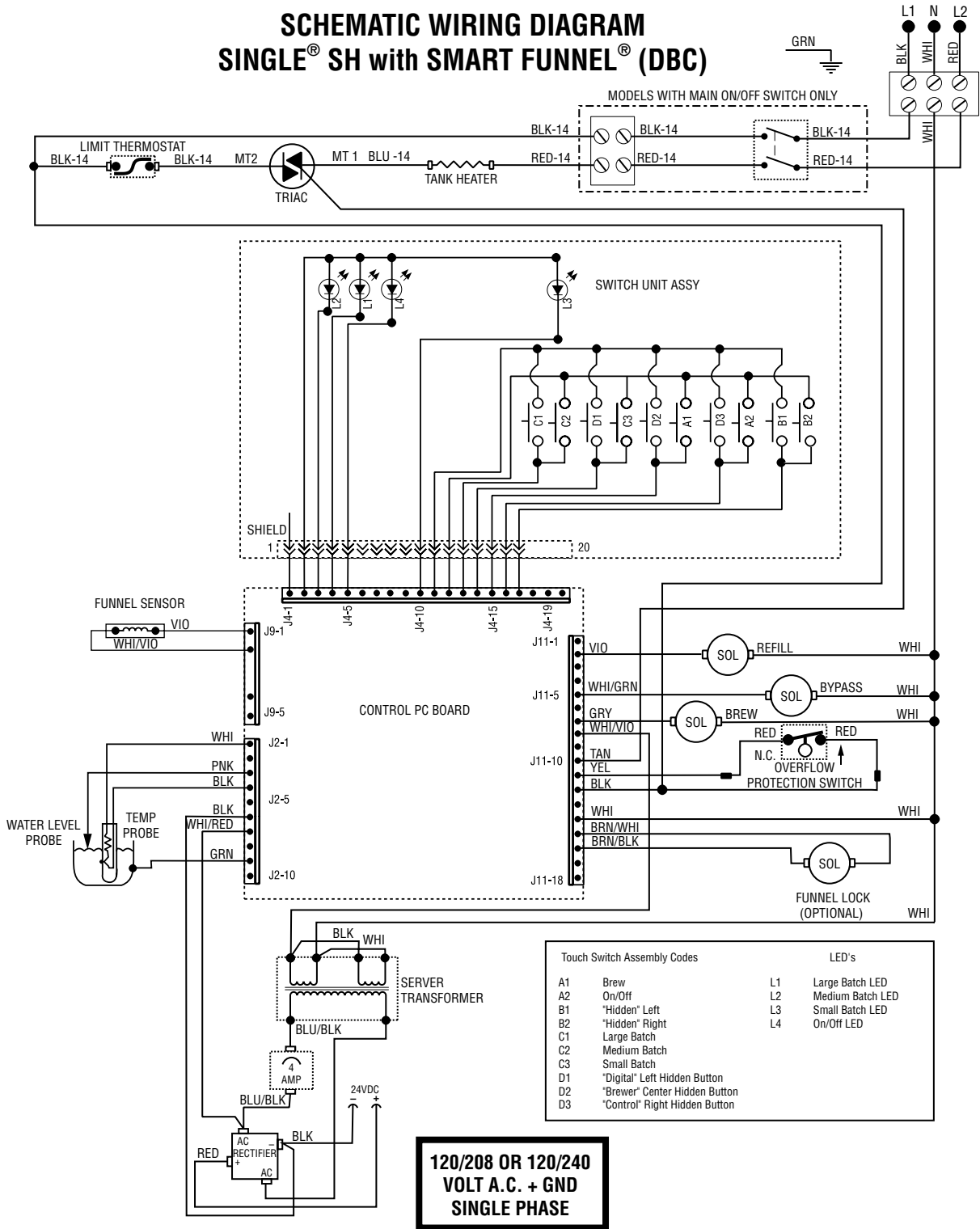

FIG 16 SETTING TIMER

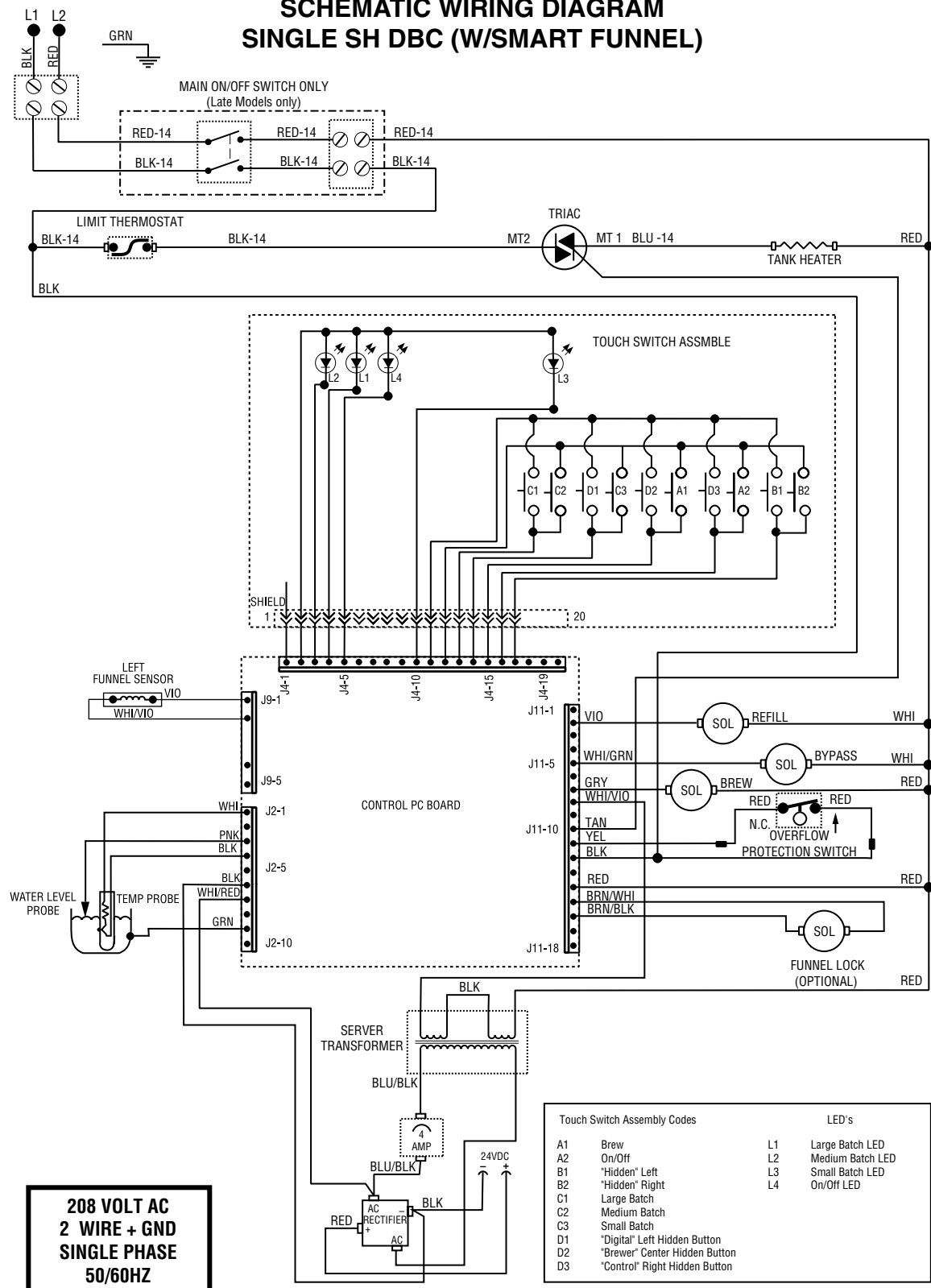

FIG 14 REMOVE BOTTOM COVER

SCHEMATIC WIRING DIAGRAM SINGLE® SH with SMART FUNNEL® (DBC)



SCHEMATIC WIRING DIAGRAM SINGLE SH DBC (W/SMART FUNNEL)



SCHEMATIC WIRING DIAGRAM SINGLE SH DBC (W/SMART FUNNEL) (With Thermal Safety Fuse)

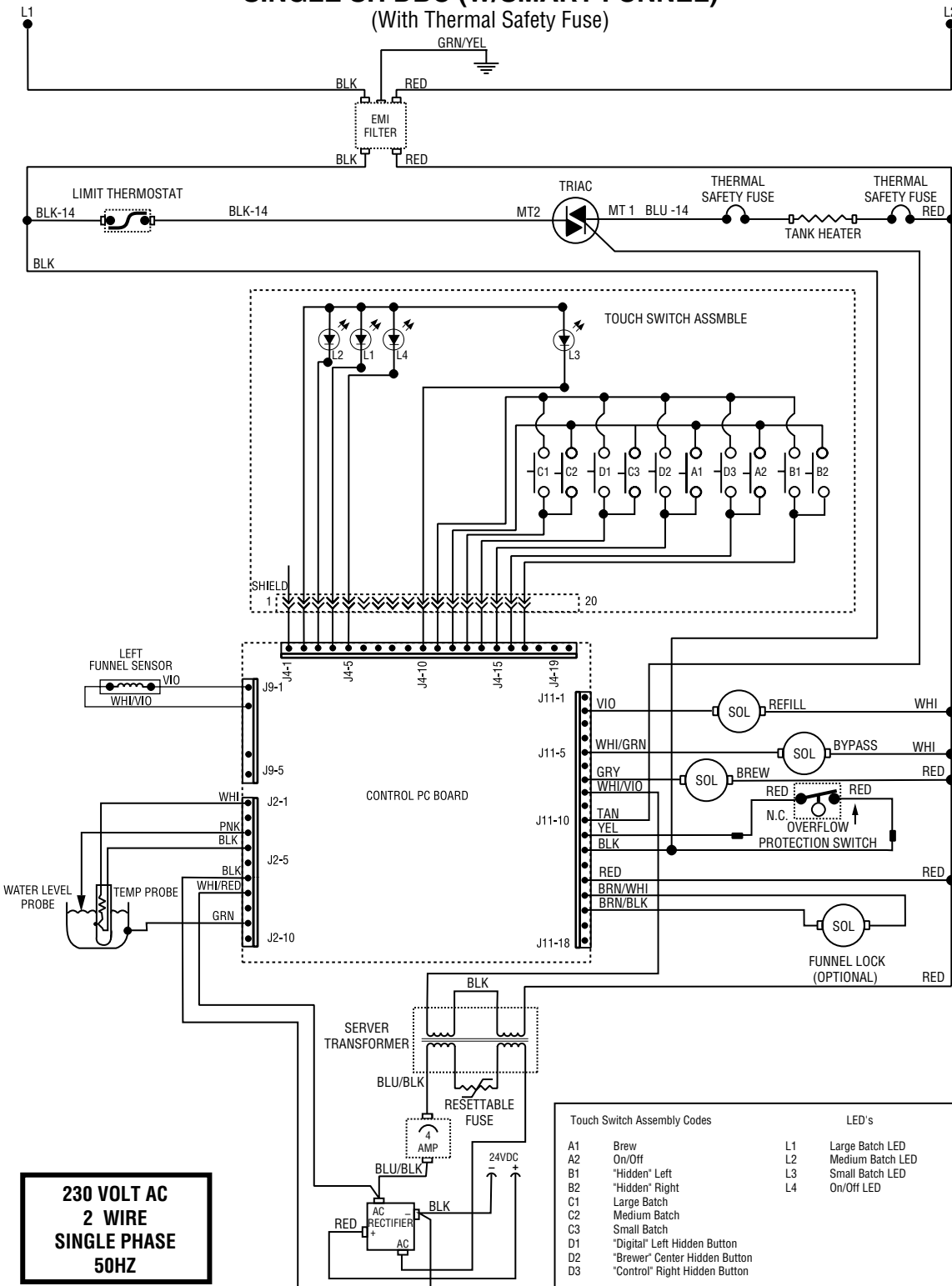

SCHEMATIC WIRING DIAGRAM SINGLE SH DBC (W/SMART FUNNEL)

(With Limit Thermostat)

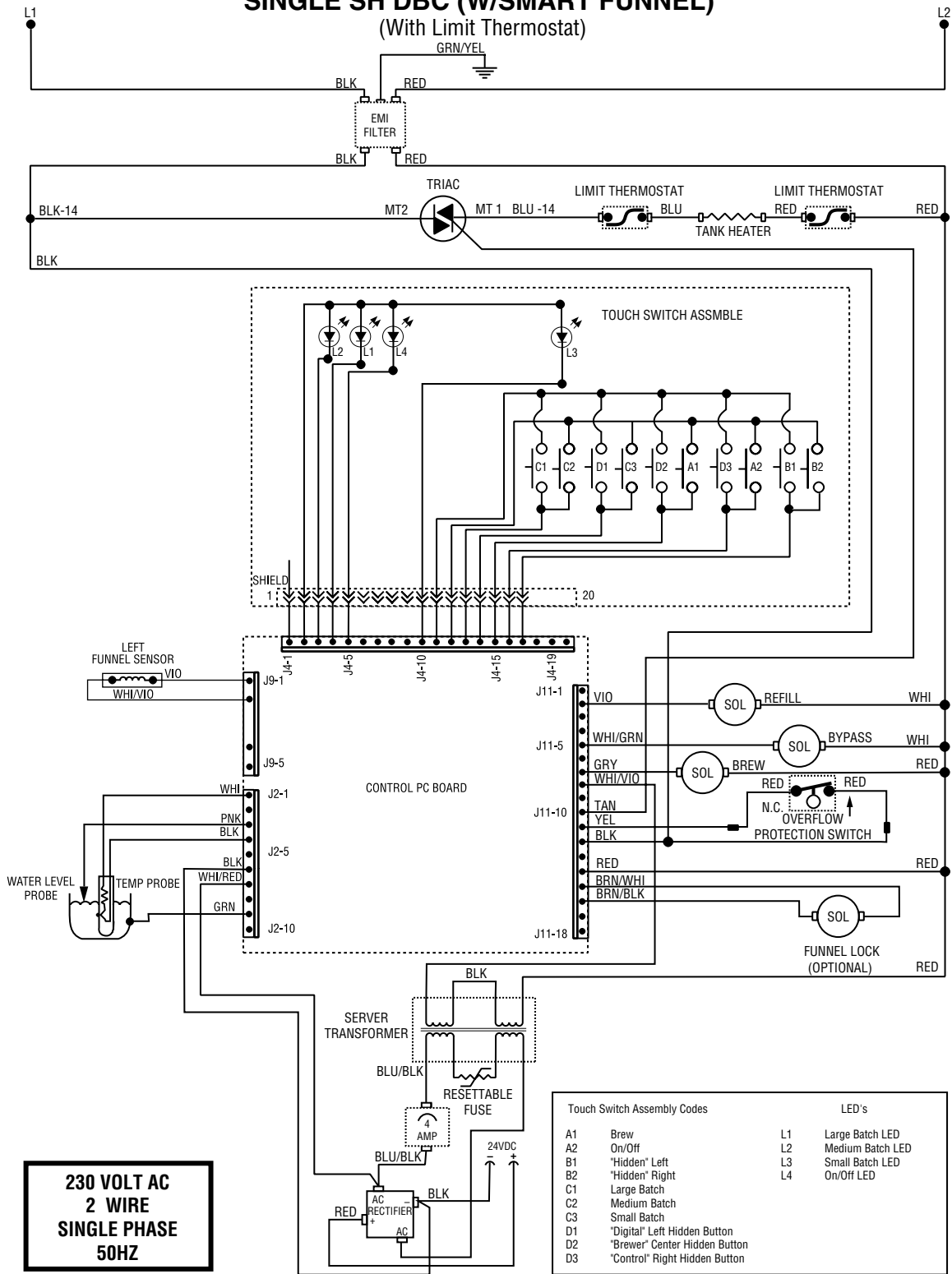

SCHEMATIC WIRING DIAGRAM SINGLE SH DBC (W/SMART FUNNEL)

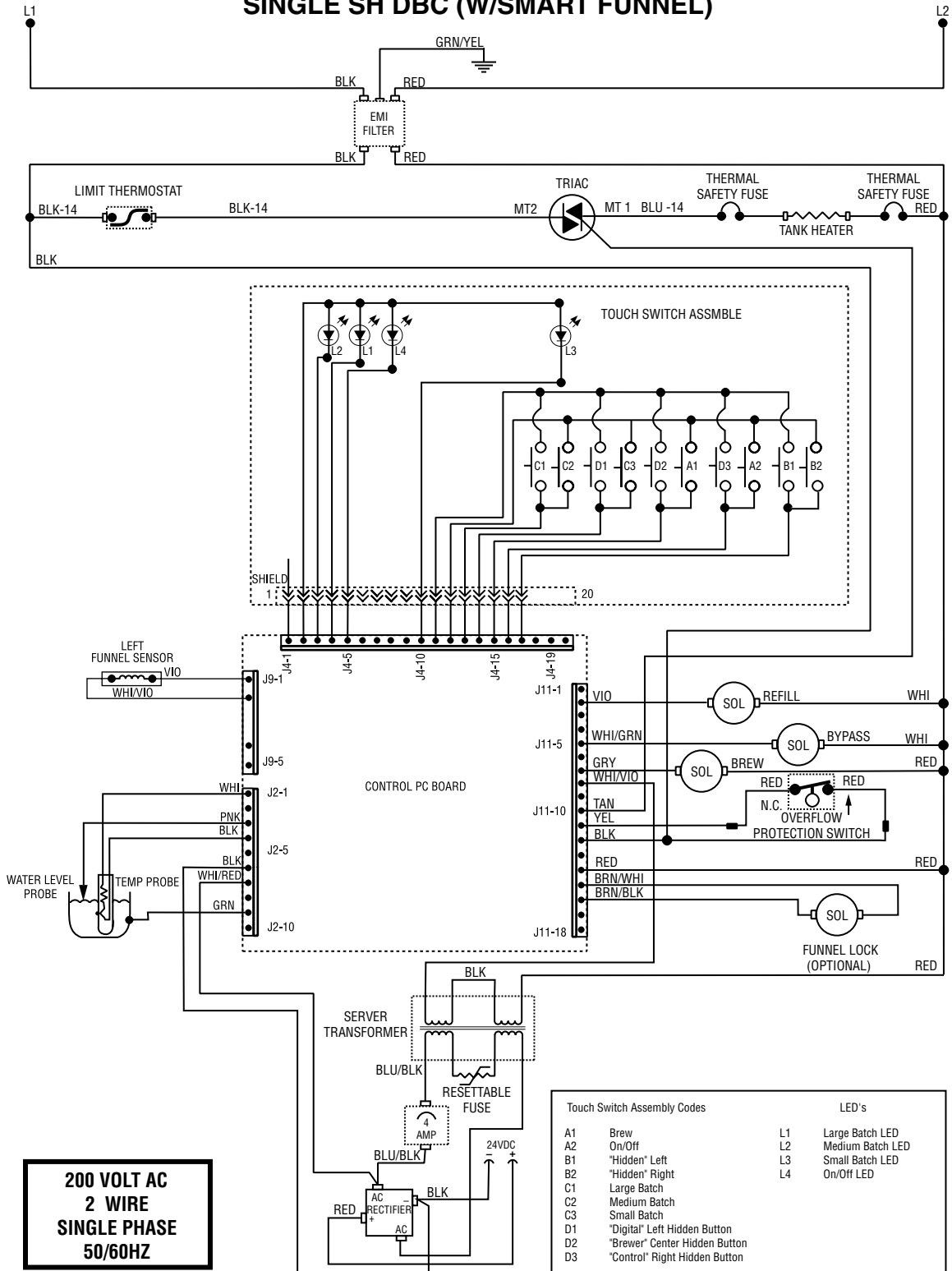

SCHEMATIC WIRING DIAGRAM SINGLE[®] SH with SMART FUNNEL[®] (DBC)

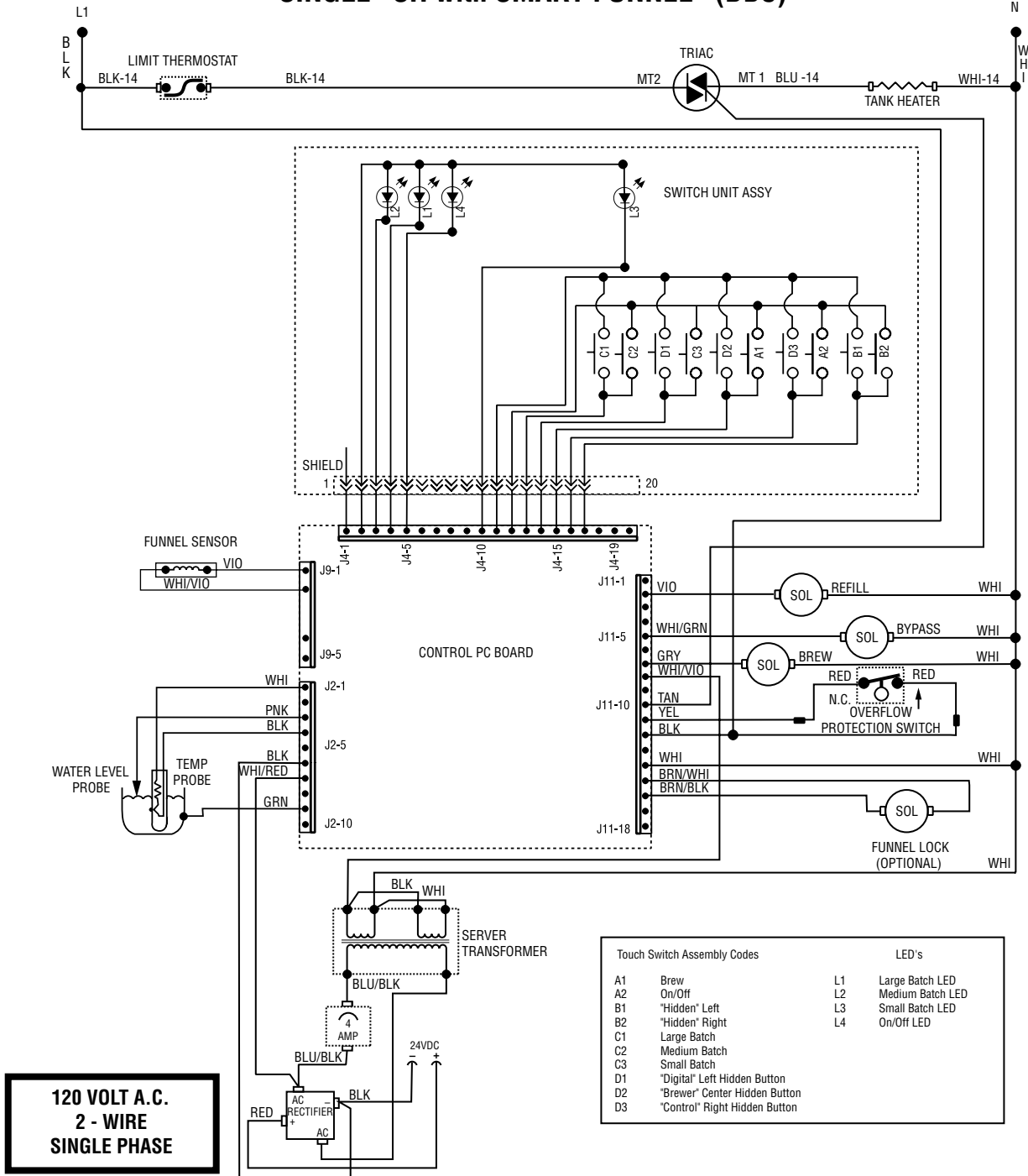

SCHEMATIC WIRING DIAGRAM SINGLE SH DBC with SMART FUNNEL (With Audible Alarm)

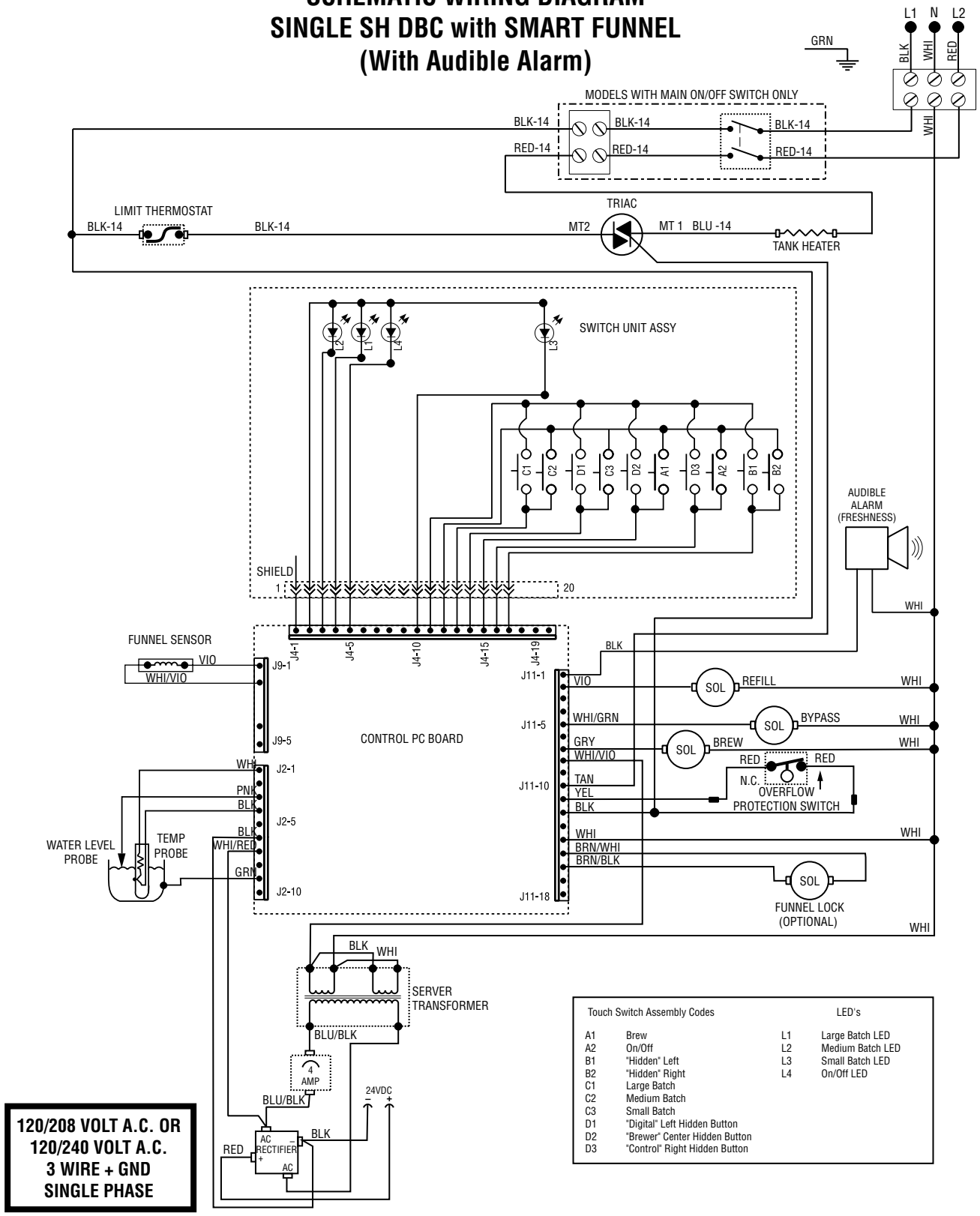

SCHEMATIC WIRING DIAGRAM SINGLE SH DBC (W/SMART FUNNEL)

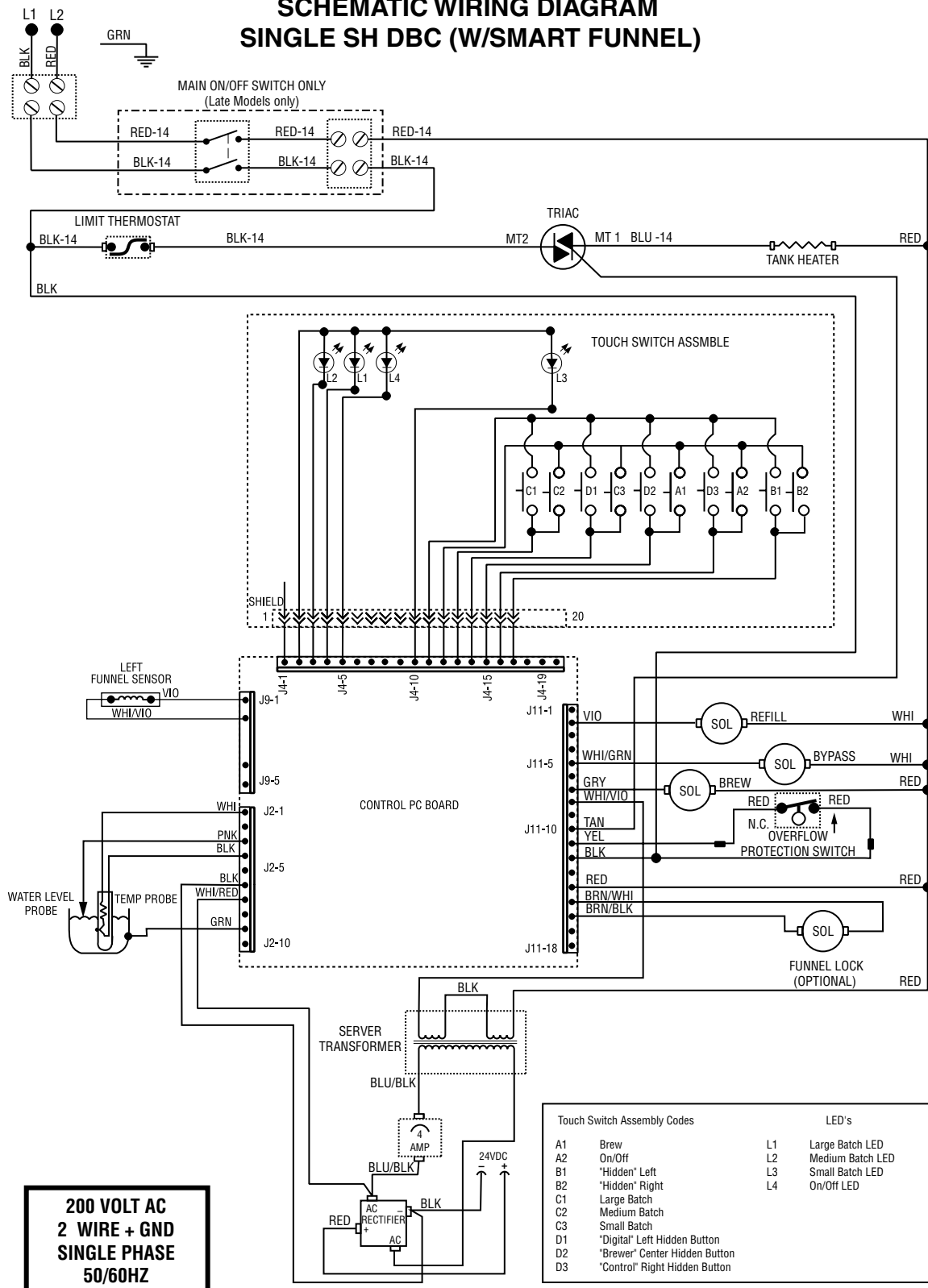

SCHEMATIC WIRING DIAGRAM DUAL SH with SMART FUNNEL (DBC)

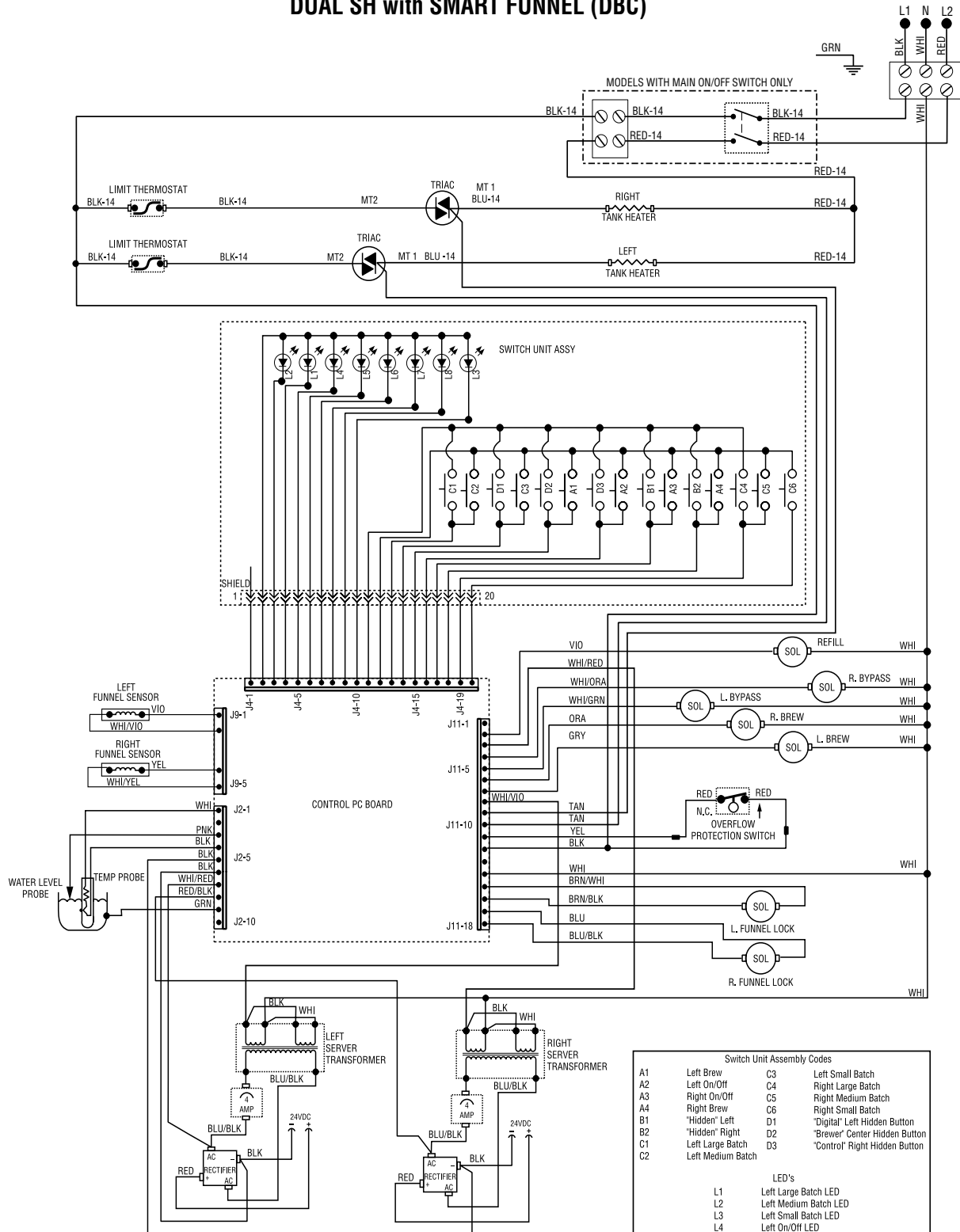

**120/208 OR 120/240
VOLT A.C. + GND
SINGLE PHASE**

Switch Unit Assembly Codes			
A1	Left Brew	C3	Left Small Batch
A2	Left On/Off	C4	Right Large Batch
A3	Right On/Off	C5	Right Medium Batch
A4	Right Brew	C6	Right Small Batch
B1	"Hidden" Left	D1	"Digital" Left Hidden Button
B2	"Hidden" Right	D2	"Brewer" Center Hidden Button
C1	Left Large Batch	D3	"Control" Right Hidden Button
C2	Left Medium Batch		

LED's	
L1	Left Large Batch LED
L2	Left Medium Batch LED
L3	Left Small Batch LED
L4	Left On/Off LED
L5	Right On/Off LED
L6	Right Large Batch LED
L7	Right Medium Batch LED
L8	Right Small Batch LED

SCHEMATIC WIRING DIAGRAM DUAL SH DBC (W/SMART FUNNEL)

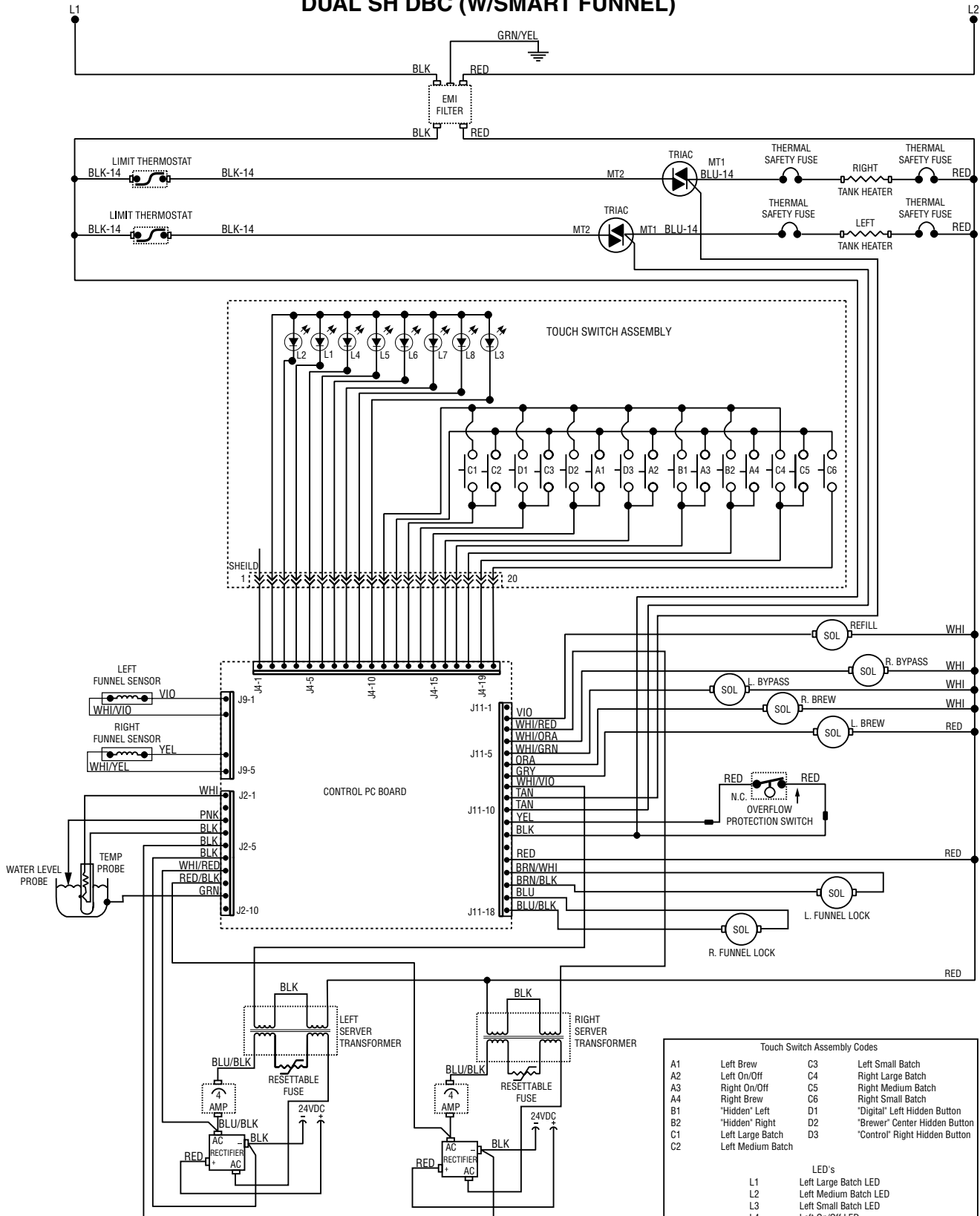

**230 VOLTS AC
2 WIRE
SINGLE PHASE
50HZ**

Touch Switch Assembly Codes			
A1	Left Brew	C3	Left Small Batch
A2	Left On/Off	C4	Right Large Batch
A3	Right On/Off	C5	Right Medium Batch
A4	Right Brew	C6	Right Small Batch
B1	"Hidden" Left	D1	"Digital" Left Hidden Button
B2	"Hidden" Right	D2	"Brewer" Center Hidden Button
C1	Left Large Batch	D3	"Control" Right Hidden Button
C2	Left Medium Batch		
LED's			
L1	Left Large Batch LED		
L2	Left Medium Batch LED		
L3	Left Small Batch LED		
L4	Left On/Off LED		
L5	Right On/Off LED		
L6	Right Large Batch LED		
L7	Right Medium Batch LED		
L8	Right Small Batch LED		

SCHEMATIC WIRING DIAGRAM DUAL SH DBC (W/SMART FUNNEL)

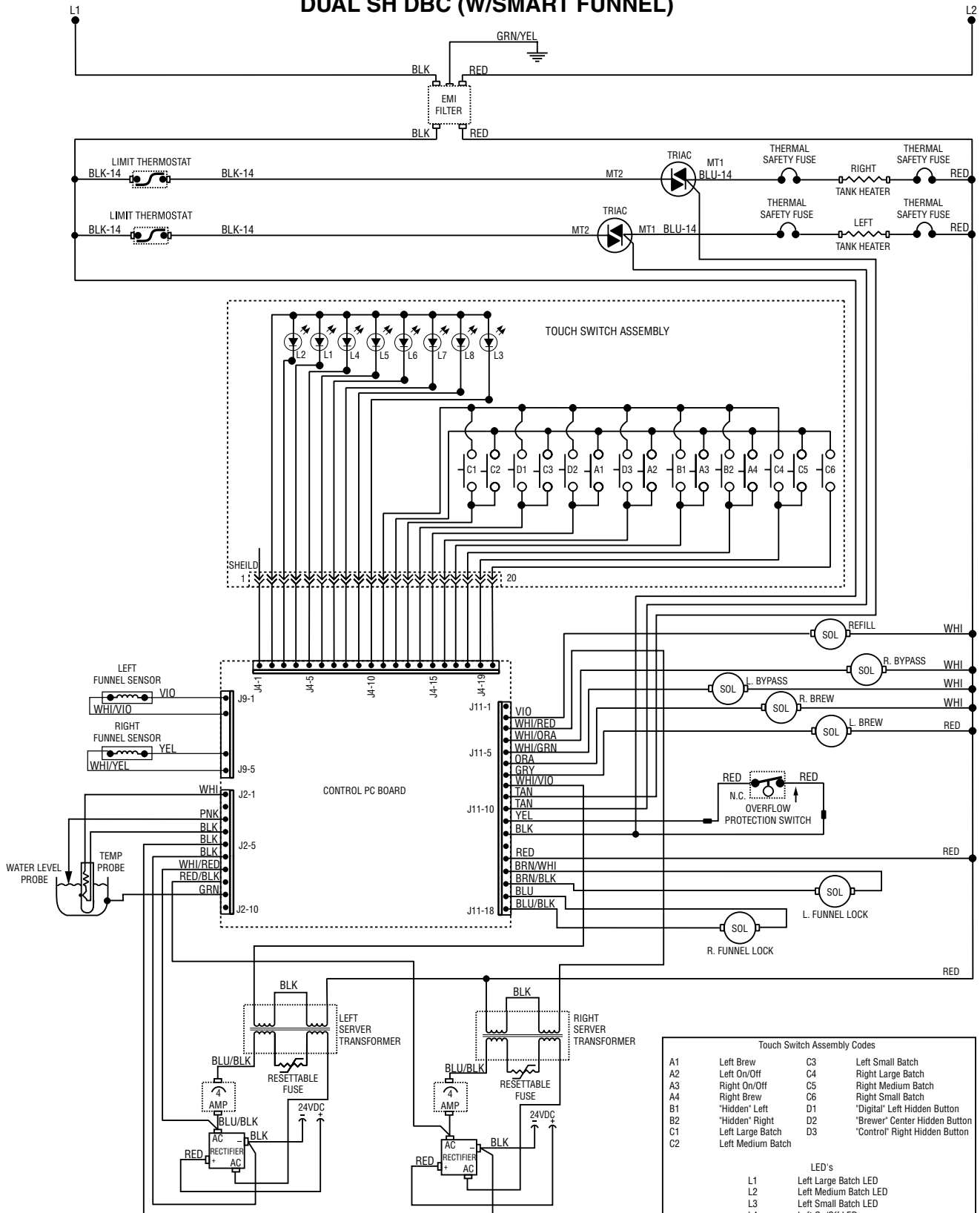

**200 VOLTS AC
2 WIRE
SINGLE PHASE
50/60HZ**

Touch Switch Assembly Codes			
A1	Left Brew	C3	Left Small Batch
A2	Left On/Off	C4	Right Large Batch
A3	Right On/Off	C5	Right Medium Batch
A4	Right Brew	C6	Right Small Batch
B1	'Hidden' Left	D1	'Digital' Left Hidden Button
B2	'Hidden' Right	D2	'Brewer' Center Hidden Button
C1	Left Large Batch	D3	'Control' Right Hidden Button
C2	Left Medium Batch		

LED's	
L1	Left Large Batch LED
L2	Left Medium Batch LED
L3	Left Small Batch LED
L4	Left On/Off LED
L5	Right On/Off LED
L6	Right Large Batch LED
L7	Right Medium Batch LED
L8	Right Small Batch LED

SCHEMATIC WIRING DIAGRAM SINGLE GPR DBC-DV with SMART FUNNEL

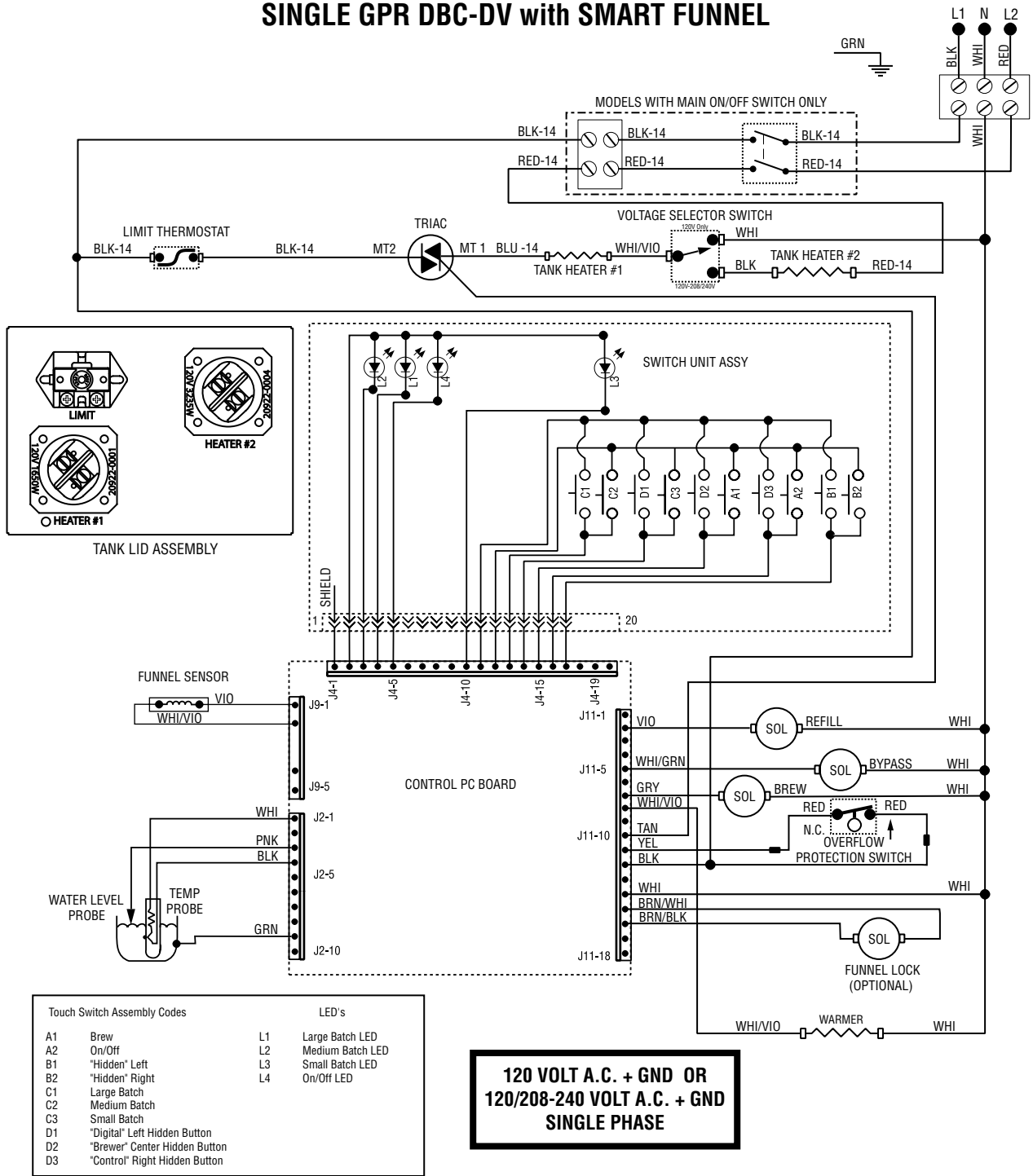

Touch Switch Assembly Codes		LED's	
A1	Brew	L1	Large Batch LED
A2	On/Off	L2	Medium Batch LED
B1	"Hidden" Left	L3	Small Batch LED
B2	"Hidden" Right	L4	On/Off LED
C1	Large Batch		
C2	Medium Batch		
C3	Small Batch		
D1	"Digital" Left Hidden Button		
D2	"Brewer" Center Hidden Button		
D3	"Control" Right Hidden Button		

**120 VOLT A.C. + GND OR
120/208-240 VOLT A.C. + GND
SINGLE PHASE**

SCHEMATIC WIRING DIAGRAM DUAL GPR with SMART FUNNEL (DBC)

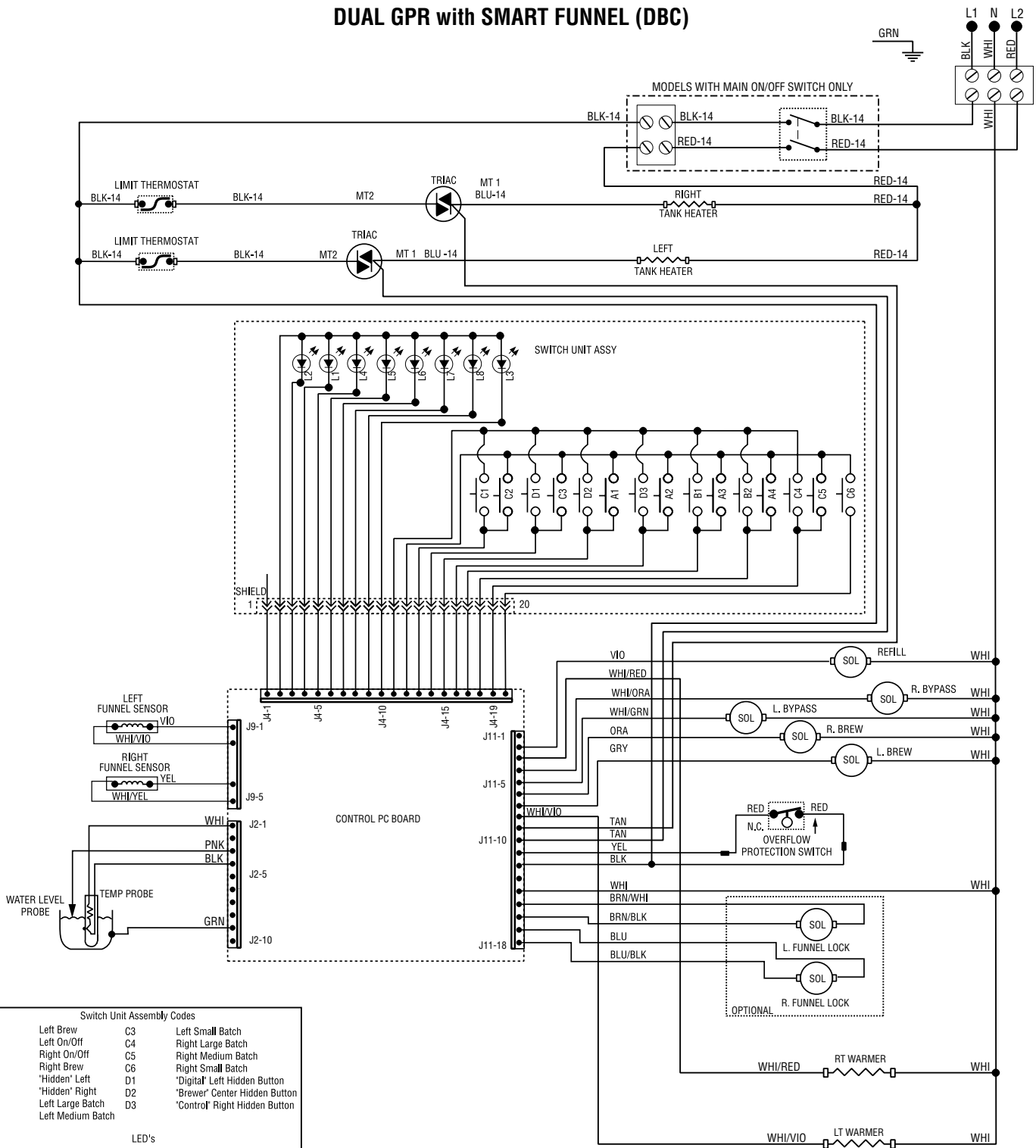

Switch Unit Assembly Codes			
A1	Left Brew	C3	Left Small Batch
A2	Left On/Off	C4	Right Large Batch
A3	Right On/Off	C5	Right Medium Batch
A4	Right Brew	C6	Right Small Batch
B1	"Hidden" Left	D1	"Digital" Left Hidden Button
B2	"Hidden" Right	D2	"Brewer" Center Hidden Button
C1	Left Large Batch	D3	"Control" Right Hidden Button
C2	Left Medium Batch		

LED's	
L1	Left Large Batch LED
L2	Left Medium Batch LED
L3	Left Small Batch LED
L4	Left On/Off LED
L5	Right On/Off LED
L6	Right Large Batch LED
L7	Right Medium Batch LED
L8	Right Small Batch LED

**120/208 OR 120/240
VOLT A.C. + GND
SINGLE PHASE**

SCHEMATIC WIRING DIAGRAM SINGLE TF DBC

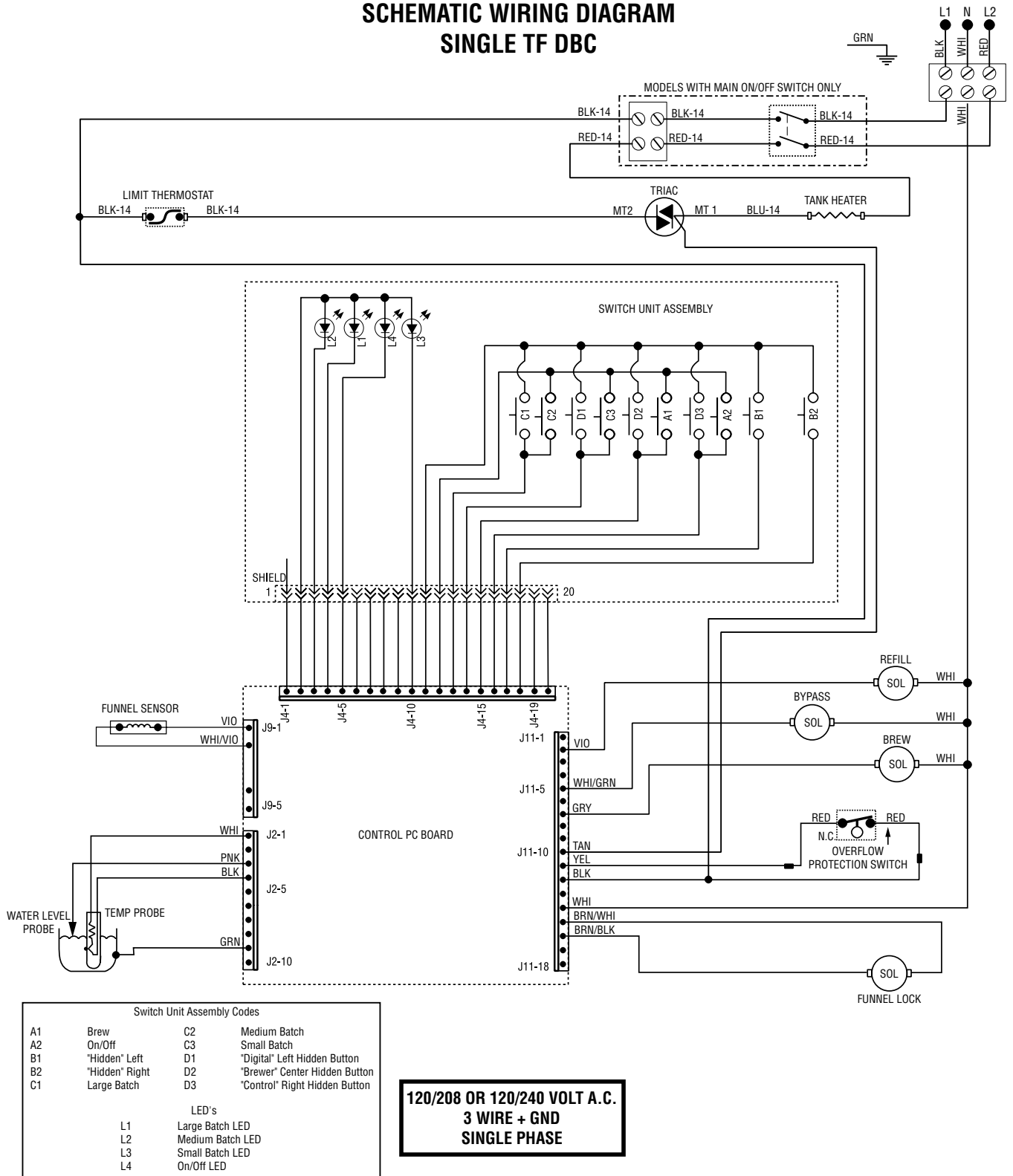

SCHEMATIC WIRING DIAGRAM SINGLE TF DBC

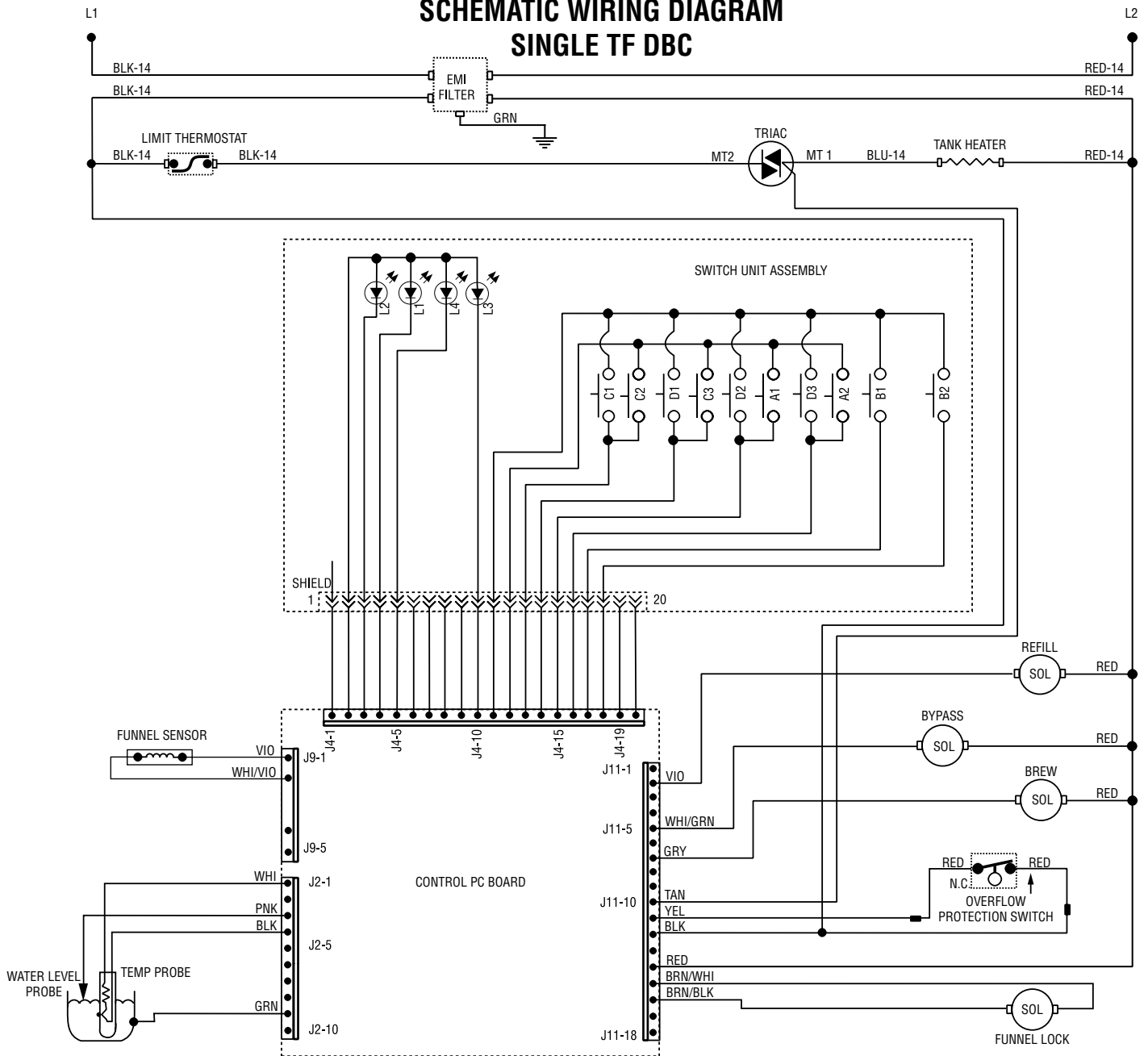

Switch Unit Assembly Codes			
A1	Brew	C2	Medium Batch
A2	On/Off	C3	Small Batch
B1	"Hidden" Left	D1	"Digital" Left Hidden Button
B2	"Hidden" Right	D2	"Brewer" Center Hidden Button
C1	Large Batch	D3	"Control" Right Hidden Button
LED's			
L1	Large Batch LED		
L2	Medium Batch LED		
L3	Small Batch LED		
L4	On/Off LED		

**230 OR 200
VOLT A.C.
SINGLE PHASE**

SCHEMATIC WIRING DIAGRAM SINGLE TF DBC

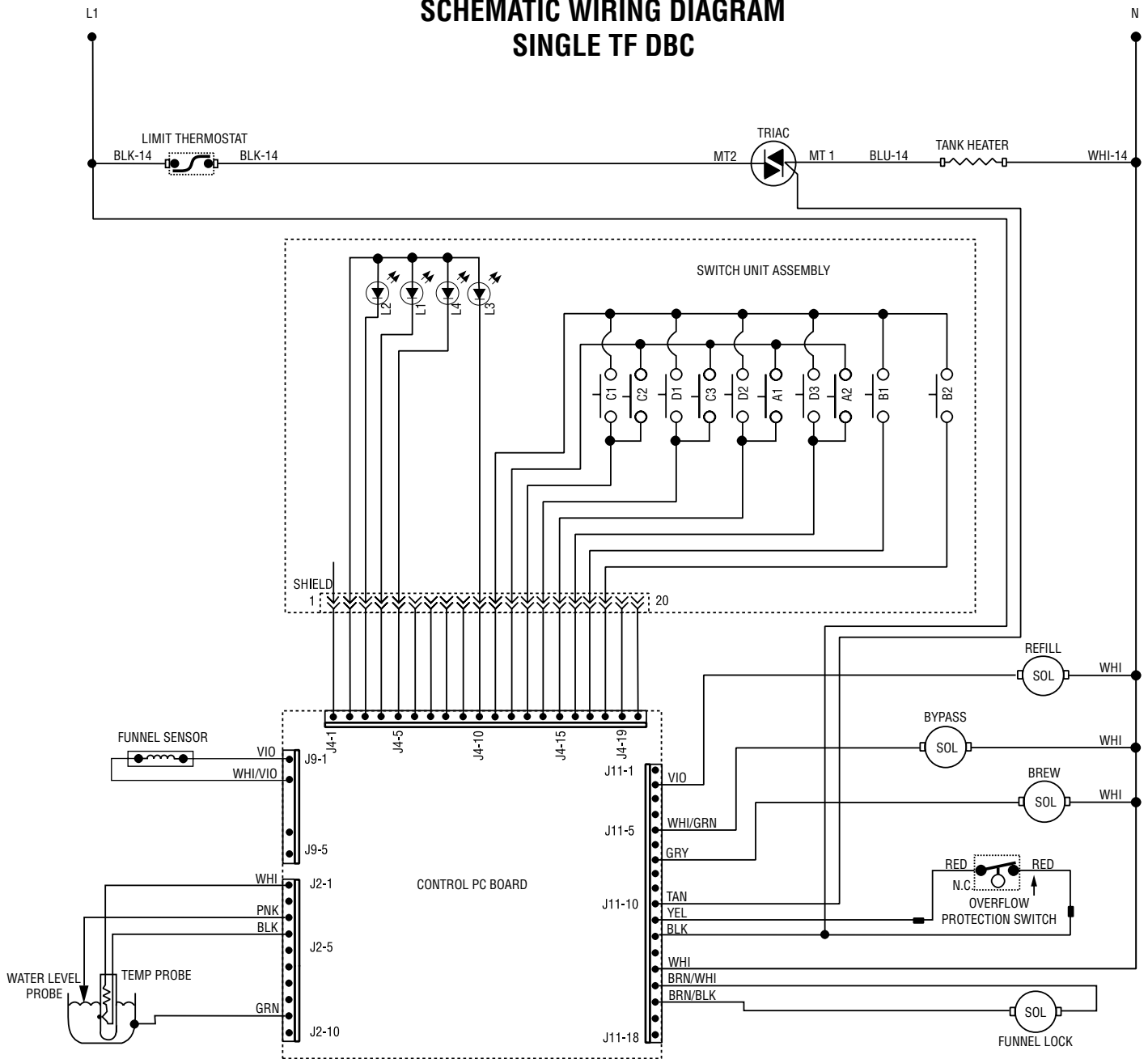

Switch Unit Assembly Codes			
A1	Brew	C2	Medium Batch
A2	On/Off	C3	Small Batch
B1	"Hidden" Left	D1	"Digital" Left Hidden Button
B2	"Hidden" Right	D2	"Brewer" Center Hidden Button
C1	Large Batch	D3	"Control" Right Hidden Button
LED's			
L1	Large Batch LED		
L2	Medium Batch LED		
L3	Small Batch LED		
L4	On/Off LED		

**120 VOLT A.C.
2 WIRE SINGLE PHASE
60HZ**

SCHEMATIC WIRING DIAGRAM SINGLE TF DBC

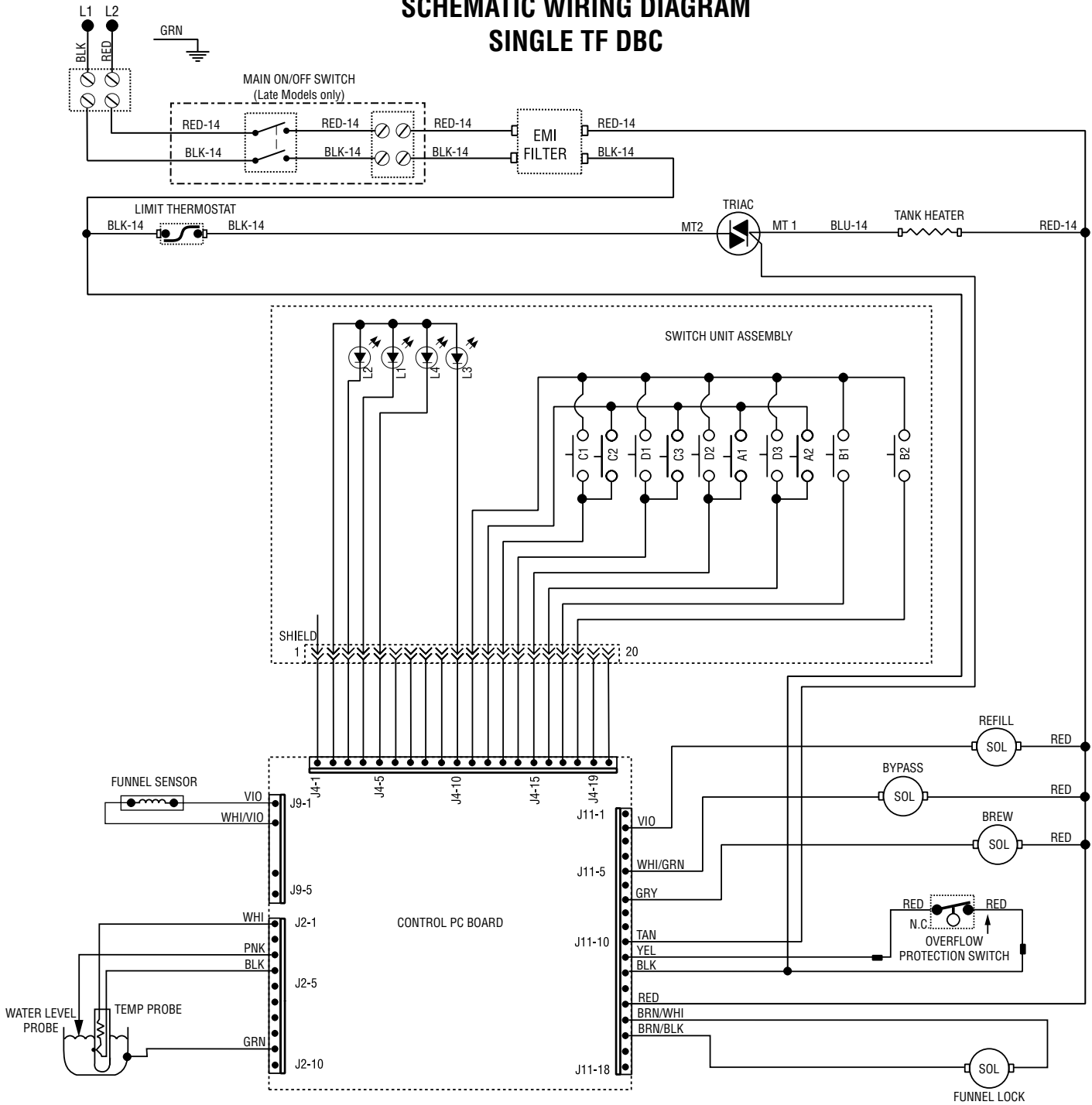

Switch Unit Assembly Codes			
A1	Brew	C2	Medium Batch
A2	On/Off	C3	Small Batch
B1	"Hidden" Left	D1	"Digital" Left Hidden Button
B2	"Hidden" Right	D2	"Brewer" Center Hidden Button
C1	Large Batch	D3	"Control" Right Hidden Button
LED's			
L1	Large Batch LED		
L2	Medium Batch LED		
L3	Small Batch LED		
L4	On/Off LED		

**200 VOLT A.C.
2 WIRE + GND
SINGLE PHASE 50/60HZ**

SCHEMATIC WIRING DIAGRAM SINGLE TF DBC

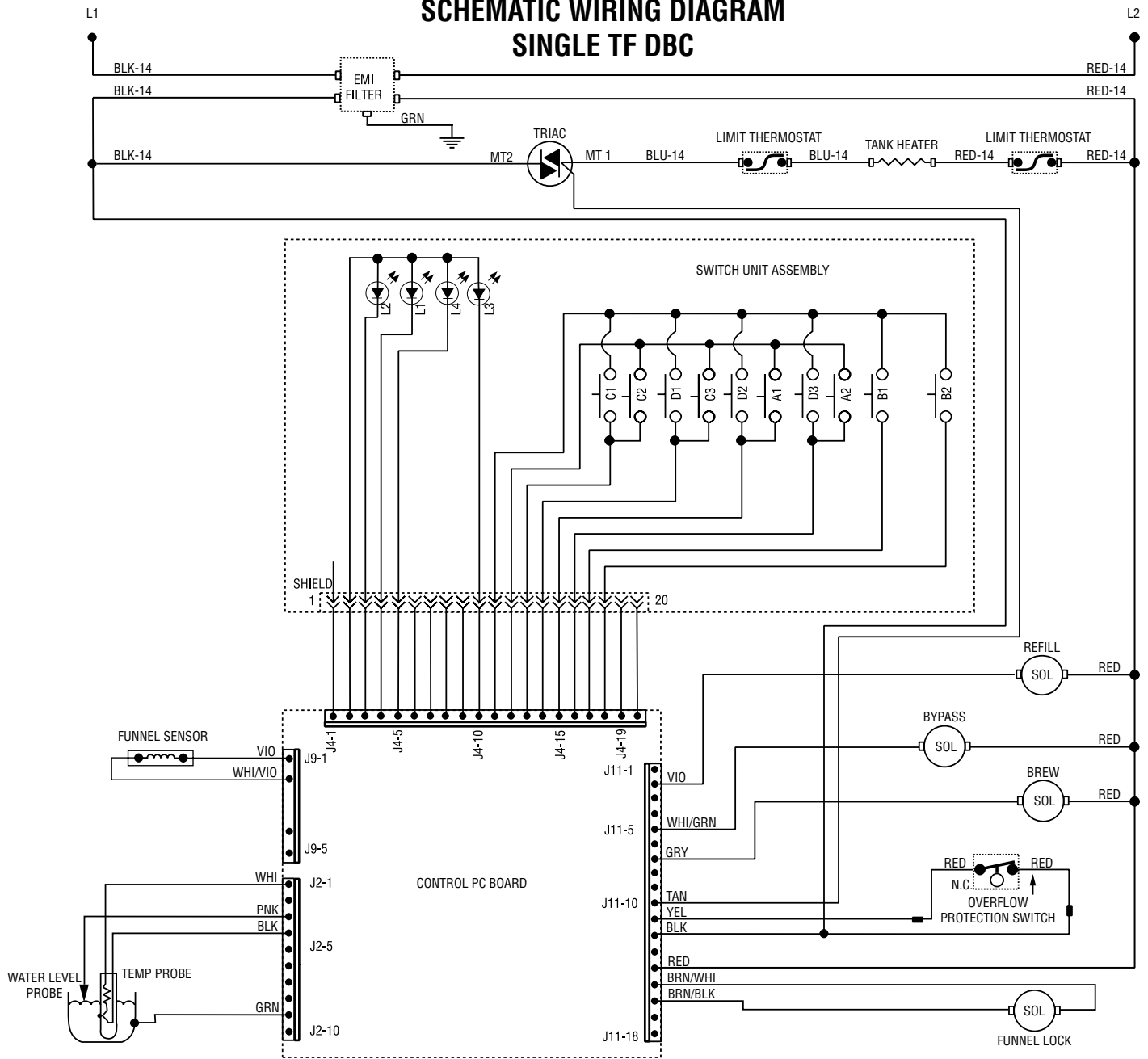

Switch Unit Assembly Codes			
A1	Brew	C2	Medium Batch
A2	On/Off	C3	Small Batch
B1	"Hidden" Left	D1	"Digital" Left Hidden Button
B2	"Hidden" Right	D2	"Brewer" Center Hidden Button
C1	Large Batch	D3	"Control" Right Hidden Button
LED's			
L1	Large Batch LED		
L2	Medium Batch LED		
L3	Small Batch LED		
L4	On/Off LED		

**230 OR 200
VOLT A.C.
SINGLE PHASE**

SCHEMATIC WIRING DIAGRAM SINGLE TF DBC

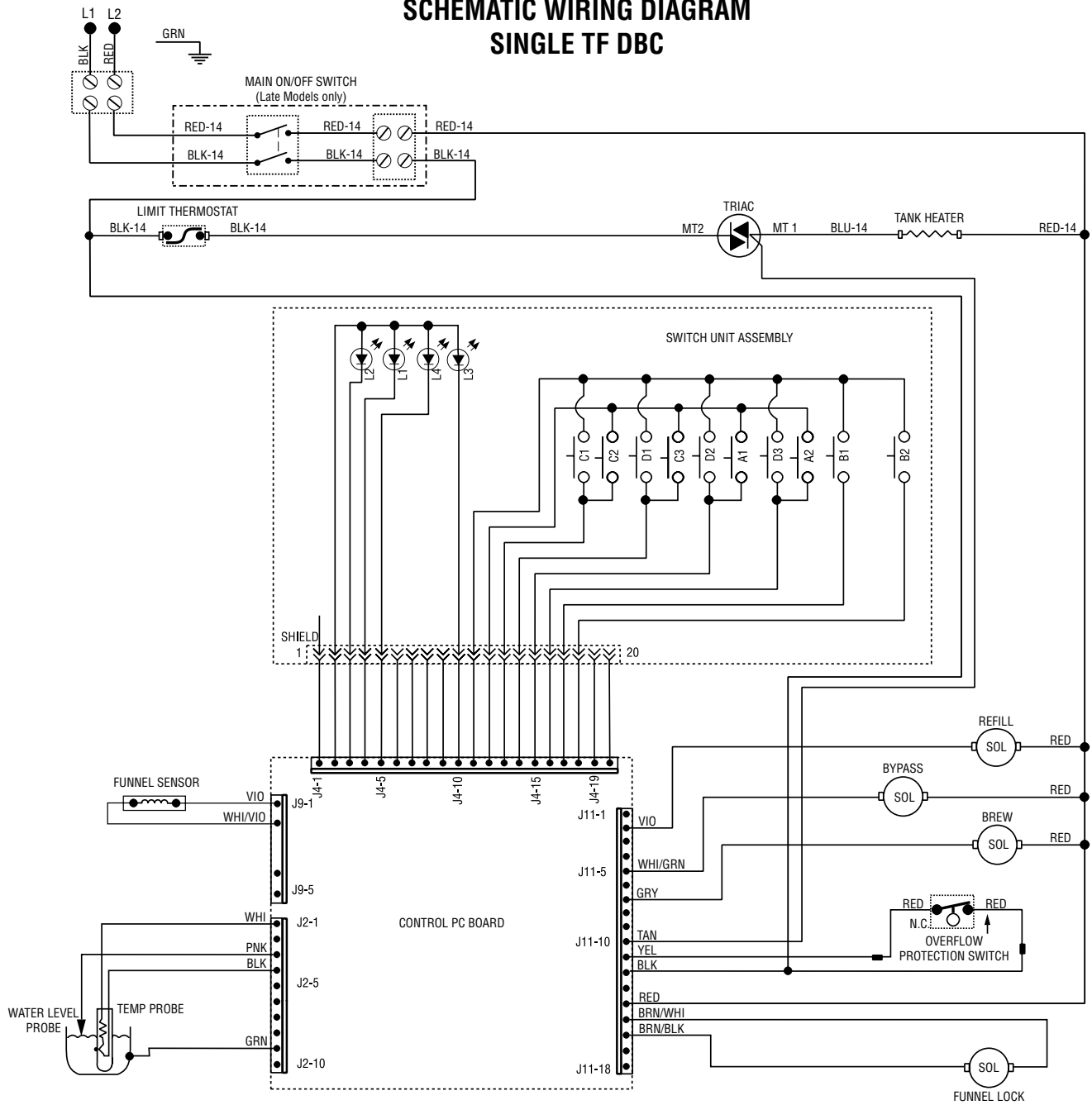

Switch Unit Assembly Codes			
A1	Brew	C2	Medium Batch
A2	On/Off	C3	Small Batch
B1	"Hidden" Left	D1	"Digital" Left Hidden Button
B2	"Hidden" Right	D2	"Brewer" Center Hidden Button
C1	Large Batch	D3	"Control" Right Hidden Button
LED's			
L1	Large Batch LED		
L2	Medium Batch LED		
L3	Small Batch LED		
L4	On/Off LED		

**200,208 or 240 VOLT A.C.
2 WIRE + GND
SINGLE PHASE 50/60HZ**

SCHEMATIC WIRING DIAGRAM SINGLE TF DBC, CE 3 PHASE W/NEUTRAL

Wire as shown for 3 phase. For single phase operation, move red wire in terminal block into cell with black wire; apply power across L1 & N.

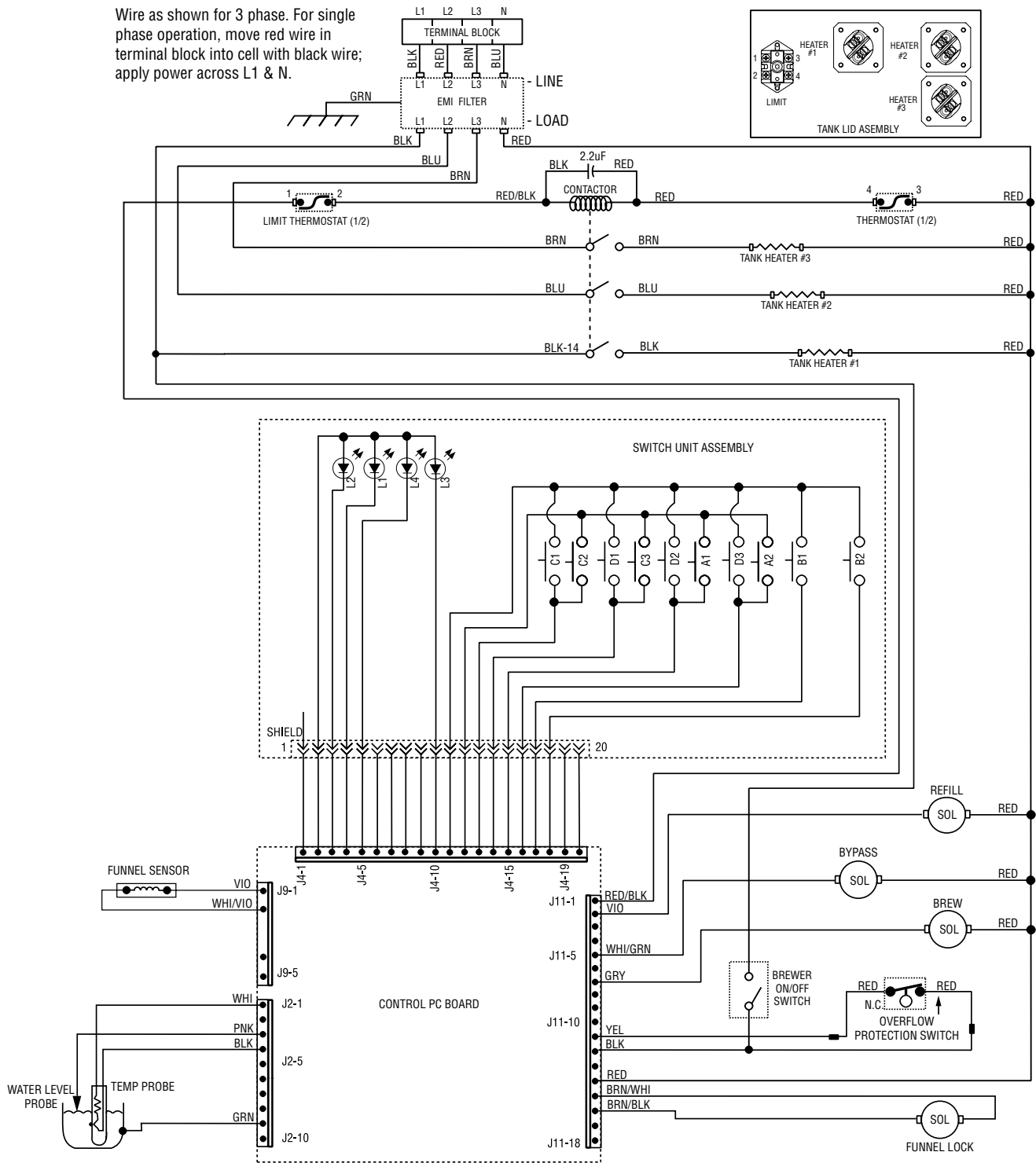

Switch Unit Assembly Codes			
A1	Brew	C2	Medium Batch
A2	On/Off	C3	Small Batch
B1	"Hidden" Left	D1	"Digital" Left Hidden Button
B2	"Hidden" Right	D2	"Brewer" Center Hidden Button
C1	Large Batch	D3	"Control" Right Hidden Button
LED's			
L1	Large Batch LED		
L2	Medium Batch LED		
L3	Small Batch LED		
L4	On/Off LED		

**400-415 VOLT A.C.
PHASE TO PHASE,
230 VOLTS AC
PHASE TO NEUTRAL
3 PHASE 50/60 HZ**

SCHEMATIC WIRING DIAGRAM SINGLE TF DBC-DV

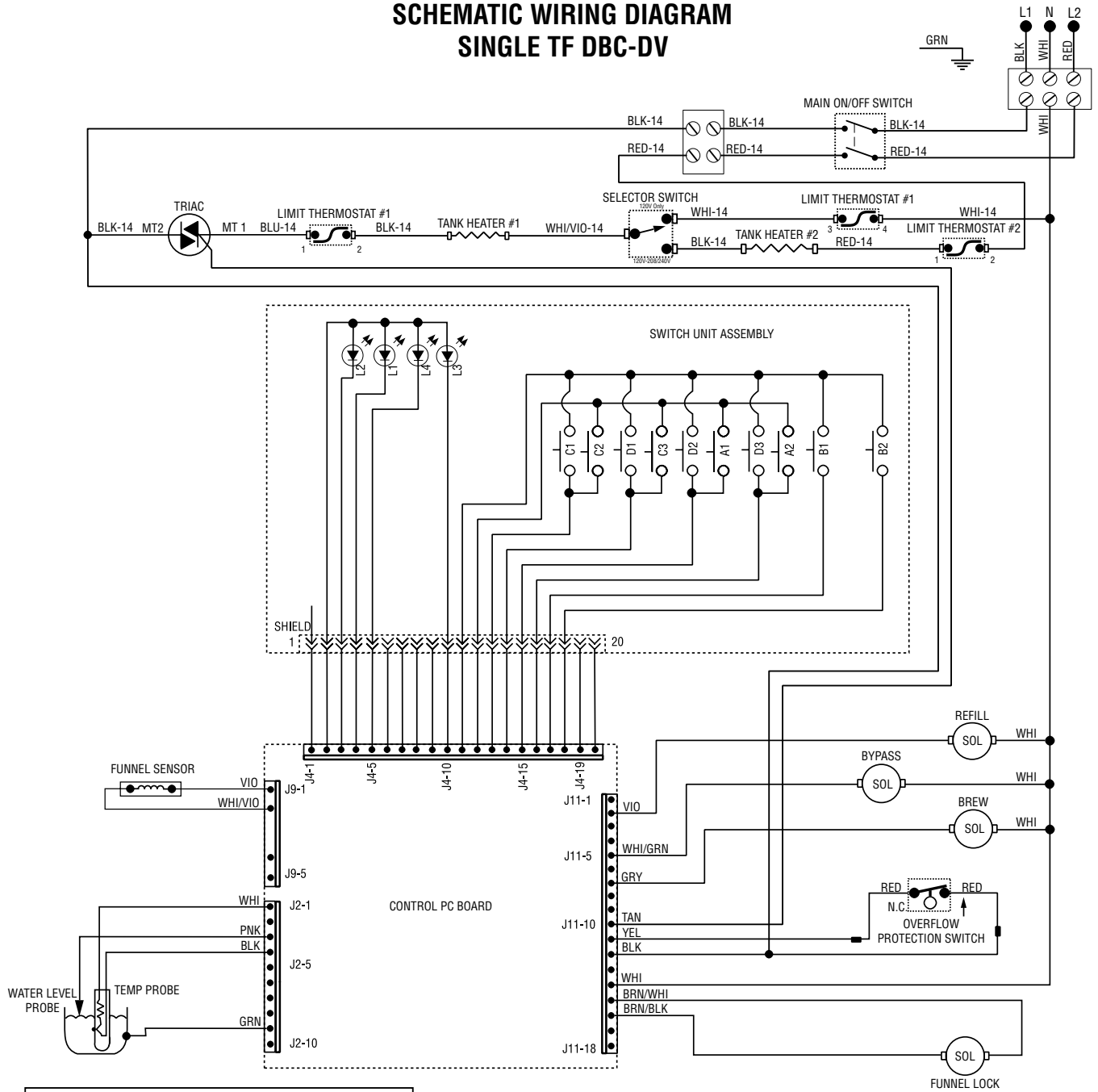

Switch Unit Assembly Codes			
A1	Brew	C2	Medium Batch
A2	On/Off	C3	Small Batch
B1	"Hidden" Left	D1	"Digital" Left Hidden Button
B2	"Hidden" Right	D2	"Brewer" Center Hidden Button
C1	Large Batch	D3	"Control" Right Hidden Button
LED's			
L1	Large Batch LED		
L2	Medium Batch LED		
L3	Small Batch LED		
L4	On/Off LED		

**120 VOLT A.C. + GND OR
120/208-240 VOLT A.C. + GND
SINGLE PHASE**

SCHEMATIC WIRING DIAGRAM DUAL TF DBC BREWWISE

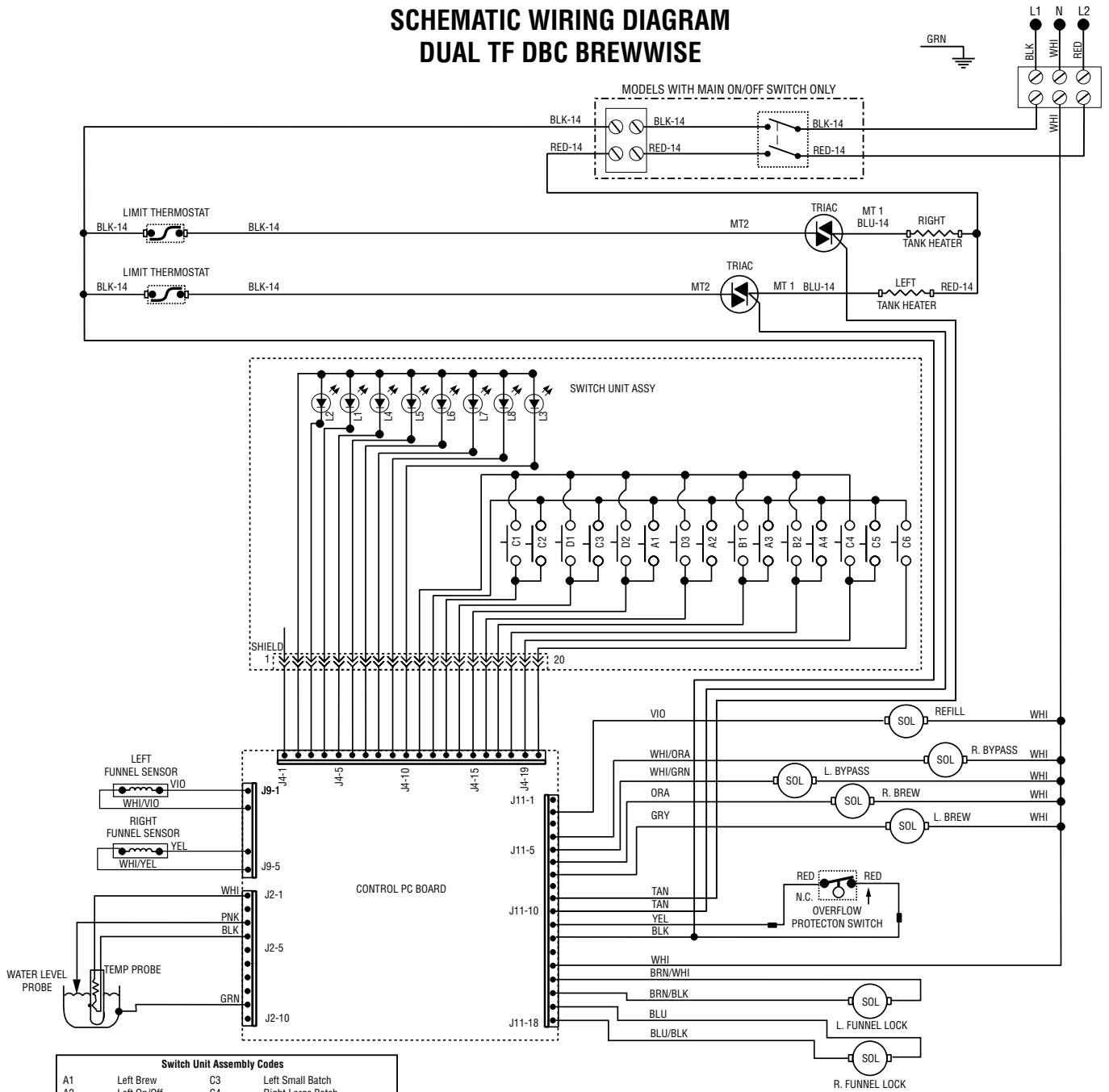

Switch Unit Assembly Codes			
A1	Left Brew	C3	Left Small Batch
A2	Left On/Off	C4	Right Large Batch
A3	Right On/Off	C5	Right Medium Batch
A4	Right Brew	C6	Right Small Batch
B1	"Hidden" Left	D1	"Digital" Left Hidden Button
B2	"Hidden" Right	D2	"Brewer" Center Hidden Button
C1	Left Large Batch	D3	"Control" Right Hidden Button
C2	Left Medium Batch		

LED's	
L1	Left Large Batch LED
L2	Left Medium Batch LED
L3	Left Small Batch LED
L4	Left On/Off LED
L5	Right On/Off LED
L6	Right Large Batch LED
L7	Right Medium Batch LED
L8	Right Small Batch LED

**120/208 OR 120/240 VOLT A.C.
3 WIRE + GND
SINGLE PHASE**

SCHEMATIC WIRING DIAGRAM DUAL TF DBC BREWWISE (With Faucet Tube Heater)

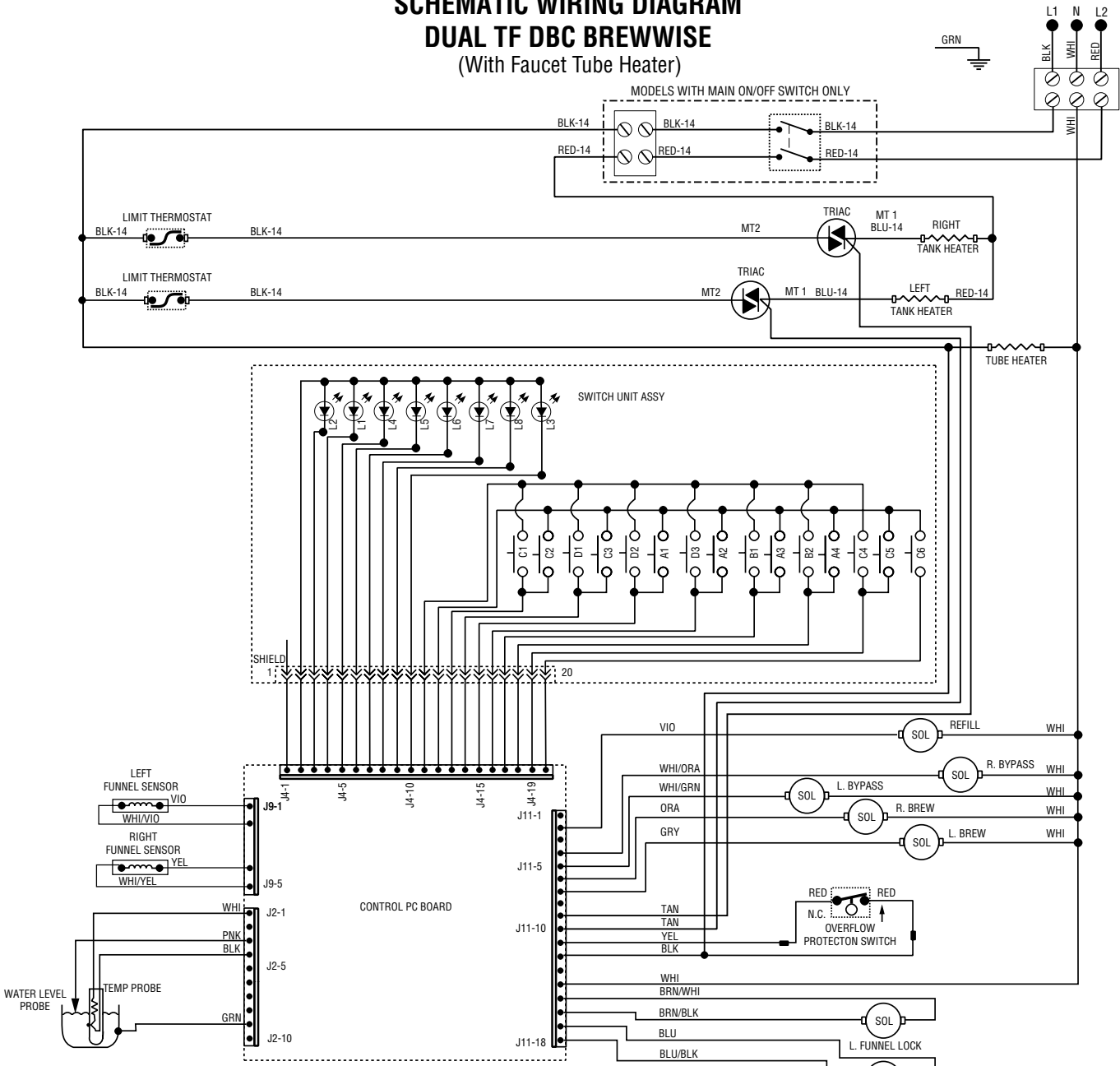

Switch Unit Assembly Codes			
A1	Left Brew	C3	Left Small Batch
A2	Left On/Off	C4	Right Large Batch
A3	Right On/Off	C5	Right Medium Batch
A4	Right Brew	C6	Right Small Batch
B1	"Hidden" Left	D1	"Digital" Left Hidden Button
B2	"Hidden" Right	D2	"Brewer" Center Hidden Button
C1	Left Large Batch	D3	"Control" Right Hidden Button
C2	Left Medium Batch		

LED's	
L1	Left Large Batch LED
L2	Left Medium Batch LED
L3	Left Small Batch LED
L4	Left On/Off LED
L5	Right On/Off LED
L6	Right Large Batch LED
L7	Right Medium Batch LED
L8	Right Small Batch LED

**120/208 OR 120/240 VOLT A.C.
3 WIRE + GND
SINGLE PHASE**

SCHEMATIC WIRING DIAGRAM DUAL TF DBC BREWWISE

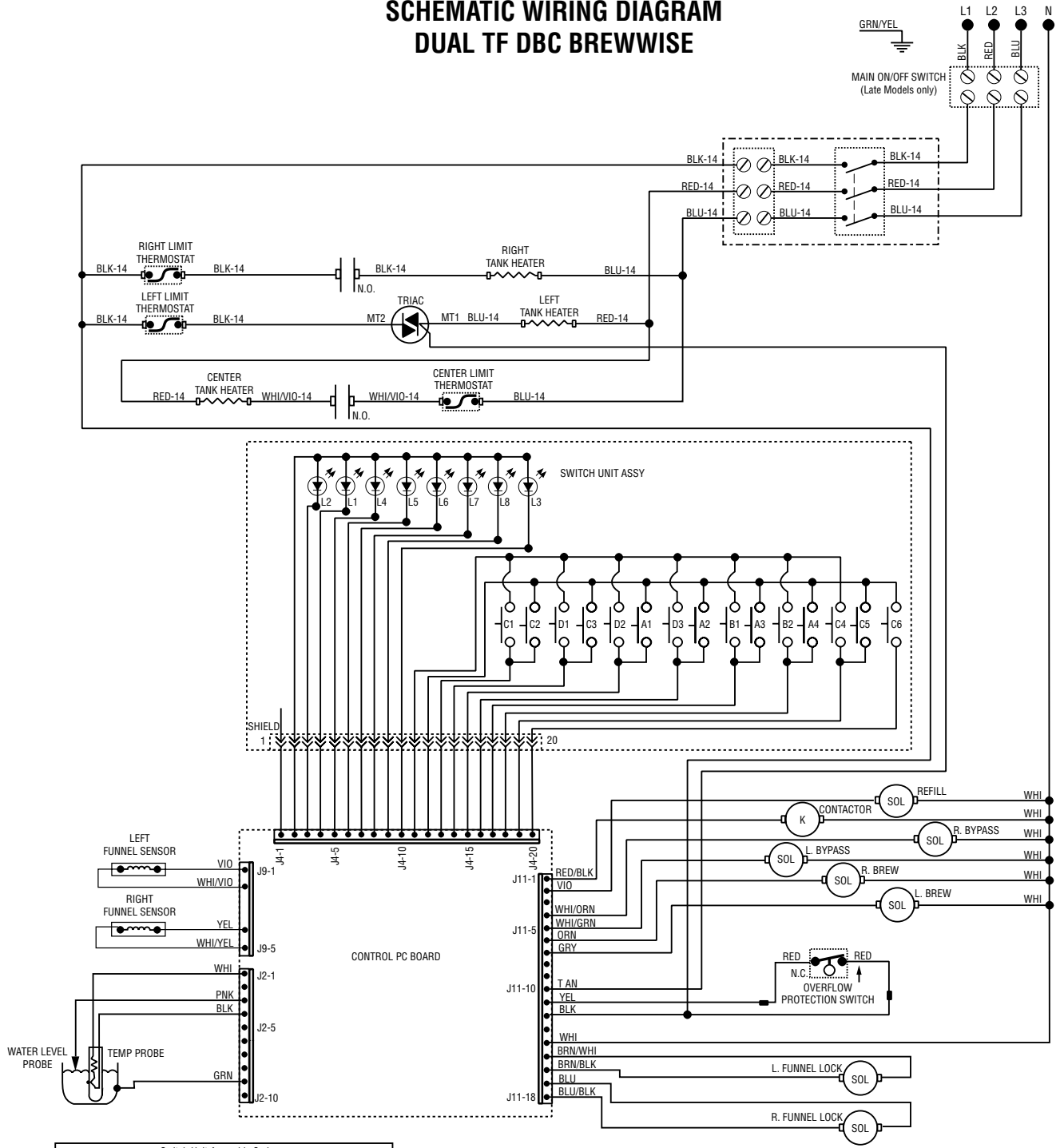

Switch Unit Assembly Codes			
A1	Left Brew	C3	Left Small Batch
A2	Left On/Off	C4	Right Large Batch
A3	Right On/Off	C5	Right Medium Batch
A4	Right Brew	C6	Right Small Batch
B1	"Hidden" Left	D1	"Digital" Left Hidden Button
B2	"Hidden" Right	D2	"Brewer" Center Hidden Button
C1	Left Large Batch	D3	"Control" Right Hidden Button
C2	Left Medium Batch		

LED's	
L1	Left Large Batch LED
L2	Left Medium Batch LED
L3	Left Small Batch LED
L4	Left On/Off LED
L5	Right On/Off LED
L6	Right Large Batch LED
L7	Right Medium Batch LED
L8	Right Small Batch LED

**120/208 OR 120/240 VOLT A.C.
4 WIRE + GND 3-PHASE**

SCHEMATIC WIRING DIAGRAM DUAL TF DBC BREWWISE

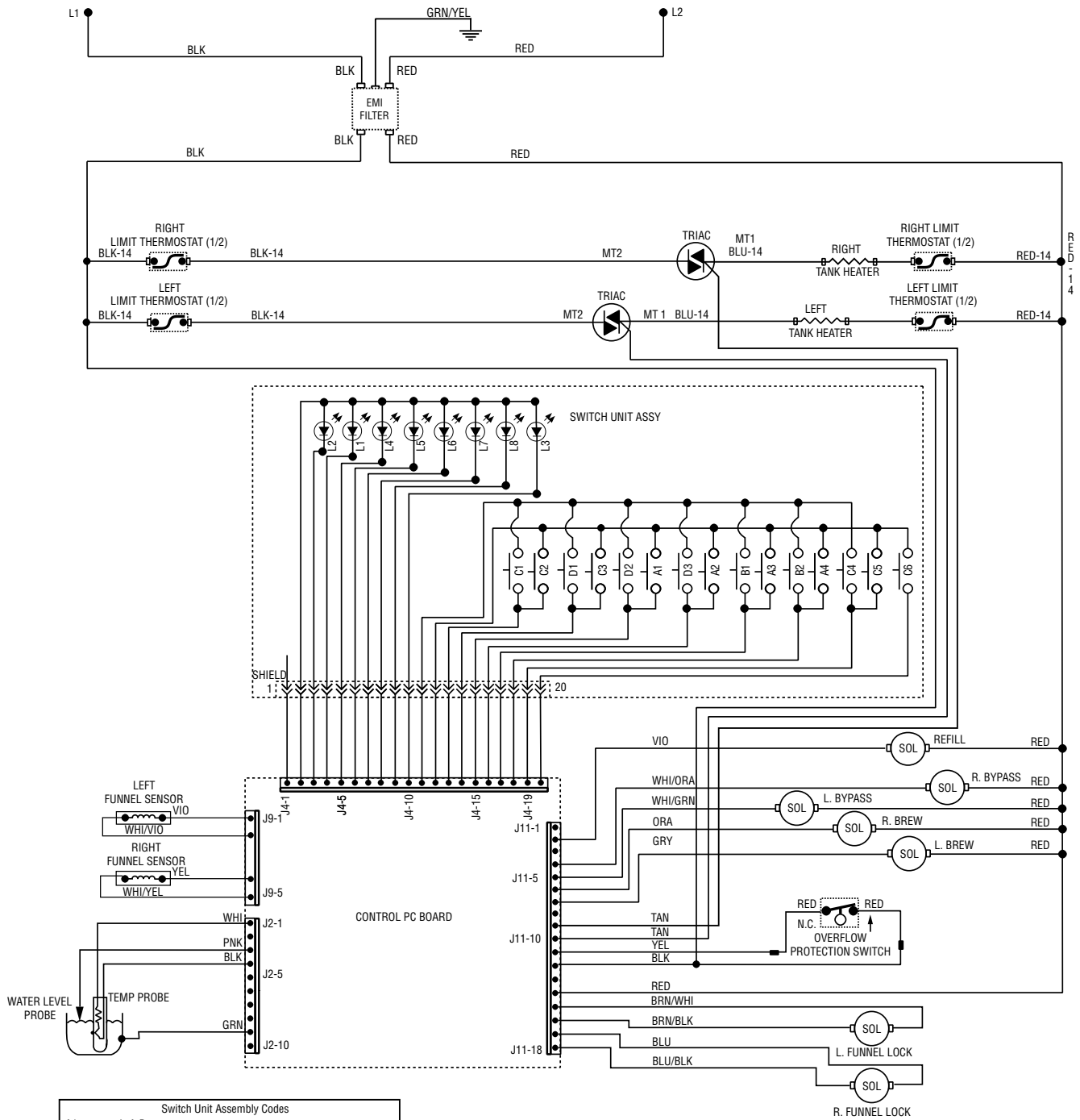

Switch Unit Assembly Codes			
A1	Left Brew	C3	Left Small Batch
A2	Left On/Off	C4	Right Large Batch
A3	Right On/Off	C5	Right Medium Batch
A4	Right Brew	C6	Right Small Batch
B1	"Hidden" Left	D1	"Digital" Left Hidden Button
B2	"Hidden" Right	D2	"Brewer" Center Hidden Button
C1	Left Large Batch	D3	"Control" Right Hidden Button
C2	Left Medium Batch		

LED's	
L1	Left Large Batch LED
L2	Left Medium Batch LED
L3	Left Small Batch LED
L4	Left On/Off LED
L5	Right On/Off LED
L6	Right Large Batch LED
L7	Right Medium Batch LED
L8	Right Small Batch LED

**200/230 VOLT A.C.
2 WIRE
SINGLE PHASE**

SCHEMATIC WIRING DIAGRAM DUAL TF DBC BREWWISE

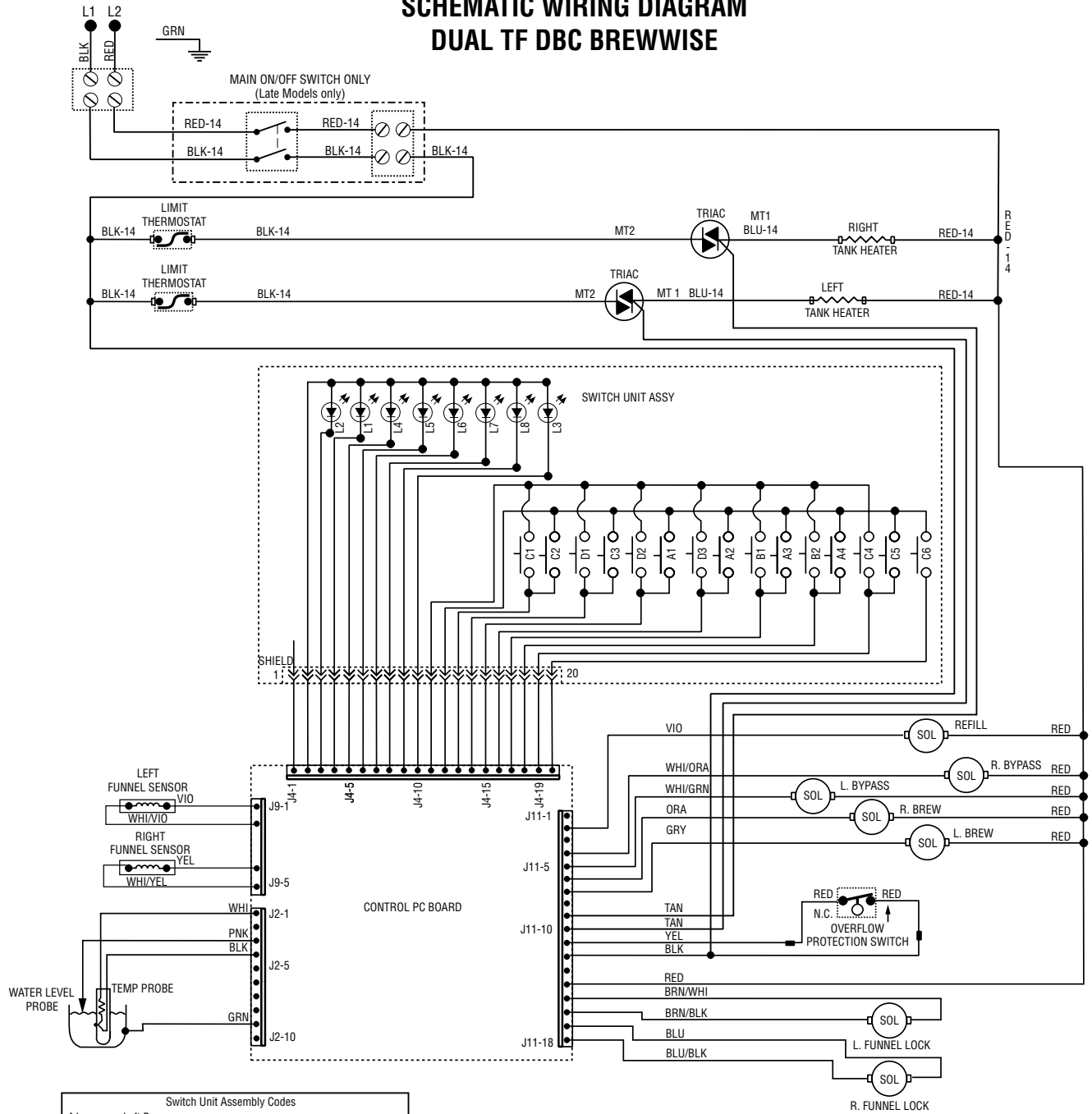

Switch Unit Assembly Codes			
A1	Left Brew	C3	Left Small Batch
A2	Left On/Off	C4	Right Large Batch
A3	Right On/Off	C5	Right Medium Batch
A4	Right Brew	C6	Right Small Batch
B1	"Hidden" Left	D1	"Digital" Left Hidden Button
B2	"Hidden" Right	D2	"Brewer" Center Hidden Button
C1	Left Large Batch	D3	"Control" Right Hidden Button
C2	Left Medium Batch		

LED's	
L1	Left Large Batch LED
L2	Left Medium Batch LED
L3	Left Small Batch LED
L4	Left On/Off LED
L5	Right On/Off LED
L6	Right Large Batch LED
L7	Right Medium Batch LED
L8	Right Small Batch LED

200,208 or 240 VOLT A.C.
2 WIRE + GND
SINGLE PHASE
50/60 HZ

SCHEMATIC WIRING DIAGRAM DUAL TF DBC, CE 3 PHASE W/NEUTRAL

Wire as shown for 3 phase. For single phase operation, move red wire in terminal block into cell with black wire; apply power across L1 & N.

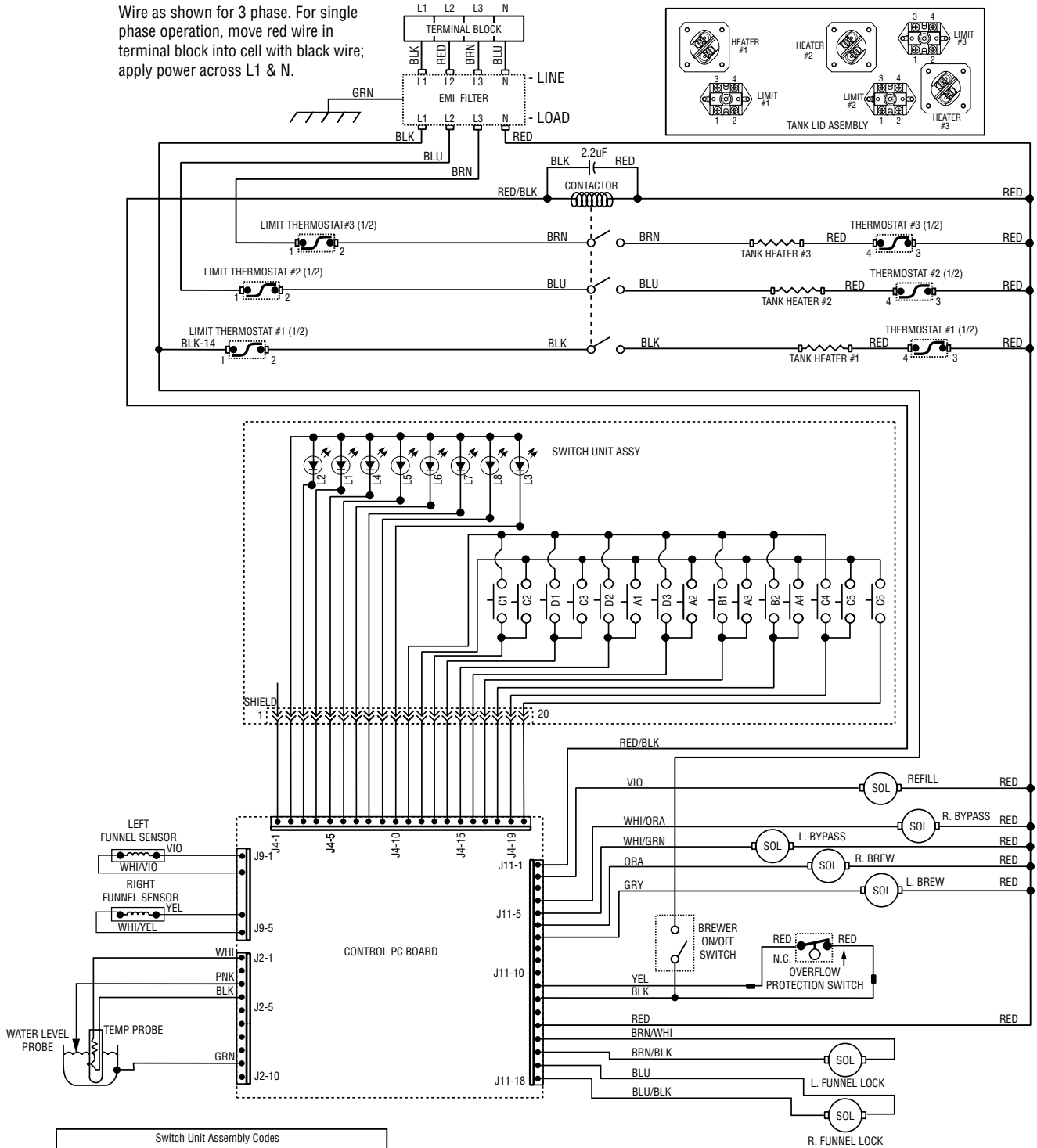

Switch Unit Assembly Codes			
A1	Left Brew	C3	Left Small Batch
A2	Left On/Off	C4	Right Large Batch
A3	Right On/Off	C5	Right Medium Batch
A4	Right Brew	C6	Right Small Batch
B1	"Hidden" Left	D1	"Digital" Left Hidden Button
B2	"Hidden" Right	D2	"Brewer" Center Hidden Button
C1	Left Large Batch	D3	"Control" Right Hidden Button
C2	Left Medium Batch		

LED's	
L1	Left Large Batch LED
L2	Left Medium Batch LED
L3	Left Small Batch LED
L4	Left On/Off LED
L5	Right On/Off LED
L6	Right Large Batch LED
L7	Right Medium Batch LED
L8	Right Small Batch LED

**400-415 VOLT A.C.
PHASE TO PHASE,
230 VOLTS AC
PHASE TO NEUTRAL
3 PHASE 50/60 HZ**

SCHEMATIC WIRING DIAGRAM DUAL TF DBC BREWWISE

• For 3 phase operation, wire as shown.
• For single phase operation, move BLU wire into cell with black wire; apply power across L1, L2 & N.

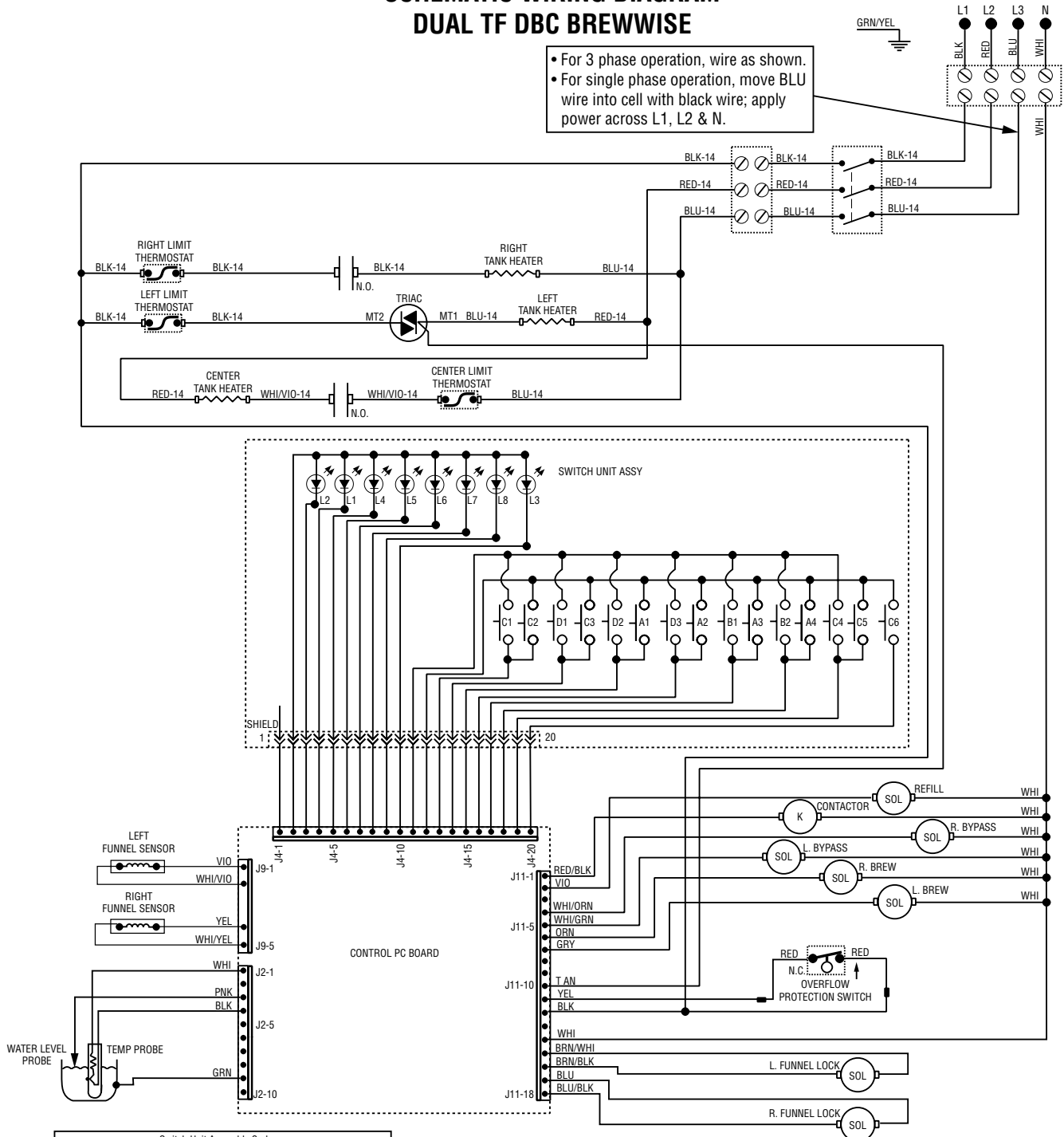

Switch Unit Assembly Codes			
A1	Left Brew	C3	Left Small Batch
A2	Left On/Off	C4	Right Large Batch
A3	Right On/Off	C5	Right Medium Batch
A4	Right Brew	C6	Right Small Batch
B1	"Hidden" Left	D1	"Digital" Left Hidden Button
B2	"Hidden" Right	D2	"Brewer" Center Hidden Button
C1	Left Large Batch	D3	"Control" Right Hidden Button
C2	Left Medium Batch		

LED's	
L1	Left Large Batch LED
L2	Left Medium Batch LED
L3	Left Small Batch LED
L4	Left On/Off LED
L5	Right On/Off LED
L6	Right Large Batch LED
L7	Right Medium Batch LED
L8	Right Small Batch LED

**120/208 OR 120/240 VOLT A.C.
4 WIRE + GND 3-PHASE or 1-PHASE**

SCHEMATIC WIRING DIAGRAM DUAL TF DBC BREWWISE

• For 3 phase operation, wire as shown.
• For single phase operation, move BLU wire into cell with black wire; apply power across L1, L2.

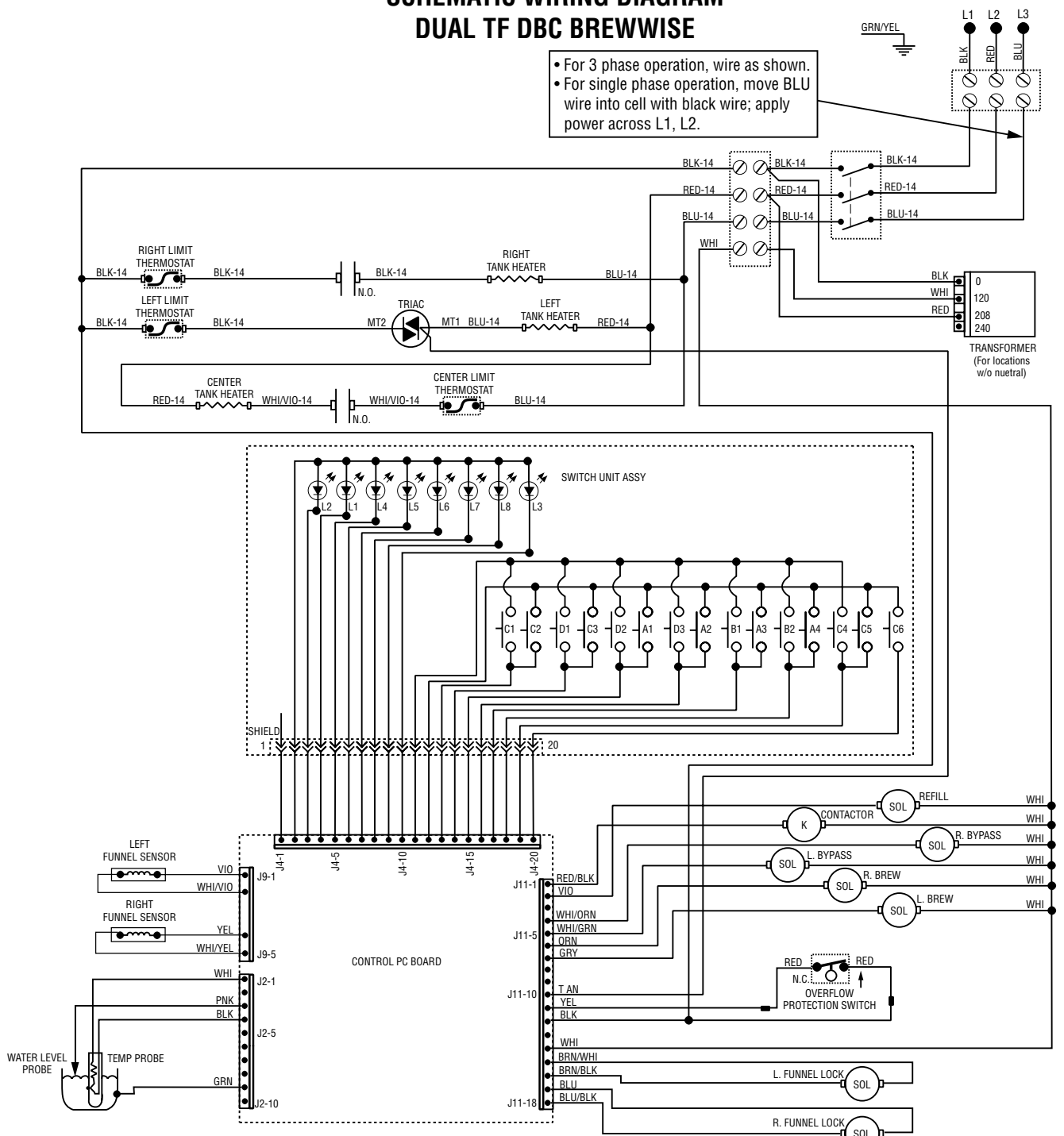

Switch Unit Assembly Codes			
A1	Left Brew	C3	Left Small Batch
A2	Left On/Off	C4	Right Large Batch
A3	Right On/Off	C5	Right Medium Batch
A4	Right Brew	C6	Right Small Batch
B1	"Hidden" Left	D1	"Digital" Left Hidden Button
B2	"Hidden" Right	D2	"Brewer" Center Hidden Button
C1	Left Large Batch	D3	"Control" Right Hidden Button
C2	Left Medium Batch		

LED's	
L1	Left Large Batch LED
L2	Left Medium Batch LED
L3	Left Small Batch LED
L4	Left On/Off LED
L5	Right On/Off LED
L6	Right Large Batch LED
L7	Right Medium Batch LED
L8	Right Small Batch LED

**208 OR 240 VOLT A.C.
3 WIRE + GND 3-PHASE or 1-PHASE**