

Gas Pressure Fryer

MODELS FKG-FC

Installation and Operation Manual

Serial Numbers 804000 and higher



BKI LIMITED WARRANTY

42 Allen Martin Drive, Essex Junction, VT 05452 • USA
(802) 658-6600 • Fax: (802) 862-0183

WHAT IS COVERED	<p>This warranty covers defects in material and workmanship under normal use, and applies only to the original purchaser providing that:</p> <ul style="list-style-type: none">• The equipment has not been accidentally or intentionally damaged, altered or misused;• The equipment is properly installed, adjusted, operated and maintained in accordance with national and local codes, and in accordance with the installation and operating instructions provided with this product.• The serial number rating plate affixed to the equipment has not been defaced or removed.
WHO IS COVERED	<p>This warranty is extended to the original purchaser and applies only to equipment purchased for use in the U.S.A.</p>
COVERAGE PERIOD	<ul style="list-style-type: none">• Warranty claims must be received in writing by BKI within one (1) year from date of installation or within one (1) year and three (3) months from date of shipment from the factory, whichever comes first.• Warranty period begins the date of dealer invoice to customer or ninety (90) days after shipment date from BKI, whichever comes first.
WARRANTY COVERAGE	<p>This warranty covers on-site labor, parts and reasonable travel time and travel expenses of the authorized service representative up to (100) miles round trip and (2) hours travel time and performed during regular, weekday business hours.</p>
EXCEPTIONS	<p>Any exceptions must be pre-approved in advance and in writing by BKI. The extended door warranty on convection ovens years 3 through 5 is a parts only warranty and does not include labor, travel, mileage or any other charges.</p>
EXCLUSIONS	<ul style="list-style-type: none">• Negligence or acts of God,• Thermostat calibrations after (30) days from equipment installation date,• Air and gas adjustments,• Light bulbs,• Glass doors and door adjustments,• Fuses,• Adjustments to burner flames and cleaning of pilot burners,• Tightening of screws or fasteners,• Failures caused by erratic voltages or gas suppliers,• Unauthorized repair by anyone other than a BKI Factory Authorized Service Center,• Damage in shipment,• Alteration, misuse or improper installation,• Thermostats and safety valves with broken capillary tubes,• Freight – other than normal UPS charges,• Ordinary wear and tear,• Failure to follow installation and/or operating instructions,• Events beyond control of the company.
INSTALLATION	<p>Leveling, as well as proper installation and check out of all new equipment - per appropriate installation and use materials – is the responsibility of the dealer or installer, not the manufacturer.</p>
REPLACEMENT PARTS	<p>BKI genuine Factory OEM parts receive a (90) day materials warranty effective from the date of installation by a BKI Factory Authorized Service Center.</p> <p>Warranty is in lieu of all other warranties, expressed or implied, and all other obligations or liabilities on the manufacturer's part. BKI shall in no event be liable for any special, indirect or consequential damages, or in any event for damages in excess of the purchase price of the unit. The repair or replacement of proven defective parts shall constitute a fulfillment of all obligations under the terms of this warranty.</p>

Table of Contents

Table of Contents	1
Introduction	2
Safety	2
Safety Signs and Messages	2
Specific Precautions	3
Equipotential ground plane	3
Full Disconnection	3
Safe Work Practices	5
Safety Labels	10
Installation	11
Unpacking and Handling	11
Preparation	11
Location and Clearance	12
Installation Procedure	12
Initial Test and Adjustment	14
Gas Conversion Instructions	14
Operation	15
Controls and Indicators	15
Care of the Shortening	18
FKG-FC Operation	19
System Programming	19
Product Programming	22
Start-Up (FKG-FC)	25
Cooking (FKG-FC)	26
Operation after Gas or Power Outage	28
Normal Shutoff	28
Maintenance	29
Scheduled Maintenance	29
Safety Pop Valve Procedure	30
Filtering Procedure	31
Boil-Out Procedure	32
Filter Pad Replacement	34
Troubleshooting	35
Notes	36

Introduction

The FKG Pressure Fryer is compact, attractive and functional in design. It is constructed of a stainless steel fryer pot for cleaning ease. Exclusive BKI patented features and safety devices offer flexibility, efficiency and reliability plus **PERFECTION IN PRESSURE FRYING!**

The BKI name and trademark on this unit assures you of the finest in design and engineering -- that it has been built with care and dedication -- using the best materials available. Attention to the operating instructions regarding proper installation, operation, and maintenance will result in long lasting dependability to insure the highest profitable return on your investment.

NOTICE

PLEASE READ THIS ENTIRE MANUAL BEFORE OPERATING THE UNIT. If you have any questions, please contact your BKI Distributor. If they are unable to answer your questions, contact the BKI Technical Service Department (802) 658-6600..

Safety

Always follow recommended safety precautions listed in this manual. Below is the safety alert symbol. When you see this symbol on your equipment, be alert to the potential for personal injury or property damage.



Safety Signs and Messages

The following Safety signs and messages are placed in this manual to provide instructions and identify specific areas where potential hazards exist and special precautions should be taken. Know and understand the meaning of these instructions, signs, and messages. Damage to the equipment, death or serious injury to you or other persons may result if these messages are not followed.



This message indicates an imminently hazardous situation which, if not avoided, will result in death or serious injury.



This message indicates a potentially hazardous situation, which, if not avoided, could result in death or serious injury.



This message indicates a potentially hazardous situation, which, if not avoided, may result in minor or moderate injury. It may also be used to alert against unsafe practices.



This message is used when special information, instructions or identification are required relating to procedures, equipment, tools, capacities and other special data.

Specific Precautions



Risk of fire exists if the oil level drops below 5mm of the maximum oil level.



Use of oil/shortening older than the manufacturer's recommendations for life of the oil is prone to surge boiling and flash fires. Follow the oil manufacturer's guidelines for the life cycle of oil/shortening.



Do not open the drain valve or the fill valve while the fryer is under pressure. Serious burns may result.



The appliance and its individual shutoff valve must be disconnected from the gas supply system during any pressure testing of that system at test pressures in excess of ½ psi (3.5 kPa).



FOR YOUR SAFETY

Do not store or use gasoline or other flammable vapors or liquids in the vicinity of this or any other appliance.



Improper installation, adjustment, alteration, service or maintenance can cause property damage, injury or death. Read the installation, operation and maintenance instructions thoroughly before installing or servicing this equipment.



California Residents Only. This product can expose you to chemicals including chromium, and lead which are known to the State of California to cause cancer and birth defects or other reproductive harm. For more information go to www.P65Warnings.ca.gov.



Follow instructions regarding effects of surge boiling of over-wet foods and proper load size.



Equipotential ground plane

When a high current flows through a conductor, differences in potential appear between the conductor and nearby metallic surfaces near the appliance. As a result, sparks may be produced between the appliance and surrounding metal surfaces. These sparks could cause serious injury, damage, or fire.

BKI provides an Equipotential ground terminal for the connection of a bonding conductor after the installation of the appliance per IEC60417-1. This terminal is located on the inside of the Power Entry Supply box near the Earth connection and is marked with this symbol.



Full Disconnection

In accordance with Local and/or National wiring codes, the installer must provide a means of full disconnection under over voltage Category III conditions. An IEC approved cord and plug combination will meet this requirement.

Units not provided with a cord and plug do not meet this requirement. In accordance with Local and/or National wiring codes, the installer must provide the means of full disconnection.

NOTICE

The fryer is designed to hold a maximum of 75lbs (34KG) of oil/shortening.

NOTICE

The purchaser must post, in a prominent location, instructions to be followed in the event the user smells gas. This information shall be obtained by consulting the local gas supplier.

Safe Work Practices



Do Not Store or Use Anything Flammable Near The Fryer

Your pressure fryer is powered by either natural gas or LP gas. Do not store or use gasoline or any flammable liquids or vapors near this or any other appliance. Flammable materials will burn easily. Letting any flammable liquid or vapor get too close to the fryer could cause an explosion or fire. Serious injury could result. Examples of flammables that you should not store near the fryer are gasoline, paint, thinners or removers, gas tanks, and cleaning materials.



Use Gas Safely-- Avoid Danger

Gas can be a dangerous fuel if not handled safely.

Make sure to ventilate the fryer properly. If the fryer is not properly ventilated, carbon monoxide can be released around the fryer. Asphyxiation or suffocation can occur if gas is not ventilated properly.

Before using this appliance for the first time, contact your local gas supplier for instructions about what to do if you smell gas. Post those instructions somewhere near the fryer, so that everyone who uses or works near the fryer knows what to do if they smell gas.



Beware of High Voltage

This equipment uses high voltage. Serious injury can occur if you or any untrained or unauthorized person installs, services, or repairs this equipment. Always Use an Authorized Service agent to Service Your Equipment.



Use the Fryer on Noncombustible Floors Only

Make sure your floor is noncombustible. Do not operate your fryer on floors that are wood, carpeted or have rubber mats. Placing your fryer on a combustible floor could cause a fire. Serious injury could result. Examples of noncombustible floors where you can safely place your fryer are concrete, tile, and ceramic.

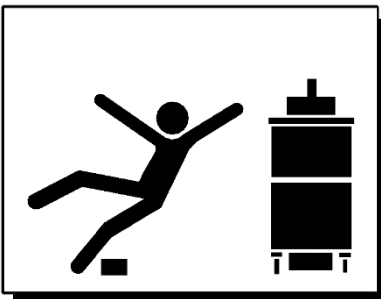

Keep the Area Around Your Fryer Uncluttered

Make sure to keep the area around your fryer clear of any obstacles. Serious injury can occur if you trip or fall near the fryer. You could be burned by hot shortening that splashes out of the fryer or by falling against the hot metal of the fryer.



Keep the Floor Around Your Fryer Clean Of Shortening

Make sure to keep the floor around your fryer clean of shortening and other liquids. Serious injury can occur if you slip near your fryer. You could be burned by hot shortening that splashes out of the fryer or by falling against the hot metal of the fryer.

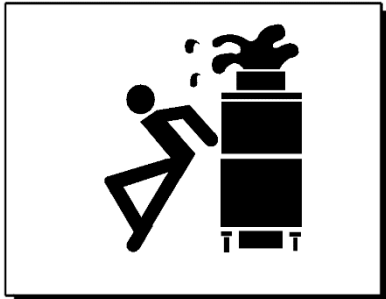

Keep the Lid Closed When The Fryer Is Not In Use

Hot shortening can splash if someone moves the fryer or bumps into it. Serious injury can occur if hot shortening splashes out of the fryer.

Do not lean, sit or stand on the fryer or perform any maintenance or cleaning duties while the fryer or the shortening is hot. You could be burned.

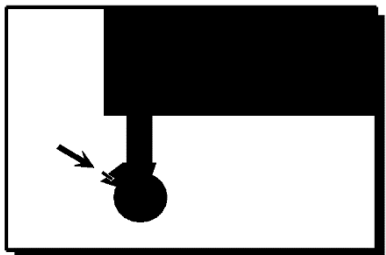

Keep the Casters Locked

To avoid spilling shortening, keep the casters locked. If any shortening spills near your fryer, clean it up immediately.

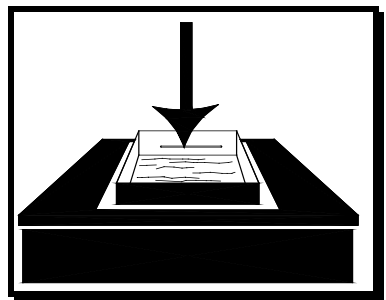

Do Not Overfill the Fryer with Shortening

Hot shortening and steam may escape and burn you if you put too much shortening in the fryer. Fill the fryer to the fill marks that are inside the fryer pot. Heat the shortening.

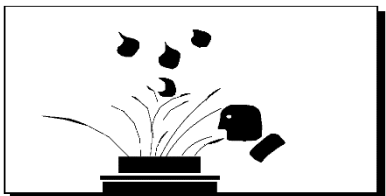

Do Not Let Any Water Get into The Fryer

Always remove excess moisture from food before placing it into the fryer basket. Water will cause the hot shortening to spatter. You could be burned.



Do Not Overload the Basket With Food

Hot shortening and steam may escape and burn you if you place too much food in the basket.

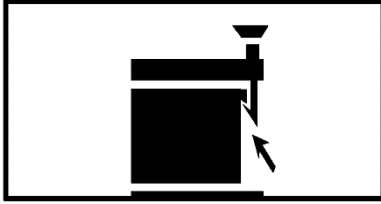

Always Make Sure the Lid Hook Is Latched When Closing The Fryer

To make sure the lid hook is latched properly, press down the lid until the hook snaps shut. Hot shortening and steam can escape if the lid hook is not latched properly. You could be burned.

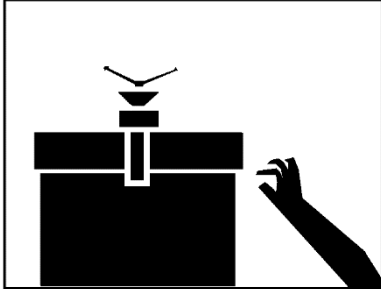

Always Tighten the Spin Handle When Closing The Fryer

Hot shortening and steam can escape if you do not tighten the spin handle properly. You could be burned. Line up the orange knobs on the fryer lid handle and the front hook when tightening.

Do Not Over-Tighten the Spin Handle

You could damage the fryer.

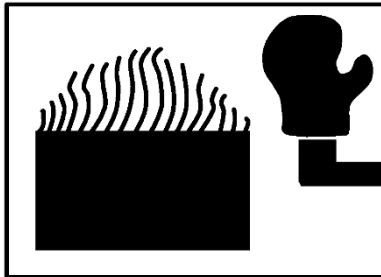

Wear Safe Clothing Appropriate To Your Job

Always wear your insulated mitts when handling the fryer basket or touch any hot metal surfaces. You received a pair of insulated mitts with your fryer. If you lose or damage your mitts, you can buy new ones at your local restaurant equipment supply store or from your local **BKI** Distributor.

Always wear non-skid shoes when working around the fryer or any other equipment that uses shortening. Never wear loose clothing such as neckties or scarves while operating your fryer. Keep loose hair tied back or in a hair net while operating your fryer.

Always wear appropriate personal protection equipment during the filtering process to guard against possible injury from hot oil.

Always wear appropriate personal protection equipment during the boil-out process to guard against possible injury from hot cleaning solution.

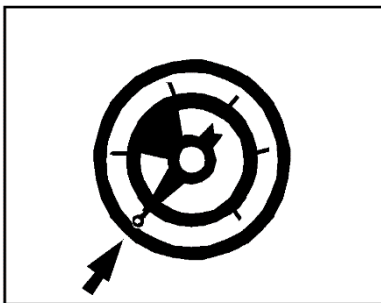

Never Loosen the Spin Handle Until The Pressure Gauge Is At Zero

Steam may escape suddenly if you loosen the spin handle before the gauge is at zero. If steam escapes suddenly, you could be burned.

After the pressure gauge is at zero, wait 5 seconds. Then loosen the spin handle slowly to open the lid of the fryer. By doing this, the steam will escape slowly and you will not be burned.

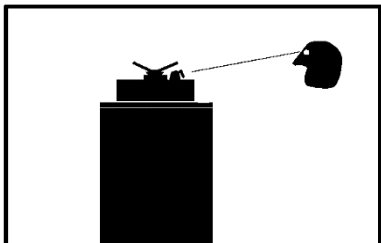

Seal the Safety Valve Properly

To seal the safety valve, lift the arm on the side of the valve. Then release it. The valve should snap closed. Hot steam can escape from the valve and you could be burned if you do not seal the valve properly.

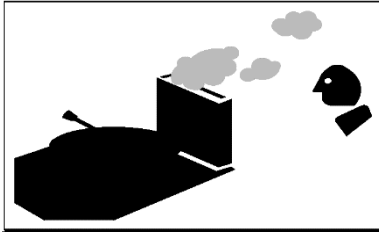

Keep Away From the Vent

Hot steam escapes from the vent continuously when you are using your fryer. You could be burned if you get too close to the vent.

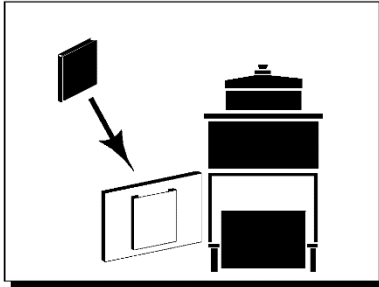

Keep this manual with the Equipment

This manual is an important part of your equipment. Always keep it near for easy access.

If you need to replace this manual, contact:

BKI

Technical Services Department
42 Allen Martin Drive
Essex Junction, VT 05452
(802) 658-6600



Protect Children

Keep children away from this equipment. Children may not understand that this equipment is dangerous for them and others.

NEVER allow children to play near or operate your equipment.

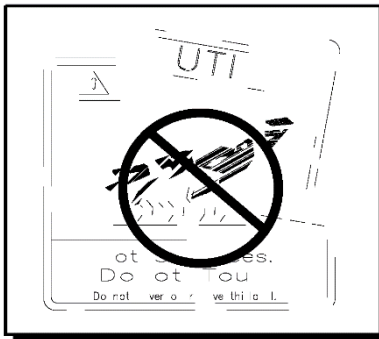

Keep Safety Labels Clean and in Good Condition

Do not remove or cover any safety labels on your equipment. Keep all safety labels clean and in good condition. Replace any damaged or missing safety labels. Refer to the Safety Labels section for illustration and location of safety labels on this unit.

If you need a new safety label, obtain the number of the specific label illustrated on page 10, then contact:

BKI

Technical Services Department
42 Allen Martin Drive
Essex Junction, VT 05452
(802) 658-6600

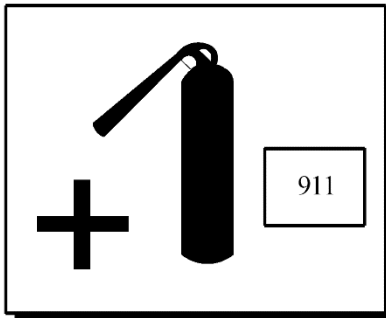

Be Prepared for Emergencies

Be prepared for fires, injuries, or other emergencies.

Keep a first aid kit and a fire extinguisher near the equipment. You must use a 40-pound Type BC fire extinguisher and keep it within 25 feet of your equipment.

Keep emergency numbers for doctors, ambulance services, hospitals, and the fire department near your telephone.

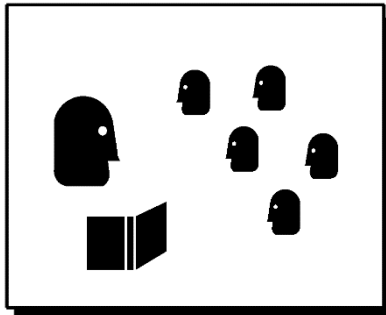

Know your responsibilities as an Employer

- Make certain your employees know how to operate the equipment.
- Make certain your employees are aware of the safety precautions on the equipment and in this manual.
- Make certain that you have thoroughly trained your employees about operating the equipment safely.
- Make certain the equipment is in proper working condition. If you make unauthorized modifications to the equipment, you will reduce the function and safety of the equipment.

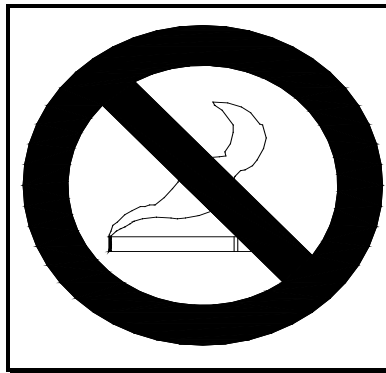

Do Not Smoke Near The Fryer.



Electrical Grounding Instructions:

This appliance is equipped with a three-prong (grounding) plug for your protection against shock hazard and should be plugged directly into a properly grounded three-prong receptacle. Do not cut or remove the grounding prong from this plug.

Safety Labels

N0170

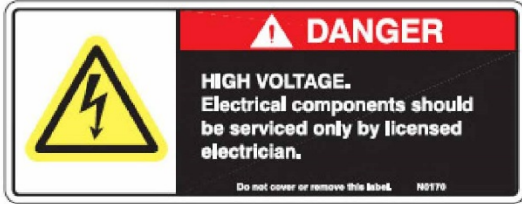

N0202



N0059

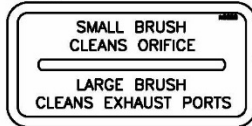

N0168



N0165



N0395

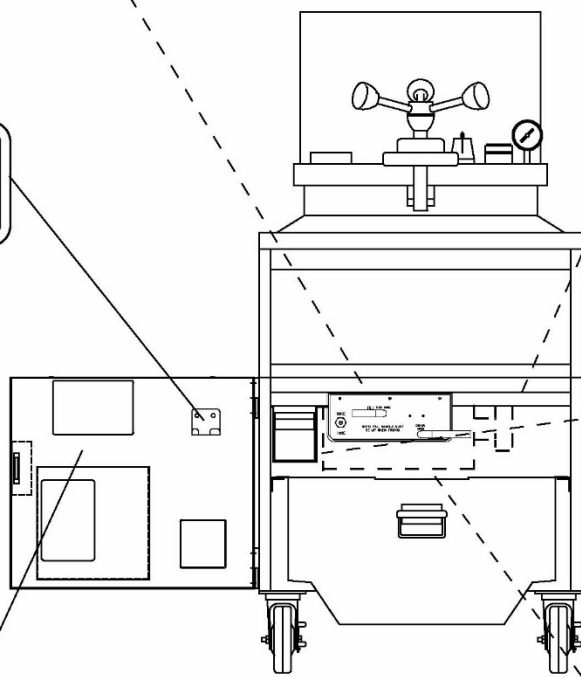

Installation

Unpacking and Handling

It is the owners' responsibility to file all freight claims with the delivering truck line. Inspect all cartons and crates for damage as soon as they arrive. If damage to cartons or crates is found, or if a shortage is found, note this on the bill of lading (all copies) prior to signing.

If damage is found when the equipment is opened, immediately call the delivering truck line and follow up the call with a written report indicating concealed damage to your shipment. Ask for an immediate inspection of your concealed damage item. Packaging material **MUST** be retained to show the inspector from the truck line.

Preparation

There are several things the installer must know before installing the fryer. These are listed below:

- The fryer installation must conform with city or county standards for gas appliances and gas piping. If your area does not have local codes, consult the *National Fuel Gas Code, ANSI Z223.1/NFPA 54*, or the *Natural Gas and Propane Installation Code, CSA B149.1*.

WARNING

Do not attempt to test the gas pressure of your fryer. Pressure testing should be done only by an authorized Service Agent.

- During any pressure testing of the gas supply system, the fryer must be protected. The fryer and its individual shutoff valve must be disconnected from the gas supply piping system during any pressure testing of that system at test pressures in excess of ½ psi (3.5 kPa). The fryer must be isolated from the gas supply piping system by closing its individual manual shutoff valve during any pressure testing of the gas supply piping system at test pressures equal to or less than ½ psi (3.5 kPa).
- The fryer must be electrically grounded to conform with the local code of your city or county. If your area does not have local codes, consult the latest version of the *National Electrical Code ANSI/NFPA 70*, or the *Canadian Electrical Code, CSA C22.2*.
- A schematic diagram of the unit is glued to the back of either the left or right side panel.
- The Authorized Service Agent that installs your fryer must connect the cord set at the rear of the fryer to an electrical source with a voltage matching that stamped on the name and rating tag. Refer to the wiring diagrams in this manual.
- Make sure a connector is used that complies with the Standard for *Connectors for Movable Gas Appliances, ANSI Z21.69 • CSA 6.16*.
- Make sure a quick-disconnect device is used that complies with the Standard for *Quick-Disconnect Devices for Use With Gas Fuel, ANSI Z21.41 • CSA 6.9*.
- Make sure a restraining device is used that complies with the Standard for *Commercial Gas Ranges, ANSI Z83.11/CGA 1.8* (such as BKI part number [FT0279](#)) to guard against transmission of strain to the connector.
- Retain the manual for future reference.

Location and Clearance

Install your fryer in a well-ventilated area. This will ensure that the gas burns properly and will help prevent any fires. When deciding on a location for your fryer, remember the following:

- All gas-burning appliances need enough fresh air for combustion.
- Locate the fryer where it can be vented into an adequate exhaust hood. Your local gas utility must approve your ventilation system. Consult a ventilation or heating company to help you design an adequate system that meets ventilation codes and standards for your city or county.
- Keep the fryer away from any combustibles such as curtains, wood paneling, boxes, or towels. The flue riser at the rear of the fryer should also be kept away from any flammable material.
- Use this fryer on non-combustible flooring only. Examples of non-combustible floors where you can safely locate your fryer are concrete, tile, and ceramic. Minimum clearance from combustible and non-combustible construction is 0 inches from the sides and 6 inches from the flue riser at the rear. **DO NOT** locate your fryer on floors that are wood, have rubber mats, or, are carpeted.
- Keep the work area around the fryer free of objects that might block fresh air or that might cause a fire.
- Do not attach an extension to the exhaust stack. This may stop the burner from operating properly, cause the burner to go off, or, cause other dangerous malfunctions. It may also cause a strong draft in the room. A draft can interfere with the burner.
- Do not locate the fryer near strong drafts. Keep the fryer away from doors that are opened and closed frequently.

Installation Procedure

1. Remove the shipping packing materials from the interior and exterior of the fryer.



WARNING

Ensure that an authorized BKI service agent installs the fryer. An authorized BKI service agent should be a qualified gas service technician and a licensed electrician.

2. Remove the shipping packing clip from underneath the dead weight cap.

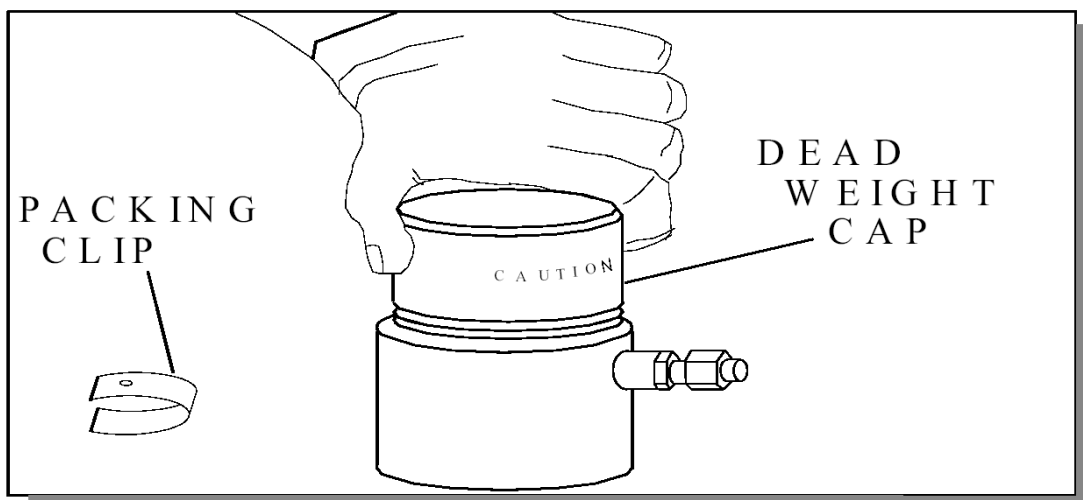

3. Replace the dead weight and cover.



Failure to restrain the fryer could allow it to move, causing hot shortening to spill out, or a possible break in the gas line causing an explosive condition.

4. Install an ANSI Z83.11/CGA 1.8 compliant restraining device (such as BKI part number [FT0279](#)) per the instructions below:
 - Mount the wall attachment according the restraining device manufacturer instructions.
 - Attach the spring-loaded hook on the restraining device to the eye-bolt mounted to the fryer then attach the other spring-loaded hook to the wall attachment.



Use appliance connectors and quick-disconnect devices that are in compliance with the applicable ANSI and CSA standards.

5. Connect the gas supply to the fryer
6. Lock the casters so the fryer does not move. Every time you use the fryer, make sure the casters are locked so the fryer cannot move. (In Canada: refer to caster codes CAN 1-6.10 M88 and CAN 1-6.9 M79.)
7. Turn on the gas at the gas supply valve.
8. Check for gas leaks from the gas supply to the fryer gas valve using a soap and water solution. If a leak is detected, tighten the connection where the leak occurs.
9. Apply power to the fryer.
10. Clean the fryer pot before filling with shortening. See boil out procedure.
11. Place the DRAIN handle in the CLOSED position.

Initial Test and Adjustment

1. Turn on the gas at the gas supply valve.
2. Place the DRAIN handle in the CLOSED position.
3. Fill pot with shortening to about one inch below the mark.

WARNING

Risk of fire exists if the oil level drops below the minimum oil level. The level of oil within the pot must not fall below 5mm of the maximum oil level.

WARNING

Use of oil/shortening older than the manufacturers recommendations for life of the oil is prone to surge boiling and flash fires. Follow the oil manufacturers guidelines for lifecycle of oil/shortening.

CAUTION

Overfilling the fryer pot with shortening could lead to serious injury. Ensure that the fryer pot is filled with shortening only to the fill mark when shortening is hot. Do not use any shortening other than what is specified in this manual and do not overfill the fryer pot.

CAUTION

The fryer has a maximum temperature setting of 375° F/191° C. Do not use oil/shortening with a flashpoint less than 554° F (290° C)

NOTICE

Use only high-quality shortening that has low moisture content, a high smoke point and no additives.



4. Before you turn on the gas, wait at least five minutes to allow any gas that may have accumulated in the burner compartment to escape.
5. Place the **FILTER/OFF/FRY** switch to the **FRY** position. The shortening should begin to heat and begin to reach the fill mark inside the pot. Add more shortening as required to reach the fill mark.

Gas Conversion Instructions

To convert the gas system from a Natural Gas to LP Gas application or vice versa, contact the BKI Technical Service Department, (802) 658-6600.

Operation

Controls and Indicators

Refer to the figure and table below for an explanation of the fryer's controls and indicators.

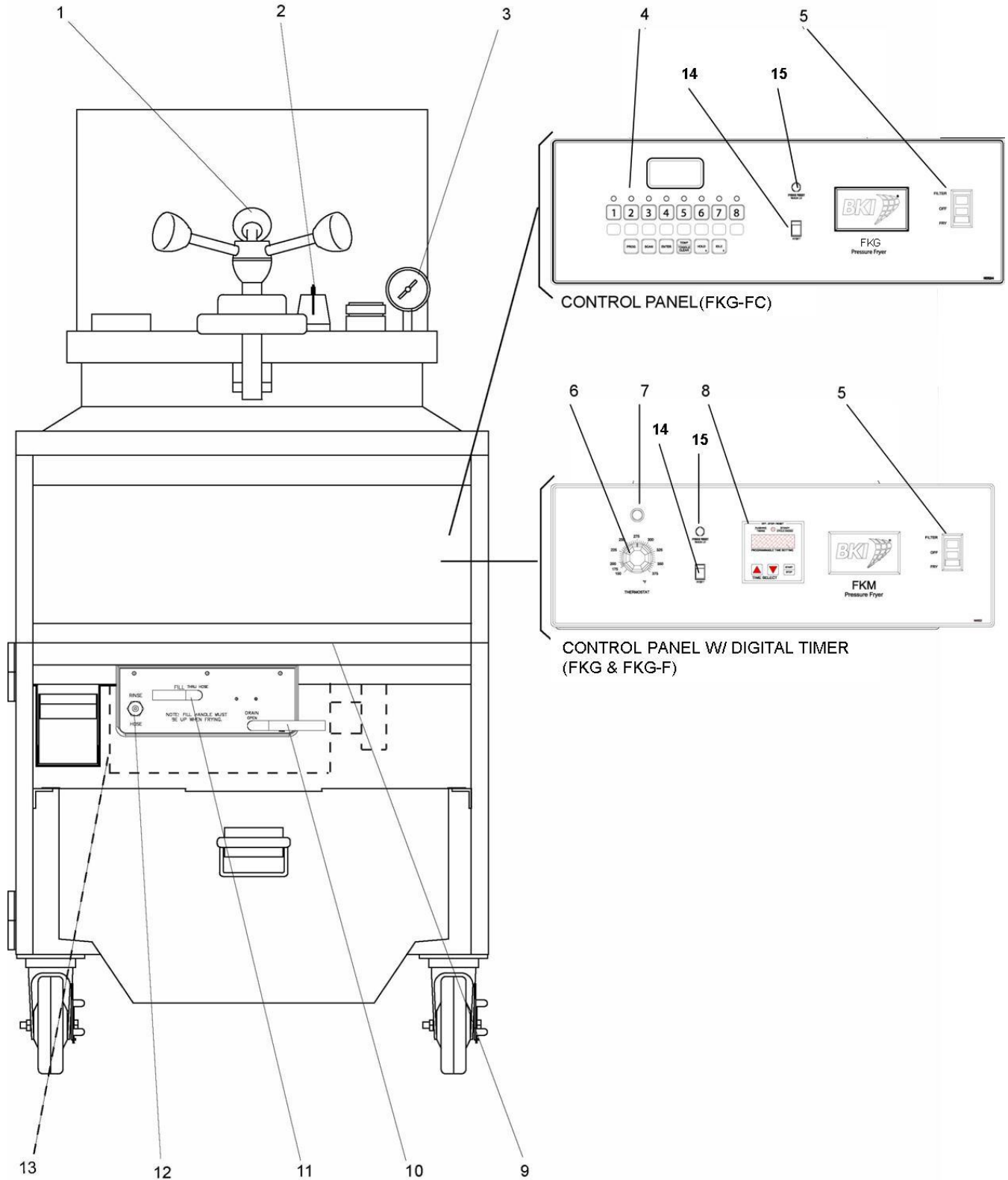

CONTROL PANEL (FKG-FC)

CONTROL PANEL W/ DIGITAL TIMER (FKG & FKG-F)

Item	Description	Function
1	Spin Handle	Used to tighten the lid to the pot once it is latched.
2	Pop Safety Valve lever	Used to release pressure periodically to prevent the seat from sticking.
3	Pressure Gauge	Indicates the pressure inside the pot.
4	Computer	Used to set and activate product programs.
5	Rocker Switch	FILTER – When placed in this position, power is applied to the motor and shorting is pumped into the pot directly or thru the fill hose. OFF – When placed in this position, power is removed from both the pump motor and gas system. FRY – When placed in this position, power is supplied to the thermostat and gas system.
6	Thermostat Knob	Used to set the temperature of the shortening.
7	Thermostat Light	Illuminates when the thermostat calls for heat. Extinguishes when the shortening temperature is reached.
8	Digital Timer	The digital timer consists of an LED, display, beeper and 8 buttons described below:
	LED indicator	Prior to the start of a timing cycle the LED will be OFF. When running a timing cycle the LED will flash. At the end of a timing cycle the LED will turn ON steady. When idle the LED is off.
	TIME SELECT (2 arrow buttons)	Two arrow buttons on the front panel are used to set the time. Hold the UP ARROW button down to increase the time. The longer the button is held down, the faster the rate at which the time will increase. The DOWN ARROW button is used in the same manner as the UP ARROW button except it will cause the time to decrease. The time is increased or decreased in 30-second increments.
	START/STOP button	Starting the Timer - Pressing this button while the timer is not active will cause the timer to begin counting down the time on the display. Stopping the Timer - Pressing this button while the timer is active will stop the timer from counting down and display the remaining time. Time cannot be changed with the TIME SELECT buttons at this point. If this button is pressed again the timer will continue counting down from the point it was stopped. Resetting the Timer - Pressing and holding this button for longer than two (2) seconds will reset the timer and the display will return to the original starting time. At this point, time can be changed using the TIME SELECT buttons or the preset buttons. Canceling The STIR OIL Function - Pressing this button cancels the STIR OIL function while it is active.
	ALARM button	This button allows the user to set an elapsed time at which the internal alarm will sound during a cycle. The time is set by pressing and holding the ALARM button while using the UP and DOWN arrows to change the time. The controller will limit the alarm time to be less than the currently programmed interval cycle time. The default alarm time is 0:00 which disables it. The ALARM time is saved on power down in the same manner as the last interval time. When a time cycle is running and the alarm time has elapsed the internal alarm will sound for 10 seconds. For example, a cycle time 10:00 and alarm time of 2:00 would cause the alarm to sound for 10 seconds once the controller has counted down from 10:00 to 8:00. This button is also used to cancel the STIR OIL function.

Item	Description	Function
	A, B, C, D preset buttons	These buttons are used to save and recall preset cycle and alarm times, saving operator time and minimizing error when changing interval cycle times and alarm times. To save the current interval and alarm times into one of the preset locations, press and hold the A, B, C, or D preset button for 2 seconds and the controller will double chirp to indicate the times have been saved. To recall any preset time, press and quickly release the appropriate button and the time values are loaded and displayed.
8	Beeper	A beeper sounds when the timer counts down to 0. Pressing the START/STOP button stops the beeper and resets the timer causing the display to return to the original starting time. At this point, time can be changed using the TIME SELECT buttons or the preset buttons. The beeper will also sound for 10 seconds if the alarm time has elapsed during a timing cycle. When the STIR OIL function begins the beeper will sound until the ALARM or START/STOP button is pressed.
	Display	Used to display the time. It also displays the words "STIR" then "OIL" in .5 second intervals until the ALARM or START/STOP button is pressed.
9	High Limit Reset Switch	If shortening inside the pot reaches an unsafe temperature, power is automatically removed from the control panel and the gas system shuts off. Pressing this switch returns power to the control panel and resets the gas system.
10	Drain Lever	DRAIN OPEN – When placed in this position, the drain valve opens and shortening drains into the vat. Also power is removed from the control panel and gas system. DRAIN CLOSED – When placed in this position, the drain valve is closed to prevent shortening from draining into the pot. Also power is restored to the control panel and gas system.
11	Fill Lever	FILL THRU POT – When placed in this position, shortening will be pumped from the vat to the pot if the rocker switch is in the FILTER position. FILL THRU HOSE – When placed in this position, shortening will be pumped from the vat to the pot via a fill hose if the rocker switch is in the FILTER position.
12	Rinse Hose Connector	Used to connect the Rinse hose for cleaning and refilling the pot.
13	Pump Motor Reset Switch	If the motor overheats while filtering, it will automatically shut off. Wait 15 minutes to allow motor to cool before pressing this switch.
14	Reset Switch	Used to reset the Ignition Module when it locks out during ignition.
15	Ignition Lock-out Light	Illuminates when the Ignition Module locks out during ignition.

Care of the Shortening

Solid shortening should always be returned to the filter vat while in the liquid state. If this is not done, it will have to be heated to a liquid state. When using solid shortening, the fryer must be equipped with a pump heater. After filtering with solid shortening, the filter lines must be completely emptied of shortening. The pump heater will take care of any residual shortening in the pump, but cannot melt all of the shortening in the filter lines. The pump heater accessory may be purchased separately from BKI.

To extend the life of your shortening, for the best possible flavor in your products, and for economy and efficiency of operation, we urge you to follow these recommendations:

1. Use only high-quality frying shortening without additives, of low moisture content and with a high smoke point.
2. Press excess moisture from products before breading. The more moisture released in the shortening, the quicker it will break down.
3. Filter at least once a day or once every three loads during frequent cooking.
4. Clean any residue or crust formations from the sides and bottom of the pot each time you filter the shortening.
5. Add fresh shortening as needed to maintain the proper shortening level **TO THE FILL MARK ON THE POT WALL.**
6. **DO NOT HOLD SHORTENING AT HIGH TEMPERATURE** when the fryer is not in use. If you expect an elapsed time of one hour or more between cooking, close the lid and press the "0" button on the FKG-FC model.
7. Shortening changes are determined by the quantity and type of food prepared. Excessive boiling and foaming are definite signs of shortening breakdown.
8. After you have finished frying for the day, filter the shortening and replace the filter pad. Also, thoroughly clean the pot of sediment and crumbs and empty the condensate pan.
9. **IMPORTANT!** Before the first cooking operation each day, stir the shortening freely while it is heating to provide a balanced shortening temperature for excellent results with the first cooking. Failure to do this can result in a crusty skin on the product surface with an undercooked product internally. In addition, in some cases, failure to stir the shortening while it is initially heating may cause the HI-LIMIT safety to disable the power due to a false overshoot condition.

FKG-FC Operation

System Programming

Use the following figure and table to set options that apply to each product programs.

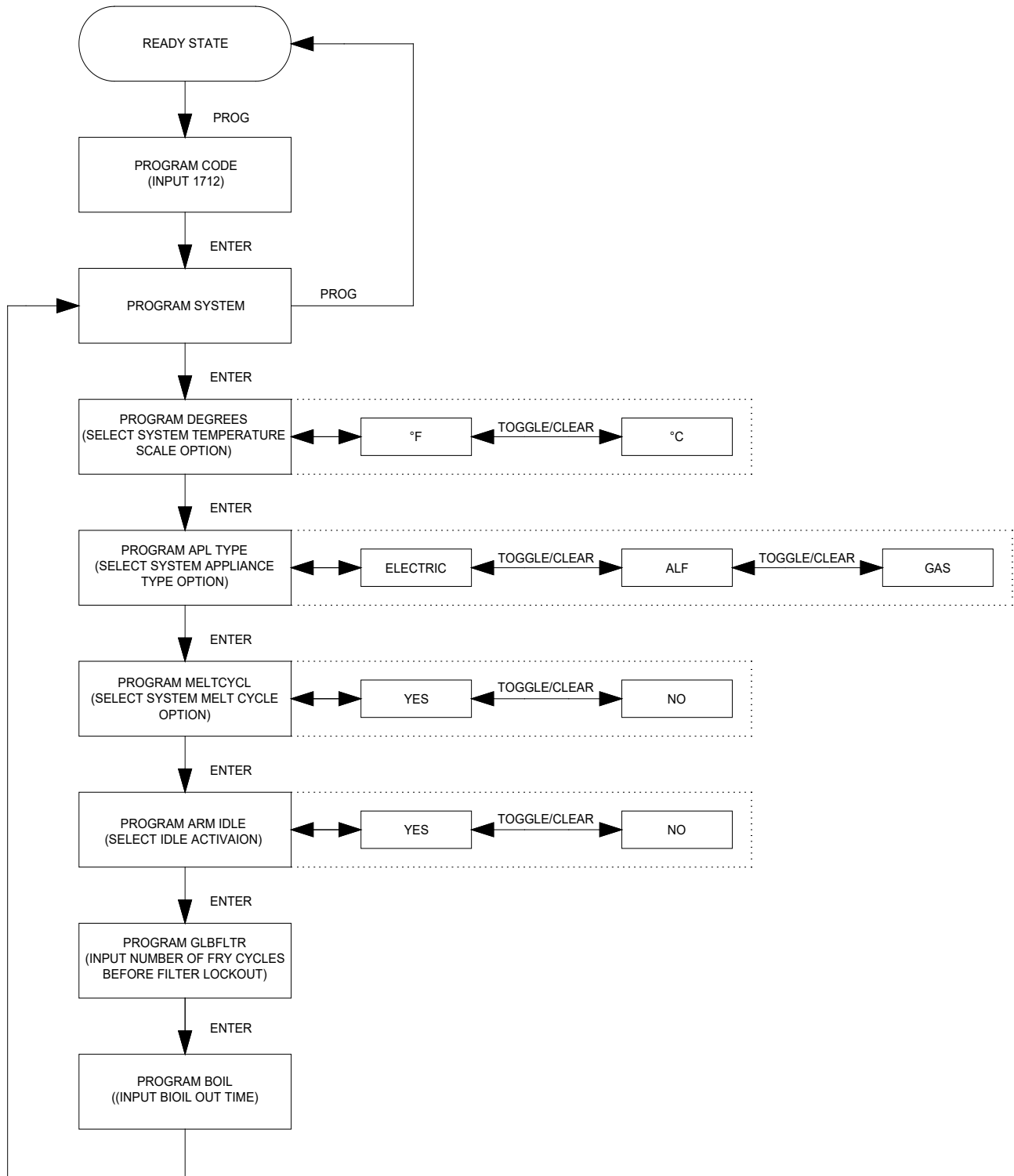

Figure 1. System Programming Sequence

Table 1. System Programming Procedure

STEP	ACTION	DISPLAY	COMMENTS
1	Press the FILTER/OFF/FRY switch to FRY .	Is Fry Pot Full? YES Press Enter	
2	Press ENTER	IDLE HEAT SET 275°F	
3	Press PROG on the keypad.	PROGRAM CODE	
4	Input 1712 and ENTER.	PROGRAM SYSTEM	
5	Press ENTER.	PROGRAM DEGREES °F	This command allows you to choose the temperature scale option you want to use. The display will show either show °F or °C.
6	Press TOGGLE/CLEAR until the desired option is displayed.	PROGRAM DEGREES X	X refers to the temperature scale you have chosen.
7	Press ENTER.	PROGRAM APL TYPE ELECTRIC	This command allows you to choose the appliance type you are using. The display may show ELECTRIC, GAS OR ALF.
8	Press TOGGLE/CLEAR until the desired option is displayed.	PROGRAM APL TYPE X	X refers to the appliance type you have chosen.
9	Press ENTER.	PROGRAM MELTCYCL YES	This command allows you to set the melt cycle option. This is normally set to yes if you are using solid shortening. The display will show either YES or NO.
10	Press TOGGLE/CLEAR until the desired option is displayed.	PROGRAM MELTCYCL X	X refers to the melt cycle option chosen.
11	Press ENTER.	PROGRAM ARM IDLE YES	This command allows you to set the idle activation option. The display will show either YES or NO.
12	Press TOGGLE/CLEAR until the desired option is displayed.	PROGRAM ARM IDLE X	X refers to the arm idle option chosen.
13	Press ENTER.	PROGRAM GLBLFLTR 0	This command allows you to specify the total number of fry cycles to complete among all product programs before a message is displayed reminding you to filter the shortening (filter lockout).
14	Press TOGGLE/CLEAR and input the number of fry cycles you want to complete among all product programs before enabling filter lockout.	PROGRAM GLBLFLTR X	X refers to the number of program cycles you want to complete among all product programs before filtering the shortening.

STEP	ACTION	DISPLAY	COMMENTS
15	Press ENTER.	PROGRAM BOIL 20:00	This command allows you to specify the boil out time. The time displayed may be a previously programmed value.
16	Press TOGGLE/CLEAR and input the number of minutes you want to clean.	PROGRAM BOIL XX:XX	XX:XX refers to the number of minutes you input.
17	Press ENTER.	PROGRAM SYSTEM	
18	Press PROG to exit the programming mode.	LOW	

Product Programming

Use the following figure and table to set a maximum of eight product programs. The product programs must be set before cooking can begin.

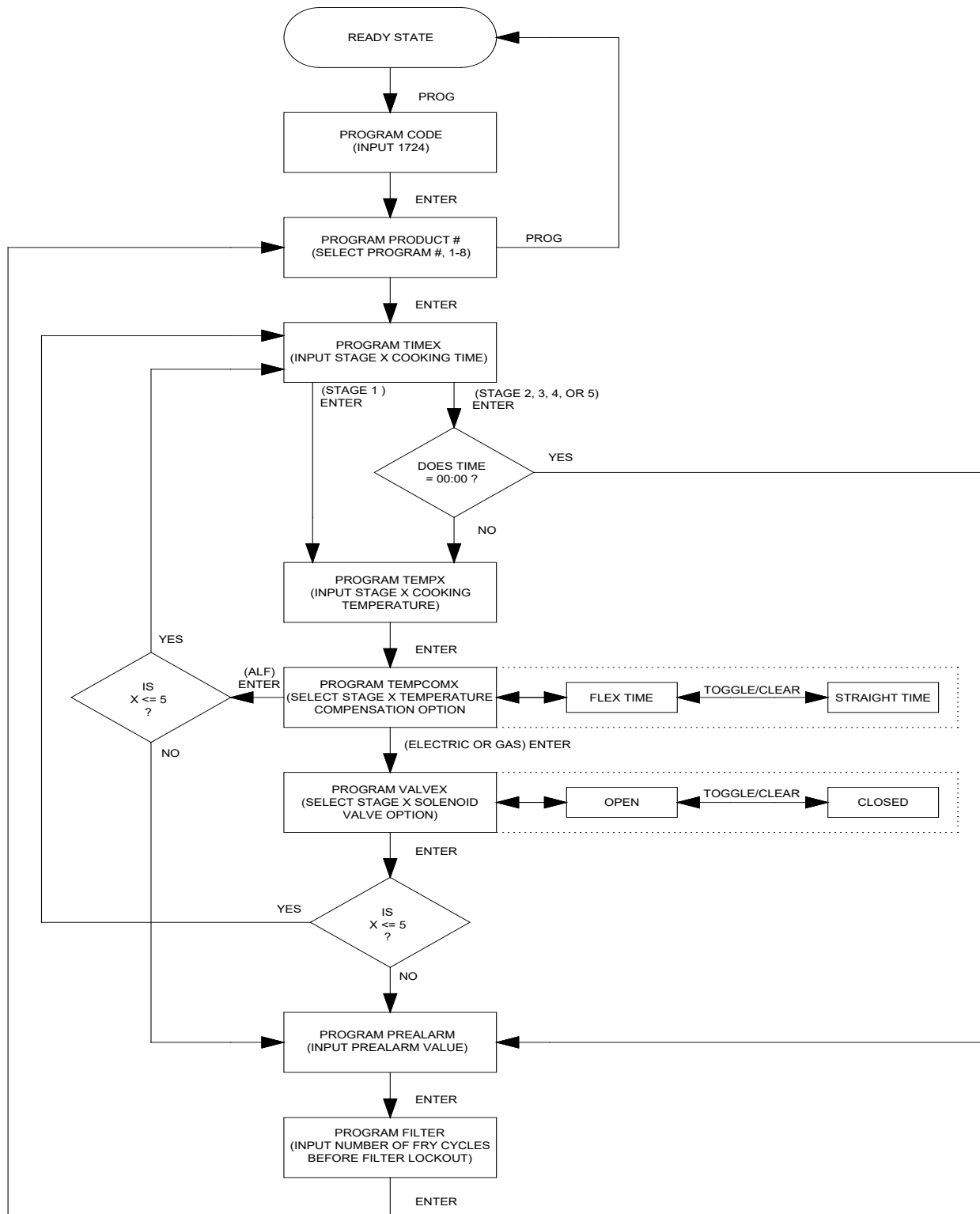

Figure 2. Product Programming Sequence

Table 2. Product Programming Procedure

STEP	ACTION	DISPLAY	COMMENTS
1	Press the FILTER/OFF/FRY switch to FRY .	LOW	
2	Press PROG on the keypad.	PROGRAM CODE	
3	Input 1724 and press ENTER.	PROGRAM PRODUCT #	
4	Select the program product number (1-8).	PROGRAM PRODUCT X	X refers to the program number you selected.
5	Press ENTER.	PROGRAM TIME1 00:00	This command allows you to specify the cooking time for this stage. The time displayed may be a previously programmed value.
6	Press TOGGLE/CLEAR and input the number of minutes you want to cook.	PROGRAM TIME1 XX:XX	XX:XX refers to the number of minutes you input.
7	Press ENTER.	PROGRAM TEMP1 000 °F	This command allows you to specify the cooking temperature for this stage. The temperature displayed may be a previously programmed temperature. The temperature scale may also display °C depending on the system option that is set.
8	Press TOGGLE/CLEAR and input the cooking temperature for product to be cooked.	PROGRAM TEMP1 XXX °F	XXX refers to the cooking temperature you input.
9	Press ENTER.	PROGRAM TEMPCOM1 FLEX TIME	This command enables you to select whether or not time is allowed for the fryer to recover from temperature loss while cooking during this stage. The FLEX TIME option will allow the fryer to recover from temperature loss.
10	Press TOGGLE/CLEAR until the desired option is displayed.	PROGRAM TEMPCOM1 X	X refers to the temperature compensation option selected.
11	Press ENTER.	PROGRAM VALVE1 CLOSED	This command allows you to specify whether the solenoid valve will be open or closed during this stage.
12	Press TOGGLE/CLEAR until the desired option is displayed.	PROGRAM VALVE1 X	X refers to the solenoid valve option selected. OPEN is used for Models ALF and BLF Automatic Lift fryers. If your program requires the solenoid valve to be closed while cooking, choose the CLOSED option.

STEP	ACTION	DISPLAY	COMMENTS
13	Repeat steps 5-12 when programming stages 2, 3, 4 and 5 for Electric and Gas appliance types. Repeat steps 5-10 when programming stages 2, 3, 4 and 5 for an ALF appliance type.		The time and temperature of each stage has to be less than the preceding stage.
14	Press ENTER.	PROGRAM PREALARM 00:00	This command allows you to specify the number of minutes before the end of the cooking time (for each stage) until the alarm sound. The prealarm value displayed may be a previously programmed value.
15	Press TOGGLE/CLEAR and input the prealarm minutes.	PROGRAM PREALARM XX:XX	XX:XX refers to the prealarm minutes you input.
16	Press ENTER.	PROGRAM FILTER 0	This command allows you to specify the number of fry cycles you want to complete for this program before a message is displayed reminding you to filter the shortening (filter lockout). The filter value displayed may be a previously programmed value.
17	Press TOGGLE/CLEAR and input the number of fry cycles you want to complete before enabling filter lockout.	PROGRAM FILTER X	X refers to the number of program cycles you want to complete before filtering the shortening.
18	Press ENTER.	PROGRAM PRODUCT #	
19	If you wish to input more programs, proceed by pressing the next program number and follow steps 5 through 18 or press PROG to exit the programming mode.		

Start-Up (FKG-FC)

1. Make sure the main drain valve is closed.



2. Fill pot with shortening to about one inch below the mark.

WARNING

Risk of fire exists if the oil level drops below the minimum oil level. The level of oil within the pot must not fall below 5mm of the maximum oil level.

WARNING

Use of oil/shortening older than the manufacturers recommendations for life of the oil is prone to surge boiling and flash fires. Follow the oil manufacturers guidelines for lifecycle of oil/shortening.

CAUTION

Overfilling the fryer pot with shortening could lead to serious injury. Ensure that the fryer pot is filled with shortening only to the fill mark when shortening is hot. Do not use any shortening other than what is specified in this manual and do not overfill the fryer pot.

CAUTION

The fryer has a maximum temperature setting of 375° F/191° C. Do not use oil/shortening with a flashpoint less than 554° F (290° C)

NOTICE

Use only high-quality shortening that has low moisture content, a high smoke point and no additives.



3. Place the **FILTER/OFF/FRY** switch to the **FRY** position. The question “Is the Fry Pot filled – If yes press ENTER” will appear on the computer display. The computer will display IDLE and will heat to 275°F.

Press one of the recipe buttons to preheat the oil to the setpoint temperature. The shortening will heat and begin to reach the fill mark inside the pot.

4. Stir the oil freely while it is heating. Press the **0** button when up to temperature to put in IDLE mode.

IMPORTANT! Before the first cooking operation each day, stir the shortening freely while it is heating to provide a balanced shortening temperature for excellent results with the first cooking. Failure to do this can result in a crusty skin on the product surface with an undercooked product internally. In addition, in some cases, failure to stir the shortening while it is initially heating may cause the HI-LIMIT safety device to disable the power due to a false overtemperature condition.

Cooking (FKG-FC)



WARNING

Do not open the drain valve or the fill valve while the fryer is under pressure. Serious burns may result.

1. Ensure that the Start-Up procedures have been performed.
2. Press the desired program number on the keypad. The computer will still display "**LOW**". The fryer will begin to heat to the temperature that has been factory preset. When "**READY**" appears on the display, the fryer is up to the desired temperature and the product can be loaded.
3. When frying chicken, lower the basket into the shortening in the fryer pot.



WARNING

Hot shortening may splash out of the pot causing severe injury when dropping chicken into pot. Carefully drop pieces of chicken into pot to prevent shortening splashes.

4. Carefully drop the chicken in the shortening one piece at a time starting with thighs and breasts. The fryer is designed to accommodate 48-50 pieces of chicken.



DANGER

Failure to use the insulated mitts will result in severe injury. Always use the insulated mitts when handling the hot fry basket.

5. Lift the basket and shake it. This keeps the food from sticking together and causing white spots on the cooked food.



WARNING

Hot shortening may splash out of the pot causing severe injury when lowering basket into pot. Carefully lower basket into pot to prevent shortening splashes.

6. Slowly lower the fryer basket into fryer.
7. Close the lid. Make sure the lid snaps shut. Make sure the lid hook latches securely under the catch.
8. Tighten the spin handle until the lid is firmly sealed. Then line up the orange knob on the spin handle with the orange knob at the front of the fryer.



9. Press the desired program number a second time. The red light above the program number will flash and the computer will display "**COOK**". This will start a countdown in minutes and seconds until the end of the cycle.
10. At the end of the cooking cycle, the computer will display "**DONE**" and signal with a series of audible "beeps". Press the selected number once again to stop the cook cycle. Fifteen seconds before the end of the cook cycle, the program will automatically release the pressure from the fryer. For your safety, the lid will not unlock, even at the end of the cook cycle, until the pressure has been fully released.

WARNING

Hot steam will escape when you open the lid possibly causing severe injury. Keep your face and arms away from the fry pot.

11. Slowly turn the spin handle counterclockwise to break the seal around the lid. Your fryer has a locking pin that prevents turning the spin handle until the pressure drops to "0".
12. Slowly open the lid.

DANGER

Failure to use the insulated mitts will result in injury. Always use the insulated mitts when handling the hot fry basket.

13. Lift the basket and hang it on the front of the fryer pot to drain.
14. Empty the basket.
15. Remember to filter the shortening at least every third frying cycle load. Refer to the procedure in this manual. Also filter the shortening and clean the fryer at the end of each day.
16. Close the lid and press the **0** button. **Idle 275°F** will display. This will automatically hold the shortening at a cooler temperature.
17. To escape the idle mode, press the **0** button again and the fryer will heat to its original temperature.

When you have finished frying for the day, turn the **FILTER/OFF/FRY** switch to the **OFF** position.

Operation after Gas or Power Outage

The fryer may shut off automatically if the gas supply is interrupted or the power goes out. If either of these conditions occur, you should perform the following procedure:



For your safety, if the gas supply stops, or, if the power goes out, make sure to wait for at least five minutes before restarting your fryer. This allows time for any unburned gas to dissipate. (LP gas may take longer than five minutes.) If you smell gas, do not start your fryer.

1. Place the **FILTER/OFF/FRY** switch in the **OFF** position.
2. Wait at least five minutes to allow any gas that may have accumulated in the burner compartment to escape.
3. Follow normal operating procedures once the power or gas is restored.

Normal Shutoff

1. Place the **FILTER/OFF/FRY** switch in the **OFF** position.
2. Wait at least five minutes to allow any gas that may have accumulated in the burner compartment to escape.

Maintenance



Failure to comply with the maintenance below could result in a serious accident.

Do not over-tighten the spindle assembly. (Only tighten to hold pressure.)

Your fryer will need periodic maintenance and servicing. We strongly suggest that you use only a service company that is authorized by BKI to do this work.

The restraining device must always be connected when the appliance is in service. Disconnect for movement, such as servicing or cleaning. Reconnect the restraint when fryer has been returned to its normal position.

The FKG appliance is not intended to be cleaned with a water jet.

Scheduled Maintenance

Use the following table to help manage scheduled maintenance activities.

FREQUENCY	PERFORMED BY	PART	ACTIVITY
Each Fry Cycle	User	Pressure Gauge	Check for proper display of cooking vat pressure. Contact authorized BKI service agent if adjustment or replacement is required.
	User	Lid Gasket	Check for unusual wear such as cracks and deformation, and pressure leaks. Contact authorized BKI service agent if adjustment or replacement is required.
Daily	User	Dead Weight Assembly	Clean weight and orifices daily and check for wear.
	User	Filter Pad	Replace filter pad. Refer to the procedure in this manual.
	User	Condensation Pan	Remove and drain.
	User	Filter system	Filter the shortening using the procedure in this manual.
Weekly	User	Safety Pop Valve	Check for release of pressure and proper seal. Refer to the procedure in this manual.
	User	Fryer Pot	Perform the boil-out procedure in this manual.
Every 6 Months	Authorized BKI service agent	Acme Screw and Nut	Check for wear on the threads.
	Authorized BKI service agent	Solenoid Valve	Check that the valve is holding and releasing pressure when the timer or computer activates it.
	Authorized BKI service agent	Hook, Catch, Spring	Check for wear and ease of operation.
	Authorized BKI service agent	Connections, Fittings	Check for leakage while oil is pumping.

FREQUENCY	PERFORMED BY	PART	ACTIVITY
	Authorized BKI service agent	Fryer Pot Fittings/Connections	Check for leakage around fry pot top deck and fittings (heaters, hi-limit, thermostat, etc.).

Safety Pop Valve Procedure

The safety pop valve should be blown under pressure periodically to prevent the seat from sticking.



Failure to use the insulated mitts will result in injury. Always use the insulated mitts when handling the arm on the safety valve.

1. After the pressure is up during a cooking cycle, use the insulated glove to lift the arm on the edge of the safety valve and let some steam escape. This will clean the valve.

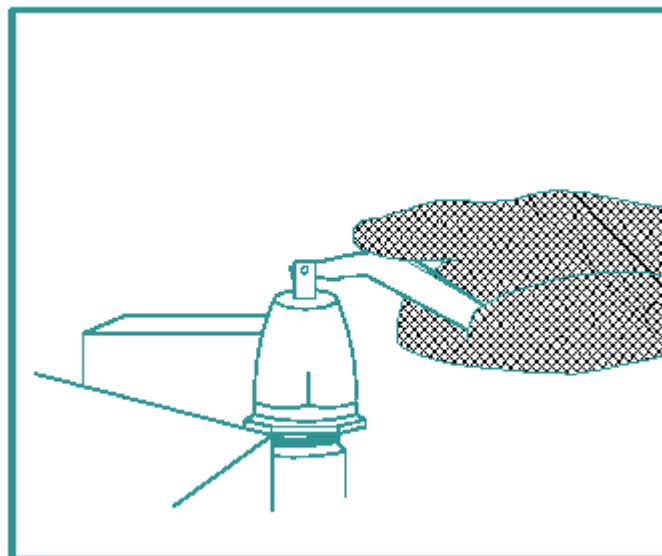

2. Release the lever on the valve, and let it slam shut to seal the valve.

Filtering Procedure

Breaded foods require frequent filtering. An excess amount of breading left in the fryer pot will reduce the life of the shortening. We recommend the shortening be filtered after every three frying cycle loads. If the shortening starts to show signs of foaming and has a bad taste, do not use it. The fryer pot should be cleaned before refilling with new shortening. Best results for filtering are obtained while the shortening is hot. You should filter at the end of every business day. You should also remove and drain the condensation pan daily.

WARNING

Always wear appropriate personal protection equipment during the filtering process to guard against possible injury from hot oil.

If the pump motor automatically shuts off while filtering, place the FILTER/OFF/FRY switch in the OFF position, wait 15 minutes, press the pump motor reset button, then follow the appropriate refill procedure below.

WARNING

Do not open the drain valve or the fill valve while the fryer is under pressure. Serious burns may result.

1. Set the **FILTER/OFF/FRY** switch to **OFF**.
2. Remove the fryer basket.
3. Make certain that the filter pad is clean and not torn.

IMPORTANT: Make certain the vat cover is properly positioned underneath the drain valve. Also make certain the filter vat and filter screen is under the main drain valve before starting the filtering process.

4. Move the DRAIN handle slowly to the OPEN position so that the shortening starts to flow evenly. This is to prevent excessive splashing of hot shortening.
5. When the pot is empty, place the DRAIN handle in the CLOSED position.

To refill the pot automatically, use the steps below:

WARNING

Hot shortening may splash out of the pot causing severe injury when filling the pot if the lid is not closed. To prevent shortening splashes, close the lid before filling.

- Close the lid to prevent shortening splashes.
- Place the FILL handle to the THRU POT position.
- Position the **FILTER/OFF/FRY** switch to **FILTER** and shortening will automatically pump into the pot.
- After 1 minute carefully open the lid to check the level of the shortening.
- Let the filter continue to pump the shortening until the fill mark in the fryer pot is reached or until air starts bubbling through the shortening.
- As soon as air is seen in the shortening, first place the FILL handle to the THRU HOSE position then position the **FILTER/OFF/FRY** switch to **OFF** to prevent shortening degradation and prevent the filter pump and lines from filling up with shortening.
- Add new shortening if the fill mark has not been reached.

To refill the pot through the rinse hose, use the steps below:

- Make certain that the rinse hose is connected to rinse hose connector.
- Holding the hose by the handle, place hose nozzle inside the pot.



Hot shortening may splash out of the pot causing severe injury when filling the pot if the lid is not held down over the hose nozzle. To prevent shortening splashes, hold the lid down over the hose nozzle.

- Hold the lid down over the hose nozzle to prevent shortening splashes.
- Position the FILL lever in the THRU HOSE position.
- Position the **FILTER/OFF/FRY** switch to **FILTER** and shortening will automatically pump into the pot.
- After 1 minute, hold the hose by the handle and carefully raise the lid to check the level of the shortening.
- Let the filter continue to pump the shortening until the fill mark in the fryer pot is reached or until air starts bubbling through the shortening.
- As soon as air is seen in the shortening, position the **FILTER/OFF/FRY** switch to **OFF** to prevent shortening degradation.
- Add new shortening if the fill mark has not been reached.

Boil-Out Procedure

Boil-outs remove microscopic particles of carbon that build up on the walls of the fryer pot. To avoid eventual carbon build-up, off flavors, and shortening breakdown, boil-outs should be done once a week on each fryer following these procedures.



Always wear appropriate personal protection equipment during the boil-out process to guard against possible injury from hot cleaning solution.

1. Position the **FILTER/OFF/FRY** switch to **OFF**.
2. Drain the clean shortening into an adequate storage container. (**Allow the shortening to cool to room temperature before attempting storage.**)
3. CLOSE the drain and fill the fryer pot with **HOT** water to the shortening level fill mark. Do not overfill by allowing the water level higher than the fill mark.
4. Add cleaner. BKI recommends BKI Cleaner (P/N LC0006) or equivalent.
5. Wash down the inside of the pot and lid with the pot brush to loosen the sediment.
6. Set the temperature of the solution and heat it up as follows:
 - **FKG-FC** – Position the **FILTER/OFF/FRY** switch to **ON**. Press ENTER and then BOIL OUT. The display will read BOIL NOW? Use TOGGLE/CLEAR button to select YES or NO and press ENTER. The control will say CLEAN and flash HEAT and the fryer pot will heat to a temperature of 195° F. Once it reaches temperature it will beep 3 times, indicating the pot should be scrubbed with the brushes, and the temperature will go to 190°F. The display will change to CLEAN to allow the CLEAN function to be performed and count down the time set in the system settings. At the end of the countdown the display will say CLEAN COMPLETE TURN OFF and will beep until the fryer is turned off.

-
7. Place the **FILTER/OFF/FRY** switch to **OFF**.
 8. Scrub the inside of the fryer pot and inside of the lid again.
 9. **Before draining the cleaning solution**, remove the filter bag, screen and pipe connections from the filter vat. This must be done before draining the cleaning solution. **NEVER** pump water or detergent through the filter system.
 10. After 15 minutes, slowly open the drain valve. Drain the solution into the filter vat and discard.
 11. Rinse the pot with hot water, using the pot brush to remove remaining sediment, drain and discard.
 12. Close the drain and refill the fryer pot with hot water to the proper level.
 13. Add approximately 4 to 6 ounces of distilled (white) vinegar to develop a neutralizing solution. Stir the solution briefly. Leave in the pot for three to five minutes and discard. **NOTE: Foaming of shortening after boil-outs is caused by failure to follow proper neutralizing procedures.**
 14. Repeat steps 12 through 14 as needed to remove all traces of cleaning solution.
 15. Rinse the pot again with Cool water, drain and discard.

**CAUTION**

Damage to the fryer could result if the fryer pot is not completely dry before filling with shortening. Refill the fryer pot with shortening **ONLY** when it is completely dry.

16. Dry the fryer pot, lid, and filter vat **COMPLETELY**.
17. Close the main drain and fill with new shortening to the proper level.

Filter Pad Replacement

The filter pad must be replaced daily. If the shortening has a milky color when it is pumped into the pot, the filter pad should be replaced immediately.

CAUTION

If the filter pad is not properly closed, breading crumbs will get through the pad opening and clog the pump. Ensure that the filter pad is properly closed upon replacement.

1. Place the filter screen inside the filter pad.
2. Fold the end of the pad and seal with the bag clip.

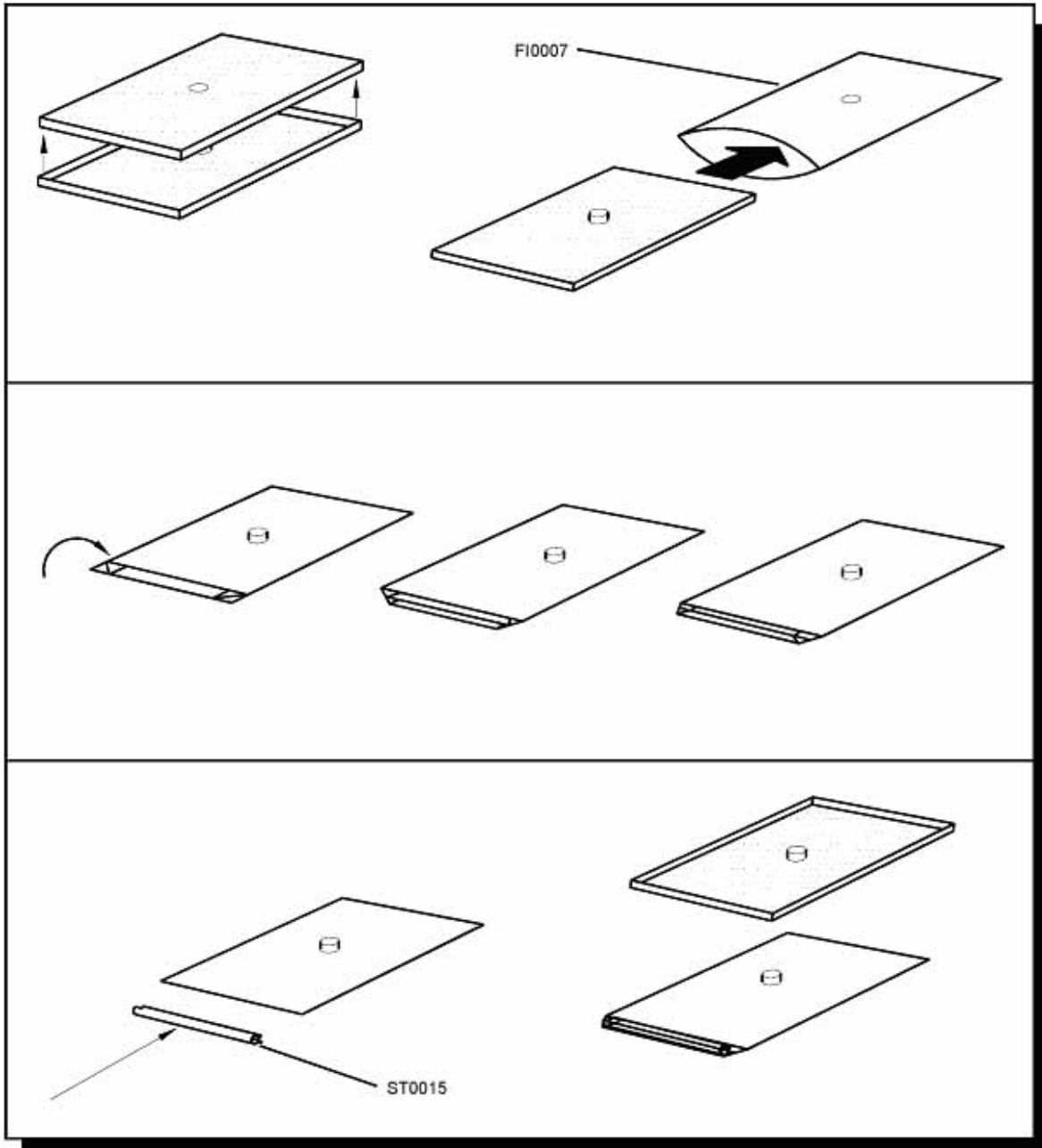

Troubleshooting

Refer to the table below for troubleshooting information.

Problem	Cause	Possible Solution
Pressure Loss or Not Releasing Pressure	Dead Weight Valve Leaking	Clean the weight and orifice. If problems persist, contact an authorized BKI service agent for corrective action.
	Lid Gasket Leaking	Contact an authorized BKI service agent for corrective action.
	Solenoid Valve Leaking or Stuck	After a period of time, it is possible that the valve seat and/or plunger may stick or wear. Activate the valve by starting a cook cycle. You should hear a solid metallic CLICK sound from the solenoid valve. If you should hear no sound (or a slow BUZZING CLICK), contact an authorized BKI service agent for corrective action.
	Safety Valve not seating	Contact an authorized BKI service agent for corrective action.
Shortening Heating Too Slowly	Gas pressure is low or isn't adjusted properly	Contact an authorized BKI service agent for corrective action.
	Bad thermostat or loose wires	Contact an authorized BKI service agent for corrective action.
Filter System Not Working	Uncertain	Press the reset button on end of pump and hi-limit reset button under control panel. If problems persist, contact an authorized BKI service agent for corrective action.
	Connections not tight	Tighten the connections. If problems persist, contact an authorized BKI service agent for corrective action.
	Filter valve not open	Contact an authorized BKI service agent for corrective action.
	Filter paper on screen clogged with crumbs	Change filter paper. If problems persist, contact an authorized BKI service agent for corrective action.
	Motor hums, but does not pump	Check for clogged pump. If problems persist, contact an authorized BKI service agent for corrective action.
	Motor and pump coupling worn	Contact an authorized BKI service agent for corrective action.
	No power to control panel	Make sure drain valve is completely closed. If problems persist, contact an authorized BKI service agent for corrective action.
Computer Hangs	Computer malfunction.	Press and hold the Toggle/Clear button while moving the FRY/OFF/FILTER switch from FRY to OFF and back to FRY. If problems persist, contact an authorized BKI service agent for corrective action.

Notes



42 Allen Martin Drive, Essex Junction, VT 05452, USA
<http://www.bkideas.com>

Made and printed in the U.S.A

SS-OM-048.05

Revised 09/01/2020

REVISION HISTORY

<u>REVISION</u>	<u>DATE</u>	<u>REVISED BY</u>	<u>DESCRIPTION</u>
01	10/1/2013	MSS	Initial Release-Supersedes all previous releases
02	06/07/16	JDS	LCO 16-002 - Corrected Idle Temperature, was 255°F now 275°F
03	04/18/18	JDS	LCO 18-002 Added Caster Information and Boil Out Button Functionality.
04	09/12/18	KW	Added required Warning for California residents and BKI Worldwide is a subsidiary of Standex Int'l Corp.
05	9/1/2020	CF	Change warranty