



Large All-Purpose Fryer Series

SERIES: DNF

Operation Manual



BKI LIMITED WARRANTY

2812 Grandview Dr. • Simpsonville, SC 29680 • USA
(864) 963-3471 • Toll Free: (800) 927-6887 • Fax: (864) 963-5316

WHAT IS COVERED

This warranty covers defects in material and workmanship under normal use, and applies only to the original purchaser providing that:

- The equipment has not been accidentally or intentionally damaged, altered or misused;
- The equipment is properly installed, adjusted, operated and maintained in accordance with national and local codes, and in accordance with the installation and operating instructions provided with this product.
- The serial number rating plate affixed to the equipment has not been defaced or removed.

WHO IS COVERED

This warranty is extended to the original purchaser and applies only to equipment purchased for use in the U.S.A.

COVERAGE PERIOD

- Warranty claims must be received in writing by BKI within one (1) year from date of installation or within one (1) year and three (3) months from data of shipment from the factory, whichever comes first.
- COB Models: One (1) Year limited parts and labor.
- COM Models: Two (2) Year limited parts and labor. COM convection ovens also have a two (2) year door warranty.
- CO1 Models: Two (2) Year limited parts and labor. Five (5) Year limited door warranty.
- BevLes Products: Two (2) Year limited parts and labor.
- Warranty period begins the date of dealer invoice to customer or ninety (90) days after shipment date from BKI, whichever comes first.

WARRANTY COVERAGE

This warranty covers on-site labor, parts and reasonable travel time and travel expenses of the authorized service representative up to (100) miles round trip and (2) hours travel time and performed during regular, weekday business hours.

EXCEPTIONS

Any exceptions must be pre-approved in advance and in writing by BKI. The extended door warranty on convection ovens years 3 through 5 is a parts only warranty and does not include labor, travel, mileage or any other charges.

EXCLUSIONS

- Negligence or acts of God,
- Thermostat calibrations after (30) days from equipment installation date,
- Air and gas adjustments,
- Light bulbs,
- Glass doors and door adjustments,
- Fuses,
- Adjustments to burner flames and cleaning of pilot burners,
- Tightening of screws or fasteners,
- Failures caused by erratic voltages or gas suppliers,
- Unauthorized repair by anyone other than a BKI Factory Authorized Service Center,
- Damage in shipment,
- Alteration, misuse or improper installation,
- Thermostats and safety valves with broken capillary tubes,
- Freight - other than normal UPS charges,
- Ordinary wear and tear,
- Failure to follow installation and/or operating instructions,
- Events beyond control of the company.

INSTALLATION

Leveling, as well as proper installation and check out of all new equipment - per appropriate installation and use materials – is the responsibility of the dealer or installer, not the manufacturer.

REPLACEMENT PARTS

BKI genuine Factory OEM parts receive a (90) day materials warranty effective from the date of installation by a BKI Factory Authorized Service Center.

Table of Contents

Table of Contents	1
Introduction	2
Safety Precautions.....	2
Safety Signs and Messages.....	2
Safe Work Practices	3
Safety Labels.....	7
Installation	8
Unpacking and Handling.....	8
Assembly and Mounting	8
Wiring.....	8
Initial Test and Adjustment	9
Operation	10
Controls and Indicators	10
Care of the Shortening.....	12
Start-Up.....	13
Cooking Yeast Doughnuts	14
Cooking Cake Doughnuts.....	15
Maintenance	16
Scheduled Maintenance	16
Filtering Procedure	17
DNF-F.....	17
DNF	18
Boil-Out Procedure	18
Filter Pad Replacement.....	20
Troubleshooting	21

BKI Worldwide is a wholly owned subsidiary of Standex International Corporation.

Introduction

The **BKI** Doughnut Fryer is intended for general commercial use. It consists of an oil vat, 2 electrical control panels, a manual drain control and an oil filter system (DNF-F only). The oil vat holds the cooking oil that is heated by tubular heating elements. The Lower Electrical Panel controls and indicates power to the unit as well as power to the filter system. This panel also contains 2 fuses that protect the circuitry within the unit. The Upper Electrical Panel contains a thermostat that regulates the oil temperature and a push button for resetting the heating elements in the event of an overtemperature condition. A drain control is provided behind the door to allow the user to drain the cooking oil for filtering purposes. The DNF-F comes with a built-in oil filter system consisting of an oil container, filter screen assembly and pump motor/piping necessary to filter cooking oil.

The BKI name and trademark on this unit assures you of the finest in design and engineering -- that it has been built with care and dedication -- using the best materials available. Attention to the operating instructions regarding proper installation, operation, and maintenance will result in long lasting dependability to insure the highest profitable return on your investment.

NOTICE

PLEASE READ THIS ENTIRE MANUAL BEFORE OPERATING THE UNIT. If you have any questions, please contact your BKI Distributor. If they are unable to answer your questions, contact the BKI Technical Service Department, toll free: 1-800-927-6887. Outside the U.S., call 1-864-963-3471.

Safety Precautions

Always follow recommended safety precautions listed in this manual. Below is the safety alert symbol. When you see this symbol on your equipment, be alert to the potential for personal injury or property damage.

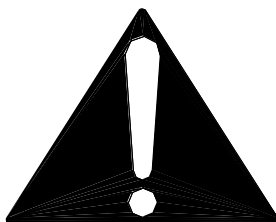

Safety Signs and Messages

The following Safety signs and messages are placed in this manual to provide instructions and identify specific areas where potential hazards exist and special precautions should be taken. Know and understand the meaning of these instructions, signs, and messages. Damage to the equipment, death or serious injury to you or other persons may result if these messages are not followed.

DANGER

This message indicates an imminently hazardous situation which, if not avoided, will result in death or serious injury.

WARNING

This message indicates a potentially hazardous situation, which, if not avoided, could result in death or serious injury.

CAUTION

This message indicates a potentially hazardous situation, which, if not avoided, may result in minor or moderate injury. It may also be used to alert against unsafe practices.

NOTICE

This message is used when special information, instructions or identification are required relating to procedures, equipment, tools, capacities and other special data.

Safe Work Practices



Beware of High Voltage

This equipment uses high voltage. Serious injury can occur if you or any untrained or unauthorized person installs, services, or repairs this equipment. Always Use an Authorized Service agent to Service Your Equipment



Noncombustible Floors Only

Make sure your floor is noncombustible. Do not operate your fryer on floors that are wood, carpeted or have rubber mats.

- Placing your fryer on a combustible floor could cause a fire. Serious injury could result.
- Examples of noncombustible floors where you can safely place your fryer are concrete, tile, and ceramic.



Keep The Area Around Your Fryer Uncluttered

Make sure to keep the area around your fryer clear of any obstacles.

Serious injury can occur if you trip or fall near the fryer. You could be burned by hot shortening that splashes out of the fryer or by falling against the hot metal of the fryer.



Keep The Floor Around Your Fryer Clean Of Shortening

Make sure to keep the floor around your fryer clean of shortening and other liquids.

Serious injury can occur if you slip near your fryer. You could be burned by hot shortening that splashes out of the fryer or by falling against the hot metal of the fryer.



Keep The Lid Closed When The Fryer Is Not In Use

Hot shortening can splash if someone moves the fryer or bumps into it. Serious injury can occur if hot shortening splashes out of the fryer.

Do not lean, sit or stand on the fryer or perform any maintenance or cleaning duties while the fryer or the shortening is hot. You could be burned.

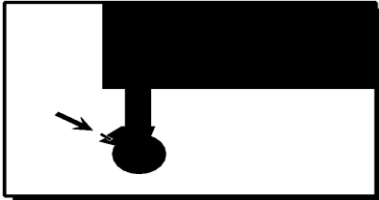

Keep The Casters Locked

To avoid spilling shortening, keep the casters locked. If any shortening spills near your fryer, clean it up immediately.

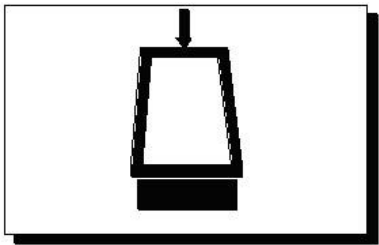

Do Not Overfill The Fryer With Shortening

Hot shortening and steam may escape and burn you if you put too much shortening in the fryer. Fill the fryer to approximately one inch below the fill marks that are inside the fryer vat. Heat the shortening. If needed, carefully add more shortening to bring the level to the fill marks.



Do Not Let Any Water Get Into The Fryer

Always remove excess moisture from food before placing it into the fryer vat. Water will cause the hot shortening to spatter. You could be burned.

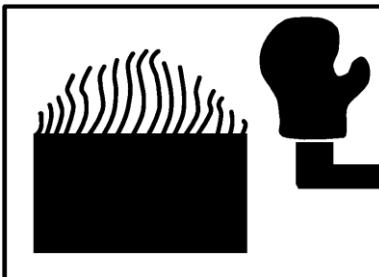

Wear Safe Clothing Appropriate To Your Job

Always wear your insulated mitts when handling the racks or touch any hot metal surfaces. You received a pair of insulated mitts with your fryer. If you lose or damage your mitts, you can buy new ones at your local restaurant equipment supply store or from your local **BKI** Distributor.

Always wear non-skid shoes when working around the fryer or any other equipment that uses shortening. Never wear loose clothing such as neckties or scarves while operating your fryer. Keep loose hair tied back or in a hair net while operating your fryer.

Always wear appropriate personal protection equipment during the filtering process to guard against possible injury from hot oil.

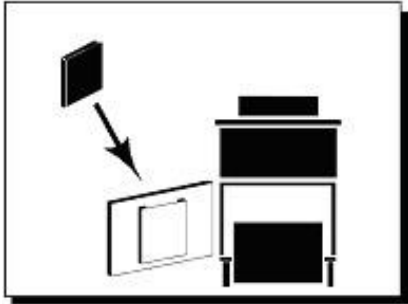

Keep this manual with the Equipment

This manual is an important part of your equipment. Always keep it near for easy access.

If you need to replace this manual, contact:

BKI

Technical Services Department
2812 Grandview Drive
Simpsonville, S.C. 29680
Or call toll free: 1-800-927-6887
Outside the U.S., call 864-963-3471



Protect Children

Keep children away from this equipment. Children may not understand that this equipment is dangerous for them and others.

NEVER allow children to play near or operate your equipment.

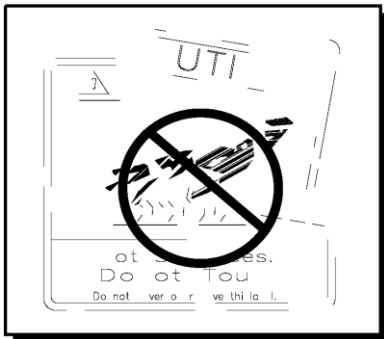

Keep Safety Labels Clean and in Good Condition

Do not remove or cover any safety labels on your equipment. Keep all safety labels clean and in good condition. Replace any damaged or missing safety labels. Refer to the Safety Labels section for illustration and location of safety labels on this unit.

If you need a new safety label, obtain the number of the specific label illustrated on page 7, then contact:

BKI

Technical Services Department
2812 Grandview Drive
Simpsonville, S.C. 29680
Or call toll free: 1-800-927-6887
Outside the U.S., call 864-963-3471

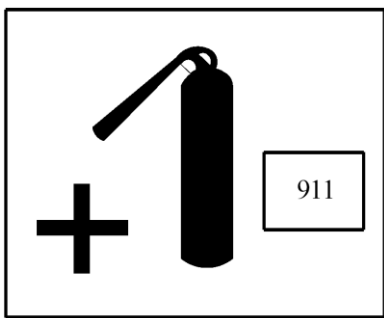

Be Prepared for Emergencies

Be prepared for fires, injuries, or other emergencies.

Keep a first aid kit and a fire extinguisher near the equipment. You must use a 40-pound Type BC fire extinguisher and keep it within 25 feet of your equipment.

Keep emergency numbers for doctors, ambulance services, hospitals, and the fire department near your telephone.

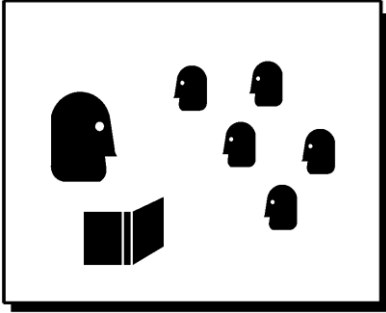
**Know your responsibilities as an Employer**

- Make certain your employees know how to operate the equipment.
- Make certain your employees are aware of the safety precautions on the equipment and in this manual.
- Make certain that you have thoroughly trained your employees about operating the equipment safely.
- Make certain the equipment is in proper working condition. If you make unauthorized modifications to the equipment, you will reduce the function and safety of the equipment.



California Residents Only. This product can expose you to chemicals including chromium, and lead which are known to the State of California to cause cancer and birth defects or other reproductive harm. For more information go to www.P65Warnings.ca.gov.

Safety Labels

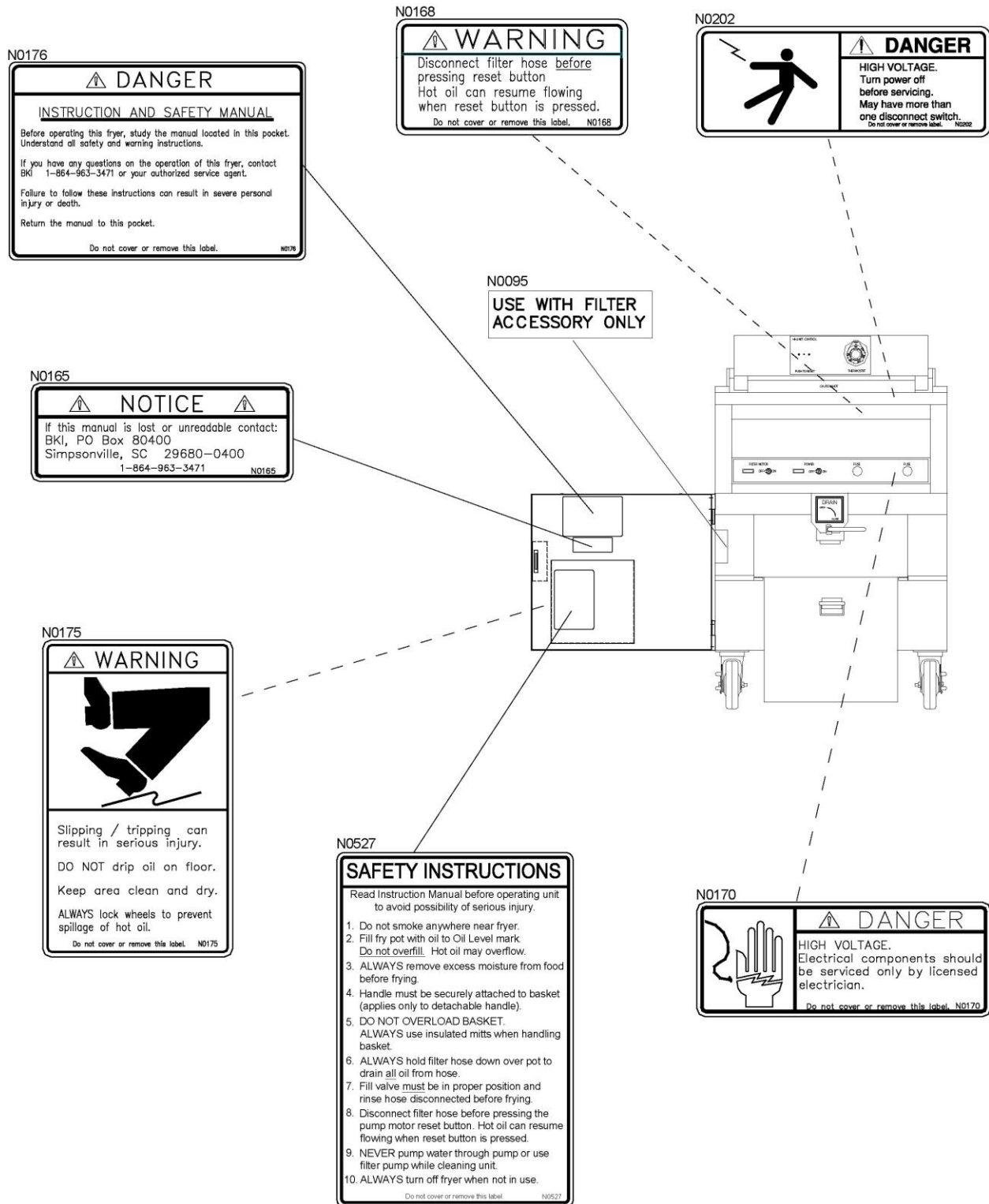

Installation

⚠ WARNING

Serious injury, equipment damage or death could result if attempting to install this fryer yourself. Ensure that an authorized BKI service agent installs the fryer.

Unpacking and Handling

It is the owners' responsibility to file all freight claims with the delivering truck line. Inspect all cartons and crates for damage as soon as they arrive. If damage to cartons or crates is found, or if a shortage is found, note this on the bill of lading (all copies) prior to signing.

If damage is found when the equipment is opened, immediately call the delivering truck line and follow up the call with a written report indicating concealed damage to your shipment. Ask for an immediate inspection of your concealed damage item. Packaging material **MUST** be retained to show the inspector from the truck line.

Assembly and Mounting

1. Remove all packing from the interior and exterior of the fryer.
2. Move the fryer to its permanent location and lock the casters so the fryer does not move. Every time you use the fryer, ensure that the casters are locked.
3. Clean the fryer vat before filling with shortening.
4. Place the DRAIN handle in the CLOSED position.
5. If you plan to cook cake doughnuts, attach the submersion screen (R0019) to the calrod shield (DNFA007).

Wiring

⚠ WARNING

Electrocution, equipment failure or property damage could result if an unlicensed electrician performs the electrical installation. Ensure that a licensed electrician perform the electrical installation in accordance with local codes, or in the absence of local codes, with the National Electrical Code, ANSI NFPA 70-20XX.

This unit, when installed by an authorized BKI service agent, must be wired for use in accordance with all applicable local, state, and federal codes. For specific electrical requirements and connections refer to the wiring diagram attached to the unit or provided in the Service Manual.

Initial Test and Adjustment

1. Fill vat with shortening to about one inch below the mark.

NOTE: A solid type vegetable shortening is recommended for frying because doughnuts tend to absorb more shortening and are heavy when fried in liquid shortening.

CAUTION

Overfilling the fryer vat with shortening could lead to serious injury. Ensure that the fryer vat is filled with shortening only to the fill mark when shortening is hot. Do not use any shortening other than what is specified in this manual and do not overfill the fryer vat.

NOTICE

Use only high-quality shortening that has low moisture content, a high smoke point and no additives.

2. Place the **POWER** switch to the **ON** position.
3. Set the thermostat to the desired temperature (best results are obtained at 370° F to 380° F). The shortening should begin to heat and begin to reach the fill mark inside the vat. Add more shortening as required to reach the fill mark. Refer to the troubleshooting section if this does not occur.

Operation

Controls and Indicators

Refer to the figure and table below for an explanation of the fryer's controls and indicators.

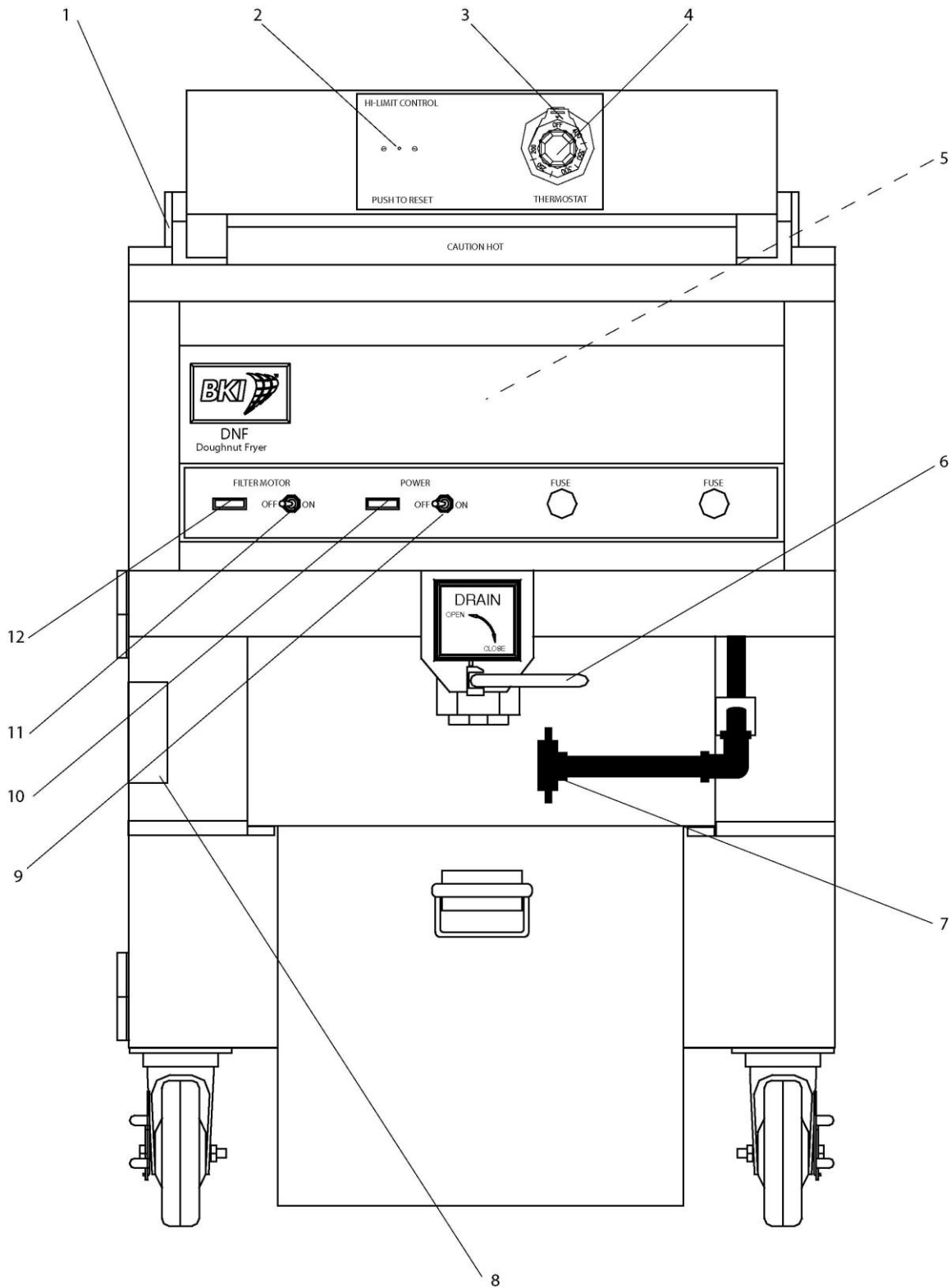

Item #	Description	Function
1	Hinge Casting	Enables you to raise and lock the Upper Control Panel (including heating elements) for cleaning the oil vat.
2	High Limit Reset Switch	If the heating elements inside the vat reach an unsafe temperature, power is automatically removed from the control panel and elements. Pressing this switch returns power to the control panel and elements.
3	Thermostat Light	Illuminates red indicating that the heating elements are activated.
4	Thermostat Knob	Used to set the temperature of the shortening.
5	Pump Motor Reset Switch (DNF-F only)	This is a red push-button switch on the end of the pump motor. If the motor overheats while filtering, it will automatically shut off. Wait 15 minutes to allow motor to cool before pressing this switch.
6	Drain Lever	DRAIN OPEN – When placed in this position, the drain valve opens and shortening in the vat drains into the oil container. Also power is removed from the control panel and elements. DRAIN CLOSED – When placed in this position, the drain valve is closed to prevent shortening from draining into the oil container.
7	Handlebar Union (DNF-F only)	Used to connect the filter screen assembly to the pump motor piping or disconnect the filter screen assembly from the pump motor piping.
8	Portable Filter Power Receptacle (DNF only)	Used to supply power to the portable filter.
9	POWER ON/OFF Switch	Used to control power to the fryer.
10	POWER ON/OFF Indicator	This light illuminates to indicate that power is being supplied to the fryer.
11	FILTER MOTOR ON/OFF Switch	Used to control power to the pump motor (DNF-F) or portable filter power receptacle (DNF). For a DNF-F, when this switch is ON, power is applied to the motor and shorting is pumped into the vat. The POWER switch must be ON in order to activate this switch.
12	FILTER MOTOR ON/OFF Indicator	This light illuminates to indicate that power is being supplied to the pump motor (DNF-F) or portable filter power receptacle (DNF).

Care of the Shortening

Solid shortening should always be returned to the filter vat while in the liquid state. If this is not done, it will have to be heated to a liquid state. When using solid shortening, the fryer must be equipped with a pump heater. After filtering with solid shortening, the filter lines must be completely emptied of shortening. The pump heater will take care of any residual shortening in the pump, but cannot melt all of the shortening in the filter lines. The pump heater accessory may be purchased separately from BKI.

To extend the life of your shortening, for the best possible flavor in your products, and for economy and efficiency of operation, we urge you to follow these recommendations:

1. Use only high-quality frying shortening without additives, of low moisture content and with a high smoke point.
2. Filter at least once a day or once every three loads during frequent cooking.
3. Clean any residue or crust formations from the sides and bottom of the vat each time you filter the shortening.
4. Add fresh shortening as needed to maintain the proper shortening level **TO THE FILL MARK ON THE VAT WALL.**
5. **DO NOT HOLD SHORTENING AT HIGH TEMPERATURE** when the fryer is not in use. If you expect an elapsed time of one hour or more between cooking, close the lid and set the thermostat to 150° F.
6. Excessive boiling and foaming are definite signs of shortening breakdown and indicate the need to replace the shortening.
7. After you have finished frying for the day, filter the shortening and replace the filter pad.
8. **IMPORTANT!** Before the first cooking operation each day, stir the shortening freely while it is heating to provide a balanced shortening temperature for excellent results with the first cooking. In addition, in some cases, failure to stir the shortening while it is initially heating may cause the HI-LIMIT safety to disable the power due to a false overshoot condition.

Start-Up

1. Make sure the main drain valve is closed.
2. Open the Drainboard and secure it in place with the Drainboard rod.
3. Fill vat with shortening to about one inch below the fill mark.

CAUTION

Overfilling the fryer vat with shortening could lead to serious injury. Ensure that the fryer vat is filled with shortening only to the fill mark when shortening is hot. Do not use any shortening other than what is specified in this manual and do not overfill the fryer vat.

4. Once the fryer is filled with shortening, place the **POWER** switch in the **ON** position.
5. Set the thermostat to the desired temperature (best results are obtained at 370° F to 380° F). The temperature light will go on. When the temperature is reached, the light will go off. The light will continue to cycle on and off as the fryer tries to maintain the set temperature.
6. The shortening should begin to heat and begin to reach the fill mark inside the vat. Add more shortening as required to reach the fill mark.

IMPORTANT! Before the first cooking operation each day, stir the shortening freely while it is heating to provide a balanced shortening temperature for excellent results with the first cooking. Failure to do this can result in an undercooked product internally. In addition, in some cases, failure to stir the shortening while it is initially heating may cause the HI-LIMIT safety to disable the power due to a false overshoot condition.

Cooking Yeast Doughnuts

1. Ensure that the Start-Up procedures have been performed.

NOTE: Use fry screens for proofing yeast raised products. Keep the fry screens clean and oily to prevent the doughnuts from sticking to the screens.

WARNING

Hot shortening may splash out of the vat causing severe injury when lowering fry screen into vat. Carefully lower fry screen into vat to prevent shortening splashes.

WARNING

Failure to use the insulated mitts will result in severe injury. Always use the insulated mitts when handling the fry screen and fry screen lifter.

2. Place a fry screen with proofed doughnuts on the fry screen lifter and slowly lower into the shortening. The doughnuts should release from the screen and float to the surface.
3. Use flip sticks for turning the doughnuts.
4. When the doughnuts are done, remove the doughnuts from the shortening by raising the screen lifter out of the shortening and placing on the drainboard.
5. Glaze the doughnuts while they are hot.
6. Remember to filter the shortening at least every 3-5 frying loads. Refer to the procedure in this manual. Also filter the shortening and clean the fryer at the end of each day. If you do not plan to use the fryer for an hour or more, turn the thermostat down to 150° F and close the lid.
7. When you have finished frying for the day, turn the **POWER** switch to the **OFF** position.

Cooking Cake Doughnuts

1. Ensure that the Start-Up procedures have been performed.

⚠ WARNING

Hot shortening may splash out of the vat causing severe injury when lowering fry screen into vat. Carefully lower fry screen into vat to prevent shortening splashes.

⚠ WARNING

Failure to use the insulated mitts will result in severe injury. Always use the insulated mitts when handling the fry screen, fry screen lifter and submersion screen.

2. Place the submersion screen in the upright position.
3. Place a fry screen on the fry screen lifter and slowly lower into the shortening.
4. Use a doughnut cutter to carefully drop doughnuts in the shortening.
5. Use flip sticks to turning the doughnuts.
6. Lower the submersion screen.
7. When the doughnuts are done, raise the submersion screen.
8. Remove the doughnuts from the shortening by raising the screen lifter out of the oil and placing on the drainboard.
9. Let the doughnuts cool for about 5 minutes before glazing.
10. Remember to filter the shortening at least every 3-5 frying loads. Refer to the procedure in this manual. Also filter the shortening and clean the fryer at the end of each day. If you do not plan to use the fryer for an hour or more, turn the thermostat down to 150° F and close the lid.
11. When you have finished frying for the day, turn the **POWER** switch to the **OFF** position.

Maintenance

⚠ CAUTION

Failure to comply with the maintenance below could result in a serious accident.

Your fryer will need periodic maintenance and servicing. We strongly suggest that you use only a service company that is authorized by BKI to do this work.

The DNF appliance is not intended to be cleaned with a water jet.

Scheduled Maintenance

Use the following table to help manage scheduled maintenance activities.

FREQUENCY	PERFORMED BY	PART	ACTIVITY
Daily	User	Filter Pad	Replace filter pad. Refer to the procedure in this manual.
	User	Filter system	Filter the shortening using the procedure in this manual.
Weekly	User	Fryer Vat	Perform the boil-out procedure in this manual.
Every 6 Months	Authorized BKI service agent	Connections, Fittings	Check for leakage while oil is pumping.

Filtering Procedure

We recommend the shortening be filtered after every 3-5 frying loads. When the shortening starts to show signs of foaming and has a bad taste, replace it. The fryer vat should be cleaned before refilling with new shortening. Best results for filtering are obtained while the shortening is hot. You should filter at the end of every business day.

WARNING

Always wear appropriate personal protection equipment during the filtering process to guard against possible injury from hot oil.

DNF-F

1. Set the **POWER** switch to **ON** and the **FILTER MOTOR** switch to **OFF**.
2. Make certain that the filter pad is clean and not torn.

IMPORTANT: Make certain the vat cover is properly positioned underneath the drain valve. Also make certain the filter vat and filter screen is under the main drain valve before starting the filtering process.

3. Move the DRAIN handle slowly to the OPEN position so that the shortening starts to flow evenly. This is to prevent excessive splashing of hot shortening.
4. When the vat is empty, place the DRAIN handle in the CLOSED position.

WARNING

Hot shortening may splash out of the vat causing severe injury when filling the vat if the lid is not closed. To prevent shortening splashes, close the lid before filling.

5. Close the lid to prevent shortening splashes.
6. Position the **FILTER MOTOR** switch to **ON**. Shortening will automatically pump into the vat.
7. After 1 minute carefully open the lid to check the level of the shortening.
8. Let the filter continue to pump the shortening until the fill mark in the fryer vat is reached or until air starts bubbling through the shortening.
9. As soon as air is seen in the shortening, position the **FILTER MOTOR** switch to **OFF** to prevent shortening degradation and prevent the filter pump and lines from filling up with shortening.
10. Add new shortening if the fill mark has not been reached.

DNF

1. Set the **POWER** switch to **ON** and the **FILTER MOTOR** switch to **OFF**.
2. Make certain that the FKF filter unit or portable filter unit filter pad is clean and not torn.
3. Position the FKF filter unit or portable filter unit under the main drain valve and make sure it's filter screen is in place.
4. Ensure that the FKF filter unit or portable filter unit is plugged into the filter power receptacle.
5. Move the DRAIN handle slowly to the OPEN position until the shortening starts to flow evenly. This will prevent excessive splashing of hot shortening.
6. When the vat is empty, place the DRAIN handle in the CLOSED position.
7. Make certain that the rinse hose is connected to it's mating part on the FKF filter unit or portable filter unit.
8. Holding the hose by the handle, place hose nozzle inside the vat.

⚠ WARNING

Hot shortening may splash out of the vat causing severe injury when filling the vat if the lid is not held down over the hose nozzle. To prevent shortening splashes, hold the lid down over the hose nozzle.

9. Hold the lid down over the hose nozzle to prevent shortening splashes.
10. Position the **FILTER MOTOR** switch to **ON** and shortening will automatically pump into the vat.
11. After 1 minute, hold the hose by the handle and carefully raise the lid to check the level of the shortening.
12. Let the filter continue to pump the shortening until the fill mark in the fryer vat is reached or until air starts bubbling through the shortening.
13. As soon as air is seen in the shortening, position the **FILTER MOTOR** switch to **OFF** to prevent shortening degradation.
14. Add new shortening if the fill mark has not been reached.

Boil-Out Procedure

Boil-outs remove microscopic particles of carbon that build up on the walls of the fryer vat. To avoid eventual carbon build-up, off flavors, and shortening breakdown, boil-outs should be done once a week on each fryer following these procedures.

⚠ WARNING

Always wear appropriate personal protection equipment during the boil-out process to guard against possible injury from hot cleaning solution.

1. Position the **POWER** switch to **OFF**.
2. Drain the clean shortening into an adequate storage container. (**Allow the shortening to cool to room temperature before attempting storage.**)

-
3. CLOSE the drain and fill the fryer vat with **HOT** water to the shortening level fill mark. Do not overfill by allowing the water level higher than the fill mark.
 4. Add ½ cup (4 ounces) of **BKI** cleaner.
 5. Wash down the inside of the vat and lid with a vat brush to loosen the sediment.
 6. Position the **POWER** switch to **ON**.
 7. Set the thermostat to a temperature of 190° F.
 8. Bring the cleaning solution to a rolling boil and maintain the boil for 5 minutes.
 9. Place the **POWER** switch to **OFF**.
 10. Scrub the inside of the fryer vat.
 11. **Before draining the cleaning solution**, remove the filter bag, screen and pipe connections from the filter vat. This must be done before draining the cleaning solution.

NEVER pump water or detergent through the filter system.

12. After 15 minutes, slowly open the drain valve. Drain the solution into the filter vat and discard.
13. Rinse the vat with hot water, using the vat brush to remove remaining sediment, drain and discard.
14. Close the drain and refill the fryer vat with hot water to the proper level.
15. Add approximately 4 to 6 ounces of distilled (white) vinegar to develop a neutralizing solution. Stir the solution briefly. Leave in the vat for three to five minutes and discard.

NOTE: Foaming of shortening after boil-outs is caused by failure to follow proper neutralizing procedures.

16. Repeat above steps as needed to remove all traces of cleaning solution.
17. Rinse the vat again with Cool water, drain and discard.

CAUTION

Damage to the fryer could result if the fryer vat is not completely dry before filling with shortening. Refill the fryer vat with shortening **ONLY** when it is completely dry.

18. Dry the fryer vat, lid, and filter vat **COMPLETELY**.
19. Close the main drain and fill with new shortening to the proper level.

Filter Pad Replacement

The filter pad must be replaced daily. If the shortening has a milky color when it is pumped into the vat, the filter pad should be replaced immediately.

CAUTION

If the filter pad is not properly closed, breading crumbs will get through the pad opening and clog the pump. Ensure that the filter pad is properly closed upon replacement.

1. Place the filter screen inside the filter pad.
2. Fold the end of the pad and seal with the bag clip.

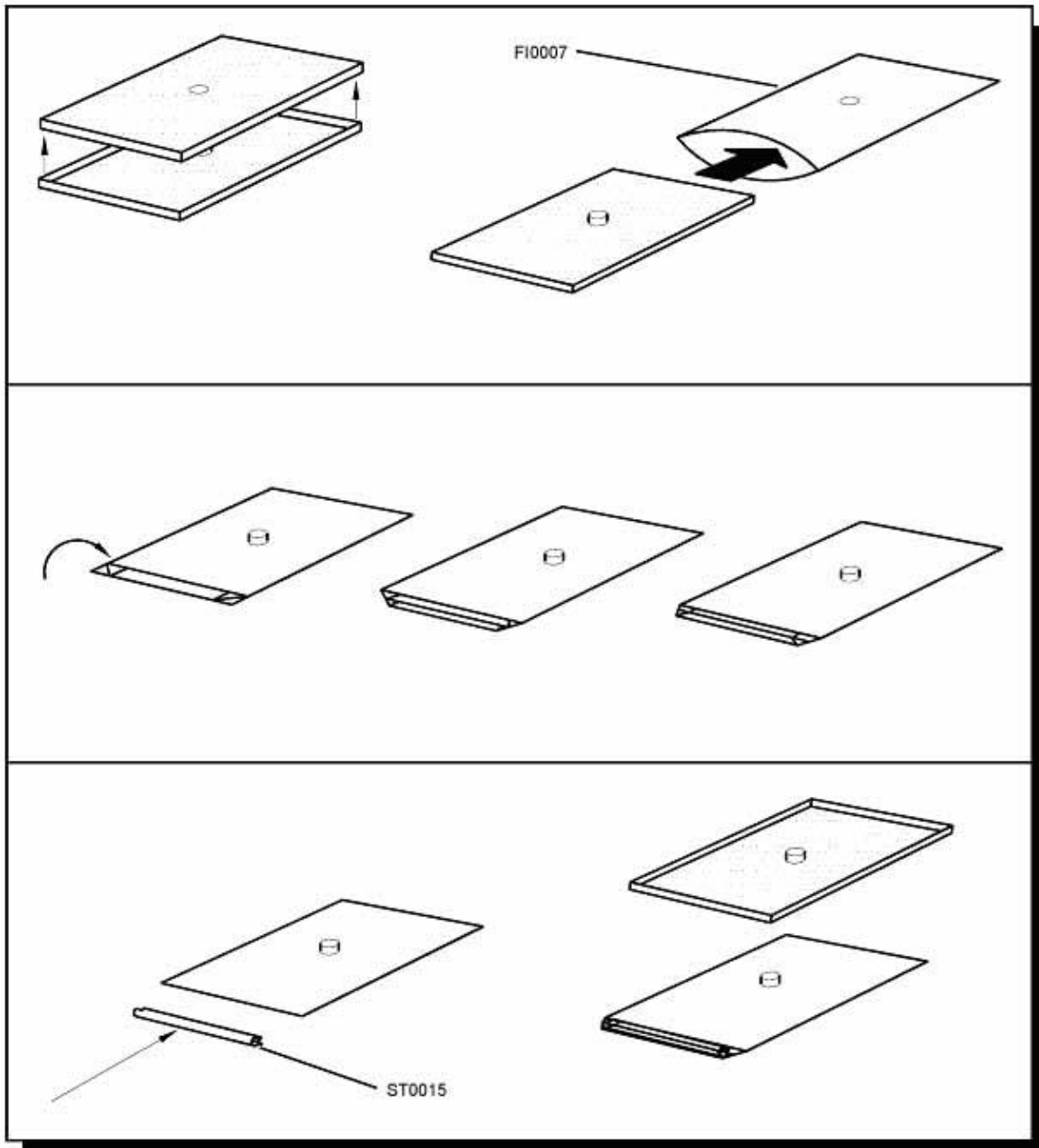

Troubleshooting

Refer to the table below for troubleshooting information.

Problem	Cause	Possible Solution
Shortening Heating Too Slowly	Low voltage or improper voltage	Contact an authorized BKI service agent for corrective action.
	Bad thermostat or loose wires	Contact an authorized BKI service agent for corrective action.
	Weak heating elements or heating elements breaking down	Contact an authorized BKI service agent for corrective action.
	Coil on contactor is bad	Contact an authorized BKI service agent for corrective action.
Filter System Not Working	Uncertain	Press the reset button on end of pump and hi-limit reset button on control panel. If problems persist, contact an authorized BKI service agent for corrective action.
	Connections not tight	Tighten the connections. If problems persist, contact an authorized BKI service agent for corrective action.
	Filter valve not open	Contact an authorized BKI service agent for corrective action.
	Filter paper on screen clogged with crumbs	Change filter paper. If problems persist, contact an authorized BKI service agent for corrective action.
	Motor hums, but does not pump	Check for clogged pump. If problems persist, contact an authorized BKI service agent for corrective action.
	Motor and pump coupling worn	Contact an authorized BKI service agent for corrective action.
	No power to control panel	Make sure drain valve is completely closed. If problems persist, contact an authorized BKI service agent for corrective action.



2812 Grandview Dr., Simpsonville, S.C. 29680, USA
<http://www.bkideas.com>

Made and printed in the U.S.A.

SS-OM-020.02

Revised 10/16/18