

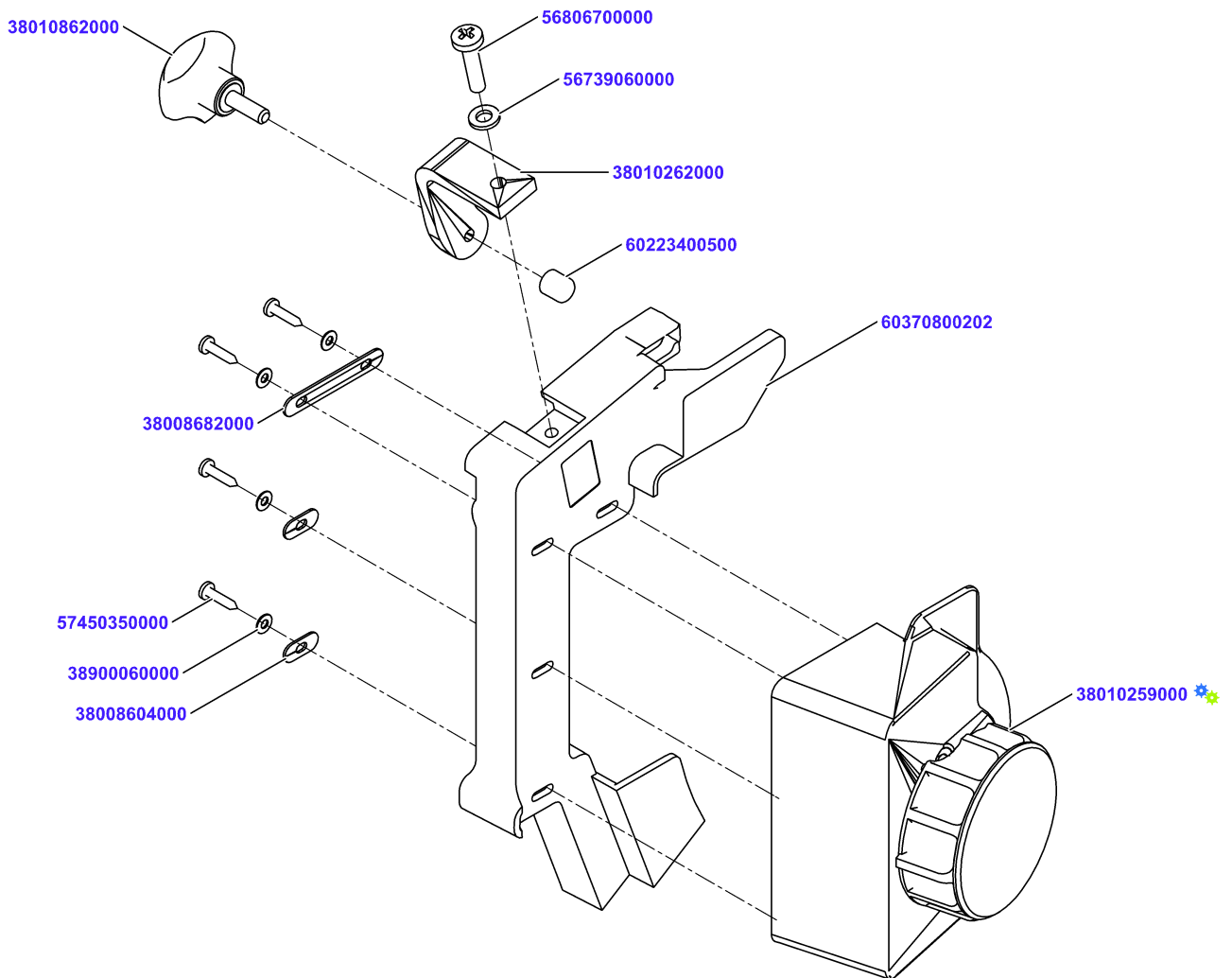









# Grinder GSP 330 cpl. 18/25 High



# Grinder GSP 330 cpl. 18/25 High

Item	Material No.	Qty	Material description	available for order	Wear part	Recomm. sp. part	Metr. relevance
	38010259000	1	UVV Sharpener preass. GSP				
	60370800202	1	adapter USA 18/25 H				
	38008604000	2	Cover disc 18x8				
	38008682000	1	cover disc long				
	57450350000	4	Self-tap screw ISO7049-C3,5x16 A2-50-T15				
	38900060000	4	Washer DIN125-A-3,5-A2				
	38010262000	1	tightening element				
	<a href="#">56806700000</a>	1	Oval-head screw DIN7985 M6x25-A2-70				
	56739060000	1	Washer DIN125-A-6-A2				
	38010862000	1	Steel star handle 18,85mm, cpl.				
	60223400500	1	Cap M6x10	