



Donut Production Equipment

www.belshaw.com

Operator's Manual
TECHNICAL SUPPLEMENT
Operator's Manual
Parts & Electrical Diagrams

Year of manufacture

2022

Models:

H18F • HI24F

Donut Icer



Electronic Temperature Controller

ITEM NUMBER

SERIAL NUMBER

*Item Number and Serial Number are marked on a data tag attached to the equipment.
This manual should only be used with the Item Number(s) shown above.*



DECLARATION OF CONFORMITY INSIDE

SUPPORT

USA/Canada 1-800-BELSHAW
International (+1) 206-322-5474

Email service@belshaw.com
Web www.belshaw.com

Belshaw®



High Production Donut Icer

HI18F • HI24F

Operator's Manual

Belshaw 814 44TH St NW Suite 103, Auburn WA 98001 USA

Phone: 1-800-BELSHAW (US/Canada) ☐ +1 (206) 322-5474 (International)

Email: service@belshaw.com ☐ www.belshaw.com

Ref: MNOM-HI1824-prov0202mb-070722

BELSHAW FREIGHT DAMAGE POLICY

Belshaw has made every effort to insure that your equipment arrives in excellent condition. **For your protection**, please inspect your shipment for any signs of damage that may have occurred during transport. Please note any damage that is found during inspection and file a freight claim with the shipping company immediately. Acceptance of damaged equipment may become the responsibility of the acceptor.

IMPORTANT
Keep This Manual For Future Reference.



EQUIPMENT RECORD

Please provide the information below when you correspond with us about your machine.

Purchased by _____

Installed by _____

Date of installation _____ Model number _____

Serial number _____

Part # MN-1747EN

Belshaw

814 44TH St NW Suite 103, Auburn WA 98001 USA

Phone: 1-800-BELSHAW (US/Canada) 1 (206) 322-5474 (International)

Email: service@belshaw.com www.belshaw.com

Belshaw

• www.belshaw.com

2

HI18/HI24 Icer • Operator's Manual

SUPPORT • 1.800.BELSHAW (+1)206.322.5474 service@belshaw.com

Contents - Operator's Manual

Contents - Operator's Manual	3
Before You Start	4
1 Operation	5
Main Parts of the HI18/24 Icer	5
The Temperature Probe	5
Inserting and Heating the Icing	6
Icing Donuts	7
2 Cleaning	10
3 Maintenance	13
Lubrication	13

TECHNICAL SUPPLEMENT -

- Located after Operator's Manual
- Printed separately for CE / Europe / Australia / NZ manuals

Before You Start

The **HI18/HI24 Icer** is designed for quickly and easily icing donuts and other baking products.

The **HI18/HI24 Icer** is meant to be used on a flat, stationary surface. The operator must work safely at all times and follow the instructions and warnings in this manual.

The **HI18/HI24 Icer** uses electrical elements to heat frosting. The machine may have the following configurations:

- ✓ 120 volts, 1 phase, 60 hertz
- ✓ 208-240 volts, 1 phase, 60 hertz

The **HI18/HI24 Icer** produces less than 70 dB(A) of equivalent continuous A-weighted sound pressure at work stations. This has been determined using a Bruel & Kjaer sound level meter, type 2236.

To use the **HI18/HI24 Icer** safely, follow these warnings:

- ⚠ UNPLUG the machine before attempting any adjustment, repair, disassembly, or cleaning to avoid electrocution or other injury.
- ⚠ NEVER USE force to assemble, disassemble, operate, clean, or maintain the machine.
- ⚠ To prevent unintentional startup and possible fire, UNPLUG the machine if there is a local power outage. When the power is

restored, it is safe to plug the machine in again.

- ⚠ MAKE SURE that all electrical cords are routed so that no one will trip over them.
- ⚠ To avoid electrocution, MAKE SURE that no electrical cords are frayed or cracked and that they do not pass through any water or icing.
- ⚠ NEVER TOUCH the icing pan once the machine is on. The pan gets very hot, which may cause serious burns.
- ⚠ DO NOT OVERFILL the icing pan. If icing spills out, it could cause serious burns or could cause someone to slip on the floor and be seriously injured.
- ⚠ MAKE SURE that the machine and the icing are cool before attempting any adjustment, repair, disassembly, or cleaning. Hot icing can cause serious burns.
- ⚠ BE CAREFUL never to get icing, water, or other materials on the floor. If anything does get spilled on the floor, mop it up immediately. Materials on the floor can cause people to slip or fall, resulting in serious injury or loss of life.

1 Operation

Main Parts of the HI18/24 Icer

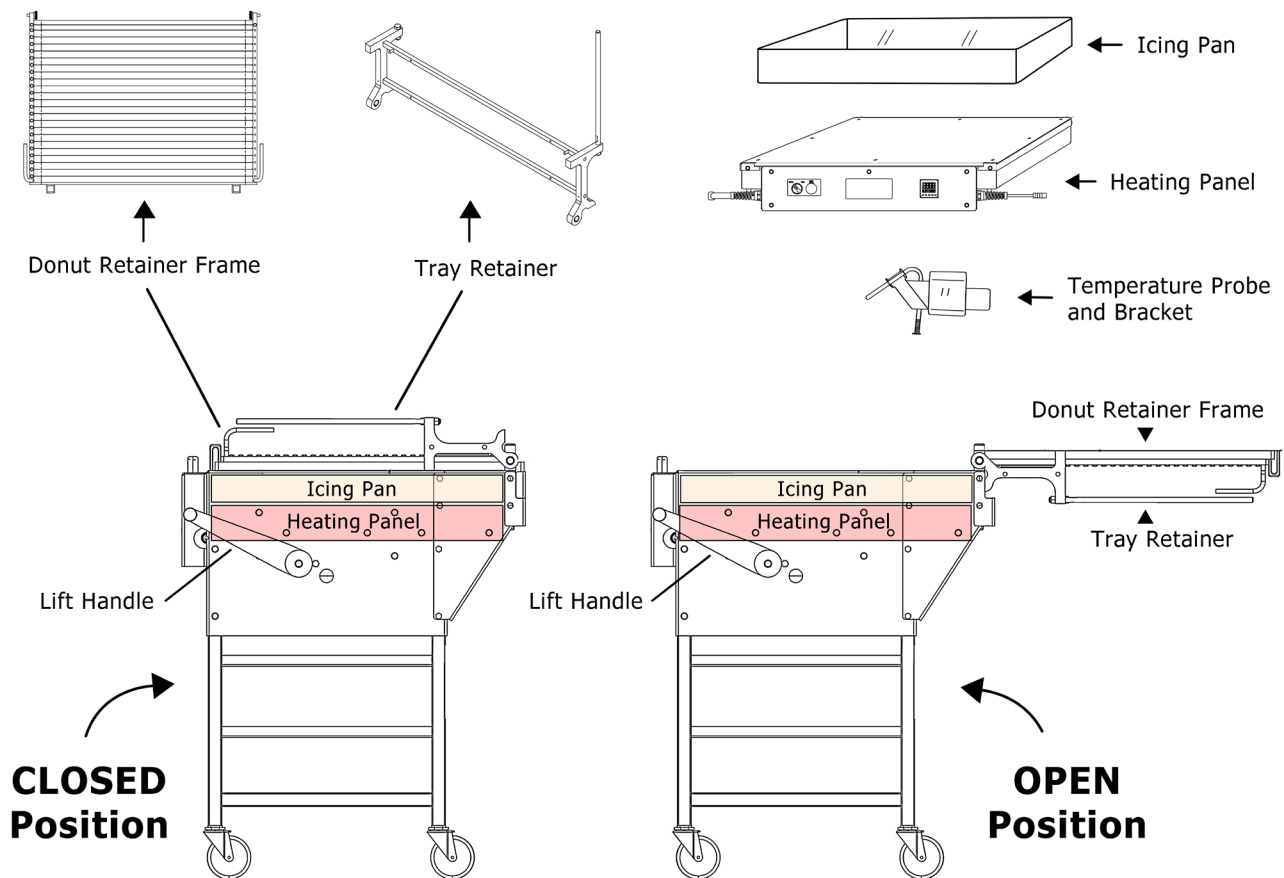

Figure 1: Main parts of the HI18/24 Icer showing OPEN and CLOSED position

The Temperature Probe

The Temperature Probe is housed in a bracket which clips to the back of the Icing Pan. (Figure 2)

MAKE SURE that the Temperature Probe is in place when icing donuts.

It should be taken out for cleaning, and whenever the Icing Pan is removed.

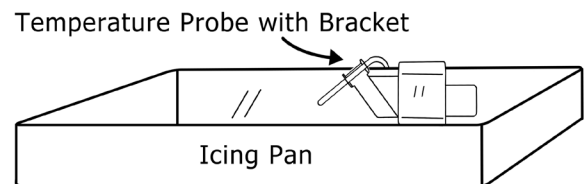

Figure 2: Temperature Probe and Bracket

Inserting and Heating the Icing

1. LIFT the **Tray Retainer** and rotate it to the back of the icer. This is the OPEN position (See Figure 1).
2. LIFT the **Donut Retainer Frame** and rotate it to the OPEN position as well. (The Donut Retainer frame has attached wires).
3. FILL the **Icing Pan** with icing. Leave at least 1/2" (13 mm) empty space to the top of the pan. (Figure 3)



Figure 3: Full Icing Pan.

4. CONNECT the Icer plug to your power source.
5. TURN ON the green **Heater Switch**.
The Electronic Temperature Controller will display:
 - Current Temperature (white)
 - Target Temperature (green)

(Figure 4)



Figure 4: Electronic Temperature Controller

6. ALLOW time for the icing to reach the target temperature. The yellow **Heating Indicator Light** is ON while heating and OFF when the target temperature is reached.
7. STIR the icing in the **Icing Pan** regularly with a Spatula to ensure constant, even heating of the icing.
8. You are now ready to ice a screen (or tray) of donuts.

Icing Donuts

1. ROTATE the **Donut Retainer Frame** to the CLOSED position. Leave the Tray Retainer in the OPEN position.(Figure 5)



Figure 5: Ready to ice donuts.

2. Insert a screen with donuts into the **Tray Retainer** (Figure 6)



Figure 6: Insert donuts on screen or tray.

3. ROTATE the **Donut Retainer Frame** back so that the wires are on top of the donuts. (Figure 7)



Figure 7: Wires are in contact with donuts.

4. GRIP the two handles at once, and rotate the **Tray Retainer** and the **Donut Retainer Frame** back into the CLOSED position. (Figure 8)

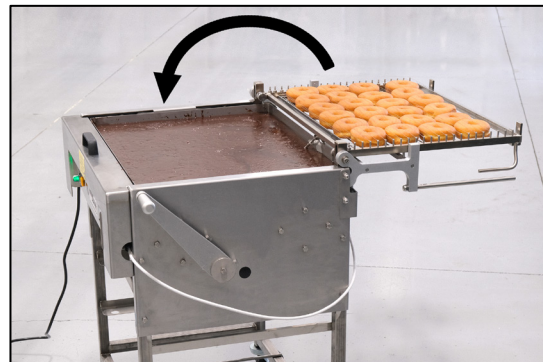

Figure 8: Rotate to CLOSED position.

5. The donuts should now be directly above the icing pan. (Figure 9)



Figure 9: Place Donuts over icing pan.

6. Rotate the **Tray Retainer** (with screen or tray in place) back to the OPEN position. (Figure 10)

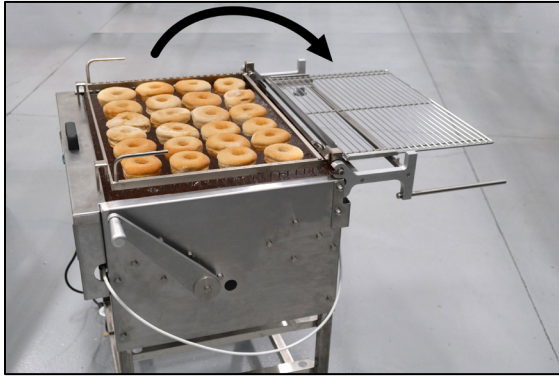

Fig. 10: Tray Retainer in OPEN position.

7. PUSH DOWN the **Lift Handle**. This raises the **Icing Pan** and dips the bottom of the donuts in icing. (Figure 11)



Figure 11: Push down on the Lift Handle to ice donuts

- Using the **Lift Handle**, RAISE AND LOWER the Icing Pan as many times as necessary for the icing to stick to the donuts.
8. ROTATE the **Donut Retainer Frame** (with screen or tray in place) back into the CLOSED position. (Figure 12).

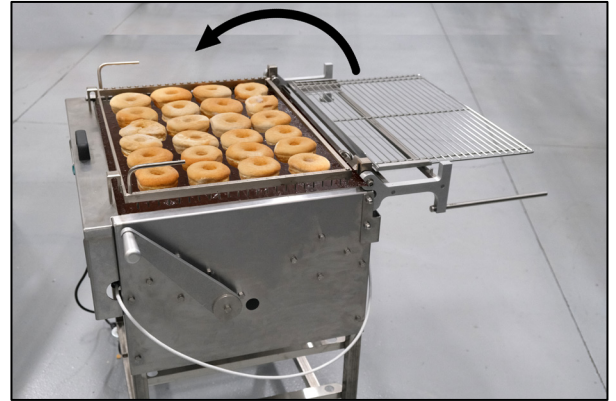

Figure 12: Rotate the Donut Retainer Frame back into the CLOSED position.

- The Icer should now look as shown in Figure 13 below.

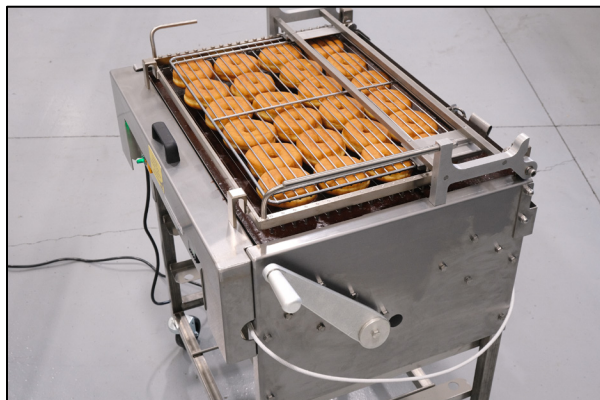

Figure 13: Donut Retainer Frame.

- ROTATE the **Tray Retainer** and the **Donut Retainer Frame** (together with the iced donuts) into the OPEN position. (Figure 14).

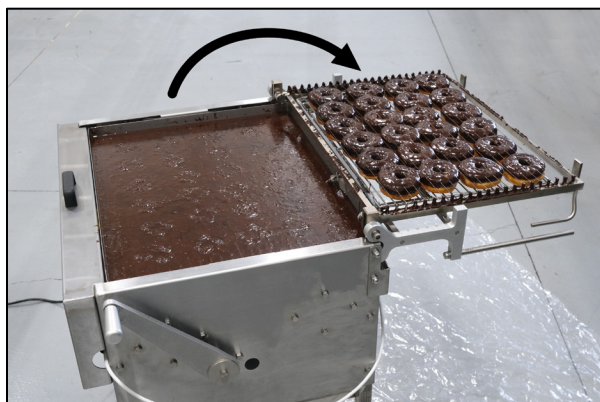

Figure 14: Rotate into the OPEN position.

- SHAKE the handles if you need to reduce the amount of icing on the donuts.

- ROTATE the **Donut Retainer Frame** (without the iced donuts) into the CLOSED position over the Icing Pan. (Figure 15)



Figure 15: Rotate the Donut Retainer frame to CLOSED position.

- REMOVE the screen or tray of iced donuts. (Figure 16)



Figure 16: Remove the screen or tray of donuts.

- Repeat steps 1-11.

After you have repeated these steps a few times, this detailed description will no longer be necessary.

2 Cleaning



FOR YOUR SAFETY!

WARNING!

- THOROUGHLY CLEAN AND DRY the floor if icing, water, or other materials are spilled. Materials spilled on the floor can cause serious injury or loss of life.



- To avoid the possibility of shock, **UNPLUG THE ICER** before cleaning.



- **DO NOT** wash the **Heating Panel** with running water! Use a damp cloth only.



- To avoid damage to the wires of the **Donut Retainer Frame**, **USE CAUTION** when moving and cleaning.



Once a day, clean the **HI18/HI24 Icer** as explained below:

1. REMOVE any debris from the work area before cleaning the icer.
2. REMOVE the **Temperature Probe** and **Bracket** from the **Icing Pan**. CLEAN and SANITIZE with a damp cloth.

NOTE: The **Connecting Cable** of the Temperature Probe **CAN NOT** be removed from the Heating Panel.

Temperature Probe with Bracket

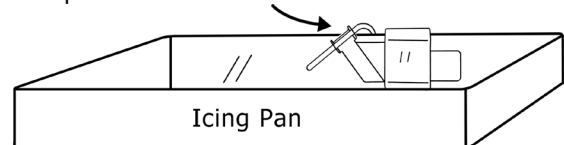

3. OPEN the Front Panel of the icer. LIFT the handle, then PULL it toward you. (See diagram below.)

Opening the front panel

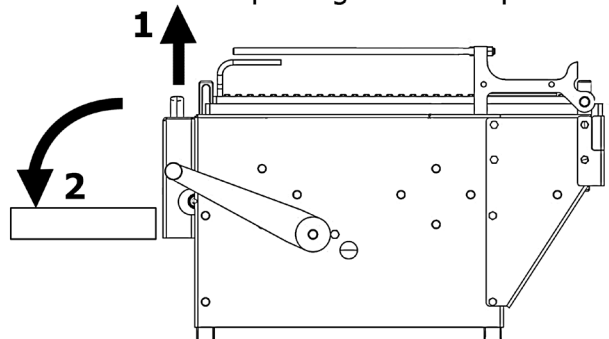

4. To avoid being burned, WAIT for the **Icing Pan** to cool. Then REMOVE the **Icing Pan**. WASH and SANITIZE thoroughly.

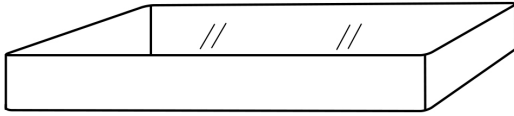

Icing Pan

5. UNPLUG AND REMOVE the **Heating Panel** from the Icer. CLEAN the **Heating Panel** with a damp cloth.

DO NOT WASH the Heating Panel with running water!

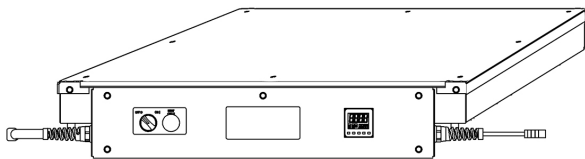

Heating Panel

6. CLEAN the remaining parts of the **HI18/HI24 Icer** with warm water and mild cleaner.

7. ROTATE the **Tray Retainer** to the open position. Wash with warm soapy water, rinse, and wipe dry.

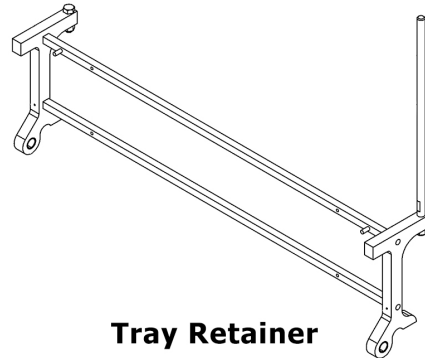

Tray Retainer

8. UNSCREW the **Retainer Knobs** that hold the **Donut Retainer Frame** in place and lift it out. It is best to wash the **Donut Retainer Frame** in an automatic panwasher. USE CAUTION so that the wires do not get damaged.

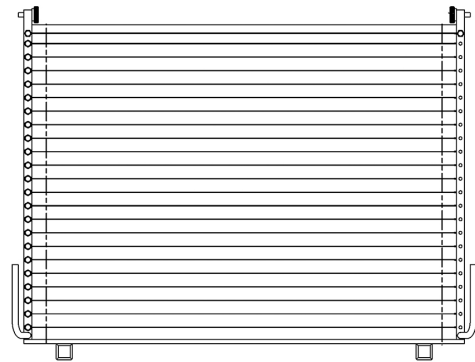

Donut Retainer Frame

9. When the **Icing Pan** and **Heating Panel** are dry, REPLACE them in the Icer. Leave in the OPEN position until the Front Panel is closed.

10. CLOSE the **Front Panel** of the icer.

IMPORTANT: Ensure that both cords leading from the **Heating Panel** fit through the **holes on each side of the Front Panel.** (see photos below)



The Icer is now ready for use.

3 Maintenance

Lubrication

WARNING



To avoid serious burns or other injury, always disconnect the machine from the power source before lubricating.

Use only Food Grade Lubricating Oil.
Belshaw recommends and approves ONLY Lubriplate FMO-900-AW.

1. ONCE A WEEK:
Apply 3 drops of Lubriplate FMO-900-AW oil to the **Pivot Pins** on each side of the **Tray Retainer** and the **Donut Retainer Frame**.
2. EVERY TWO WEEKS:
Apply 3 drops of Lubriplate FMO-900-AW oil to the **Lift Handle Axle**, located under the heating panel.

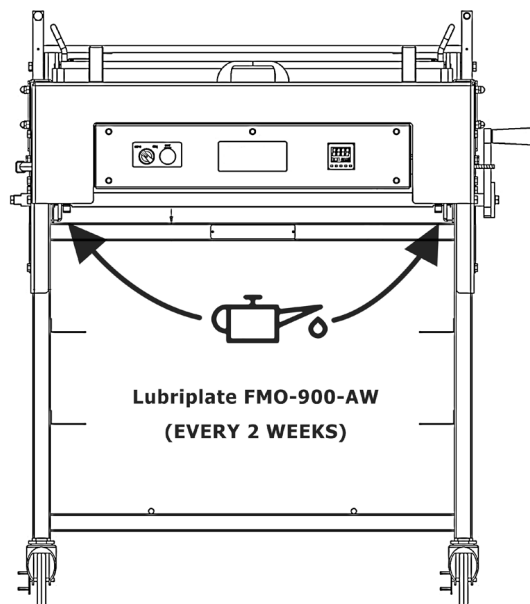
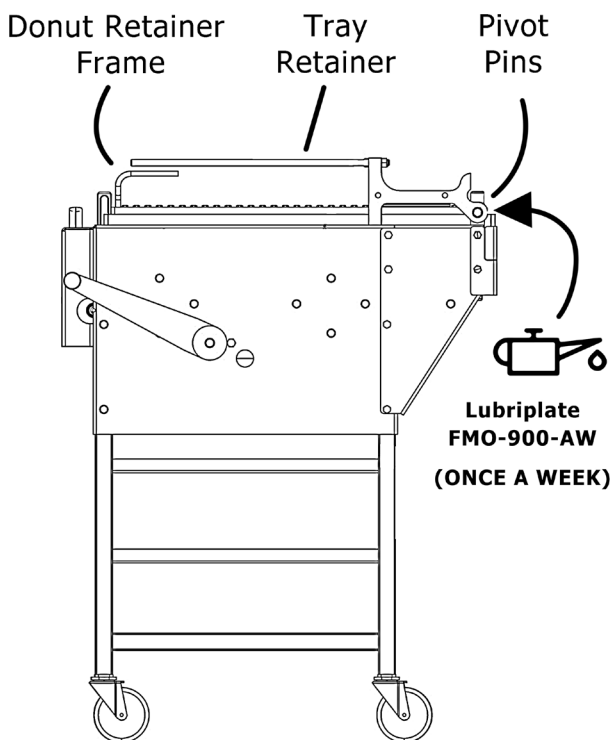

Belshaw[®]



High Production Donut Icer

HI18F • HI24F

Technical Supplement

Belshaw 814 44TH St NW Suite 103, Auburn WA 98001 USA

Phone: 1-800-BELSHAW (US/Canada) +1 (206) 322-5474 (International)

Email: service@belshaw.com www.belshaw.com

Contents – Technical Supplement

Contents - Technical Supplement	2
IMPORTANT	3
1 Using the HI18 icer with Baking Pans.....	5
To install the replacement Tray Holders for Baking Pans:.....	5
2 Converting the HI18/24 Icer for Left Hand operation.....	6
Step 1: Move the Lift Handle to the left side.	6
Step 2: Move the Tray Retainer Handle to the left side	6
3 Maintenance	7
Wire Tensioning and Replacement.....	7
2 Programming the Temperature Controller	9
Unlocking the Controller	9
Changing Operator Set Points.....	10
Changing Operator Level Parameters.....	11
Changing Initial Level Parameters	11
Changing Advanced Level Parameters	12
Locking the Controller	13
Setting the Controller to Default Settings	13
3 Troubleshooting.....	14
Troubleshooting Specifics	15

OPERATOR'S MANUAL -

- Located before Technical Supplement
- Printed separately for CE / Europe / Australia / NZ manuals

IMPORTANT

The **HI18/HI24 Icer** is designed for quickly and easily icing donuts and other baking products.

The **HI18/HI24 Icer** is meant to be used on a flat, stationary surface. The operator must work safely at all times and follow the instructions and warnings in this manual.

The **HI18/HI24 Icer** uses electrical elements to heat frosting. The machine may have the following configurations:

- ✓ 120 volts, 1 phase, 60 hertz
- ✓ 208-240 volts, 1 phase, 60 hertz

The **HI18/HI24 Icer** produces less than 70 dB(A) of equivalent continuous A-weighted sound pressure at work stations. This has been determined using a Bruel & Kjaer sound level meter, type 2236.

To use the **HI18/HI24 Icer** safely, follow these warnings:

- ⚠ UNPLUG the machine before attempting any adjustment, repair, disassembly, or cleaning to avoid electrocution or other injury.
- ⚠ NEVER USE force to assemble, disassemble, operate, clean, or maintain the machine.
- ⚠ To prevent unintentional startup and possible fire, UNPLUG the machine if there is a local power outage. When the power is

restored, it is safe to plug the machine in again.

- ⚠ MAKE SURE that all electrical cords are routed so that no one will trip over them.
- ⚠ To avoid electrocution, MAKE SURE that no electrical cords are frayed or cracked and that they do not pass through any water or icing.
- ⚠ NEVER TOUCH the icing pan once the machine is on. The pan gets very hot, which may cause serious burns.
- ⚠ DO NOT OVERFILL the icing pan. If icing spills out, it could cause serious burns or could cause someone to slip on the floor and be seriously injured.
- ⚠ MAKE SURE that the machine and the icing are cool before attempting any adjustment, repair, disassembly, or cleaning. Hot icing can cause serious burns.
- ⚠ BE CAREFUL never to get icing, water, or other materials on the floor. If anything does get spilled on the floor, mop it up immediately. Materials on the floor can cause people to slip or fall, resulting in serious injury or loss of life.

- ⚠ To avoid electrocution, MAKE SURE that all electrical cords are not frayed or cracked and that they do not pass through any water or icing.
- ⚠ NEVER TOUCH the icing pan once the machine is on. The pan gets very hot, which may cause serious burns.
- ⚠ DO NOT OVERFILL the icing pan with icing. If shortening overflows the icing pan, it could cause serious burns or could cause someone to slip on the floor and be seriously injured.
- ⚠ MAKE SURE that the machine and the icing are cool before attempting any adjustment, repair, disassembly, or cleaning. Hot icing can cause serious burns.
- ⚠ BE CAREFUL never to get icing, water, or other materials on the floor. If anything does get spilled on the floor, mop it up immediately. Materials on the floor can cause people to slip or fall, resulting in serious injury or loss of life.

1 Changing between Baking Pans and Donut Screens

HI18 Icers are supplied with two sets of **Tray Holders**.

- The small **Tray Holders** are pre-installed. They are for use with **Glazing Screens**, Part# SL200-0004. (Figure 1).



Figure 1: *Belshaw Glazing Screen.*

- The large **Tray Holders** are for use with 18 x 26 inch **Baking Pans**.



Figure 2: *Baking Pan.*

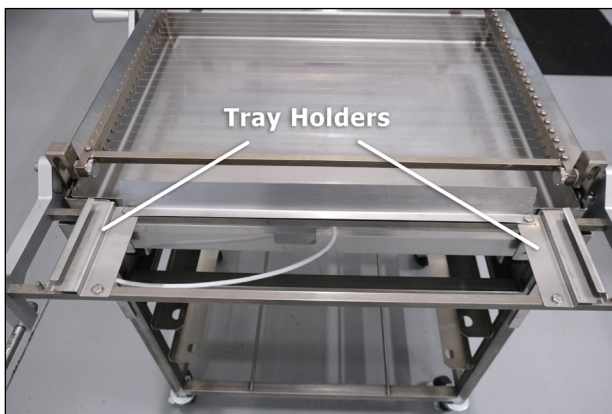

Figure 3: *Small Tray Holders for screens.*

To change Tray Holders between Screens and Baking Pans:

1. Using a 7/16" wrench, LOOSEN AND REMOVE the 2 bolts holding each **Tray Holder** in position (Figure 2).

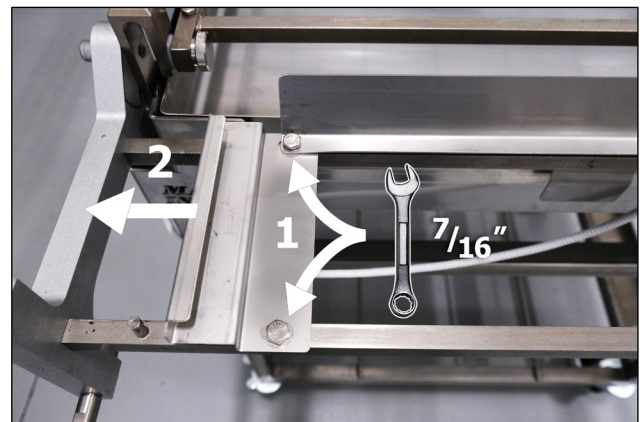

Figure 2: *Removing the Tray Holder (a small Tray Holder is shown).*

2. REPLACE both Tray Holders with the alternate set of **Tray Holders**.
3. CHECK that your screens or baking pans will fit easily into the new set of **Tray Holders**. The Positioning of the Tray Holders can be ADJUSTED as needed.
4. Tighten all 4 bolts holding the **Tray Holders** in position.

2 Converting the HI18/24 Icer for Left Hand operation.

- The HI18/24 Icer can be converted for use with the Lift Handle on the left side (Left Hand operation). This conversion may take up to 30 minutes.
- You can also obtain a second Lift Handle by ordering Part# SK-1683 , to operate the icer from both sides.

Step 1: Move the Lift Handle to the left side.

1. Using a 3/8" wrench, undo the bolt securing the Lift Handle in place. (Figure 3)



Figure 3: Removing the Lift Handle.

2. REMOVE the Lift Handle, Bolt and Washer.
3. PLACE them on the Lift Axle on the opposite side.
4. TIGHTEN the Bolt.

Step 2: Move the Tray Retainer Handle to the left side

1. Using a 3/8" wrench, LOOSEN the Lock Nut that holds the **Tray Retainer Handle** in place. You will need an adjustable wrench to hold the handle while you do this. (Figure 4)

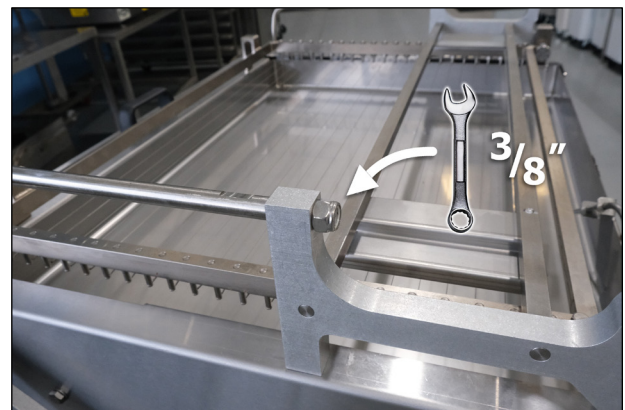

Figure 4: Removing the Tray Retainer Handle.

2. Move the handle to the left side and secure with the same Lock Nut. (Figure 4)

The Icer is now ready for operation.

3 Maintenance

Wire Tensioning and Replacement.

The following tools are required for wire tensioning and replacement:

- ✓ 5/16" Open-End Wrench
- ✓ Wire Cutter



IMPORTANT

Do not use a box wrench to tighten. This will cause too much torque, and the frame may bend and bow.



Figure 1: *Looped end of wire*

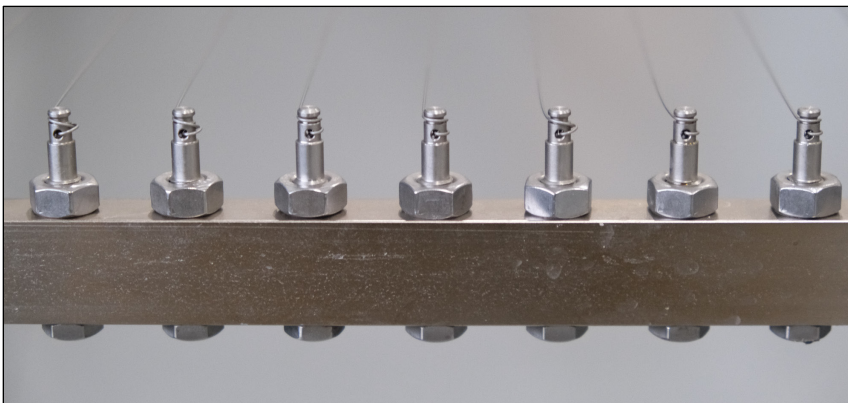

Figure 2: *Twisted end of wire*

1. PLACE the looped end of the new wire over the **Wire Retainer Pin** and place it in the groove. (Figure 1)
2. TWIST the open end of the wire two times around the **Wire Adjusting Pin**, then THREAD the end of the wire through the hole. (Figure 2)

3. With the 5/16" open-end wrench, LOOSEN the bolt on the side OPPOSITE to the wires.
4. With the 5/16" open-end wrench, TURN the **Wiring Adjusting Pin** that holds the wire. This will tighten the wire. Be sure the wire winds in the groove of the pin.
 - a. TIGHTEN the wire until taut, removing all slack.

IMPORTANT!
Do Not Over Tighten! Over Tightening Will Cause The Frame To Bend And Bow.

5. TIGHTEN the bolt on the side OPPOSITE to the wires.
6. TRIM the end of wire with wire cutters.

4 Programming the Temperature Controller

The **TJ-0184D-1 or 2 Controller** comes per-programmed and protected so the operator cannot change the setup parameters. To change any settings, you must first unlock the **Controller**.

Note: Only the settings that are changed from the factory settings are listed in this section.

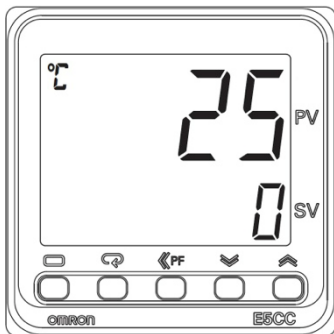

Unlocking the Controller





To unlock the controller:

1. PRESS the + **keys** for more than 3 seconds.
2. PRESS the **key** to move to the next parameter.
3. PRESS the **or** to change the parameter $\overline{\text{dRPL}}$ and $\overline{\text{LCPLE}}$ from 2 to 0.
4. PRESS the + **keys** for more than 1 second to return to operator screen.

PARAMETER	FACTORY DEFAULT SETTING	PRESENT SETTING	UNIT	FRONT PANEL	EXPLANATION OF PRESENT SETTING
Protection Parameters					
Operation/Adjustment Protect	0	2	.	OPPL	2:Display and change of only "PV" and "PV/SP" parameters are allowed. [2]
Initial Setting/Communications Protect	1	2	.	ICPL	2:Prohibited. [2]

Changing Operator Set Points





To change operator set points: (Must be unlocked to change Alarm Value 1.)

1. PRESS the  **key** to move to the next parameter.
2. PRESS the  **or**  **key** to change the parameter.
3. PRESS the  **key** to return to operator screen.

PARAMETER	FACTORY DEFAULT SETTING	PRESENT SETTING	UNIT	FRONT PANEL	EXPLANATION OF PRESENT SETTING
Operator Set Points					
Set Point	0.0	125.0/50.0	°F/°C	.	.
Alarm Value 1	0.0	10.0/5.0	°F/°C	AL - 1	.

Changing Operator Level Parameters





To change operator level parameters:
(Must be unlocked.)

1. PRESS the  **key** for less than 1 second.
2. PRESS the  **key** to move to the next parameter.
3. PRESS the  **or**  **key** to change the parameter.
4. PRESS the  **key** to return to operator screen.

PARAMETER	FACTORY DEFAULT SETTING	PRESENT SETTING	UNIT	FRONT PANEL	EXPLANATION OF PRESENT SETTING
Operator Level Parameters					
Process Value Input Shift	0.0	0.0	°F/°C	LN5	This is the offset setting for calibration.
Hysteresis (Heating)	1.0	0.5	°F/°C	H45	.

Changing Initial Level Parameters





To change initial level parameters:
(Must be unlocked.)

1. PRESS the  **key** for more than 1 second to adjust initial parameters.
2. PRESS the  **key** to move to the next parameter.
3. PRESS the  **or**  **key** to change the parameter.
4. PRESS the  **key** for more than 1 second return to operator screen.

PARAMETER	FACTORY DEFAULT SETTING	PRESENT SETTING	UNIT	FRONT PANEL	EXPLANATION OF PRESENT SETTING
Initial Level Parameters					
Input Type	5	8	.	IN-E	8: Thermocouple [J] (-20.0 to 400.0°C or 0.0 to 750.0°F) [8]
Temperature Unit	0	1	.	D-U	°F [F]
SP Upper Limit	130.0	150.0/65.0	°F/°C	SL-H	.
SP Lower Limit	-20.0	0.0	°F/°C	SL-L	.
Alarm 2 Type	2	0	.	ALt2	0: Alarm function OFF [0]
Alarm 3 Type	2	0	.	ALt3	0: Alarm function OFF [0]
Alarm 4 Type	2	0	.	ALt4	0: Alarm function OFF [0]

Changing Advanced Level Parameters







To change advanced level parameters: (Must be unlocked.)

1. UNLOCK the controller.
2. PRESS the  **key** for more than 1 second to adjust initial parameters.
3. PRESS the  **key** until you get to parameter *RM \bar{a} V*.
4. PRESS the  **or**  key to change *RM \bar{a} V* parameter to -169.

PARAMETER	FACTORY DEFAULT SETTING	PRESENT SETTING	UNIT	FRONT PANEL	EXPLANATION OF PRESENT SETTING
Advanced Level Parameters					
Alarm 1 Latch	0	1	.	<i>ALt</i>	Enabled [<i>oN</i>]
PV/SP No. 1 Display Selection	4	1	.	<i>SPd1</i>	1:"PV/SP/No display" [1]
PV Decimal Point Display	1	0	.	<i>PVdP</i>	OFF [<i>oFF</i>]







Locking the Controller

After programming: To lock the controller:

1. PRESS the  +  **keys** for more than 3 seconds.
2. PRESS the  **key** to move to the next parameter.
3. PRESS the  **or**  **key** to change the parameter *oAPt* and *iLPL* from 0 to 2.
4. PRESS the  +  **keys** for more than 1 second to return to operator screen.

Setting the Controller to Default Settings

To set the controller back to factory default settings: (Must be unlocked.)

1. PRESS the  **key** for more than 1 second to adjust initial parameters.
2. PRESS the  **key** until you get to **parameter** *AMoV*.
3. PRESS the  **or**  **key** to change *AMoV* **parameter** to - **169**.
4. CHANGE **parameter** *iNtL* from *oFF* to *FACt*.
5. PRESS the  **key** for more than 1 second to return to initial screen.
6. PRESS the  **key** for more than 1 second to return to operator screen.

5 Troubleshooting

If you have a problem with your **HI18/HI24 Econo-Icer** that you cannot solve, call your dealer or another qualified technician.

If your dealer cannot help you, please call Belshaw at 800-578-2547 or email service@belshaw.com.

When you call, please specify:

- ✓ The MODEL NAME of the machine.
- ✓ The ITEM NUMBER of the machine.
- ✓ The SERIAL NUMBER of the machine.
- ✓ The VOLTAGE, PHASE, and CYCLE of the machine.

CAUTION

IF YOU PERFORM REPAIRS YOURSELF, OR HAVE THEM PERFORMED BY ANYONE OTHER THAN A SERVICE TECHNICIAN AUTHORIZED BY BELSHAW ADAMATIC, YOU DO SO AT YOUR OWN RISK.



DISCONNECT THE MACHINE FROM THE POWER SOURCE BEFORE DISASSEMBLING, REPAIRING, OR WIRING.



Troubleshooting Specifics

NO HEAT AND ON/OFF SWITCH DOES NOT LIGHT UP	
Possible Causes	What To Do
Unit not plugged in or wall electrical breaker is tripped.	Plug unit in and/or check electrical outlet.
ON/OFF SWITCH ON AND LIT UP, HEATING LIGHT NOT ON	
Possible Causes	What To Do
Loose wire.	Check wires.
NO HEAT, ON/OFF SWITCH ON AND LIT UP, HEATING LIGHT ON	
Possible Causes	What To Do
Heating element failure.	Check heating element of open circuit.
Relay failure.	Check if relay turns on; replace if defective.
UNEVEN ICING TEMPERATURE.	
Possible Causes	What To Do
Icing needs stirring.	Stir icing.
WIRES ARE NOT EVENLY TAUT	
Possible Causes	What To Do
Wires are not evenly adjusted.	Tighten loose wires.
NO HEAT, ON/OFF SWITCH ON AND LIT UP, HEATING LIGHT NOT ON	
Possible Causes	What To Do
Loose wire.	Check wires.
High limit tripped.	Wait 10 minutes and recheck.
Temperature controller set too low.	Adjust set point higher.
Thermocouple not plugged in.	Plug thermocouple into connector.