



INSTALLATION
AND
OPERATING
INSTRUCTIONS

Gas Char-Broilers.....MODELS: GCB-18i, -24i, -36i, -48i
&

Gas CharRock Broilers..... MODELS: GCRB-18i, -24i, -36i, 48i

IMPORTANT FOR FUTURE REFERENCE

Please complete this information and retain this manual for the life of the equipment. For Warranty Service and/or Parts, this information is required.

_____ Model Number

_____ Serial Number

_____ Date Purchased



FOR YOUR SAFETY: Do not store or use gasoline or other flammable vapors and liquids in the vicinity of this or any other appliance.



WARNING: Improper installation, operation, service or maintenance can cause property damage, injury or death. Read and understand these instructions thoroughly before positioning, installing, maintaining or servicing this equipment.



WARNING: Instructions must be posted in a prominent location. All safety precautions must be taken in the event the user smells gas. Safety information can be obtained from your local gas supplier.





P/N 882201



APW WYOTT Foodservice Equipment Company



P.O. Box 1829
Cheyenne, WY 82003



+1 (307) 634-5801 Phone
+1 (307) 637-8071 Fax

+1 (800) 752-0863 Toll Free
www.apwwyott.com

 **CAUTION:** These models are designed, built, and sold for commercial use. If these models are positioned so the general public can use the equipment, make sure that cautions, warnings, and operating instructions are clearly posted near each unit so that anyone using the equipment will use it correctly and not injure themselves or harm the equipment. 

 **WARNING:** Improper installation, adjustment, alteration, service or maintenance can cause property damage, injury or death. Read the installation, operating and maintenance instructions thoroughly before installing or servicing this equipment. 



 **WARNING:** For your safety do not store or use gasoline or other flammable vapors and liquids in the vicinity of this or any other appliance. Keep the area free and clear of combustibles. (See ANZI Z83. 14B, 1991). 

 **NOTICE:** Instructions to be followed if anyone smells gas should be posted in a prominent place. These may be obtained from the gas supplier. 

GAS PRESSURE

The appliance and it's individual shutoff valve (to be supplied by user) must be disconnected from the gas supply piping system during any pressure testing of that system at test pressures in excess of ½ psi (3.45 kPa).

The appliance must be isolated from the gas supply piping system by closing it's individual manual shut-off valve during any pressure testing of the gas supply piping system at test pressures equal to or less than ½ psi (3.45 kPa).

 **WARNING:** A factory authorized agent should handle all maintenance and repair. Before doing any maintenance or repair, contact APW Wyott. 

Congratulations on your purchase of APW Wyott commercial cooking or refrigeration equipment. APW Wyott takes pride in the design and quality of our products. When used as intended and with proper care and maintenance, you will experience years of reliable operation from this equipment. To ensure best results, it is important that you read and follow the instructions in this manual carefully.

TABLE OF CONTENTS

ITEM	PAGE	ITEM	PAGE
Safety Precautions	3	Cleaning/Maintenance	9
General Installation Instructions.....	4	Service/Repair	10
Specifications & Dimensions.....	4	Troubleshooting Guide	11
Conversion	7	Replacement Parts Lists & Exploded Views	12
Lighting Instructions	7	Warranty.....	21
Operation Instructions	9		

LOCATION OF DATA PLATE

The data plate is located on the rear panel.

IMMEDIATELY INSPECT FOR SHIPPING DAMAGE

All containers should be examined for damage before and during unloading. The freight carrier has assumed responsibility for its safe transit and delivery. If equipment is received damaged, either apparent or concealed, a claim must be made with the delivering carrier.

- A) Apparent damage or loss must be noted on the freight bill at the time of delivery. It must then be signed by the carrier representative (Driver). If this is not done, the carrier may refuse the claim. The carrier can supply the necessary forms.
- B) Concealed damage or loss if not apparent until after equipment is uncrated, a request for inspection must be made to the carrier within 15 days. The carrier should arrange an inspection. Be certain to hold all contents and packaging material.

Installation and start-up should be performed by a qualified installer who thoroughly read, understands and follows these instructions.

If you have questions concerning the installation, operation, maintenance or service of this product, write Technical Service Department APW Wyott Foodservice Equipment Company, P.O. Box 1829, Cheyenne, WY 82003.

SAFETY PRECAUTIONS



DANGER: This symbol warns of imminent hazard which will result in serious injury or death.



WARNING: This symbol refers to a potential hazard or unsafe practice, which could result in serious injury or death.



CAUTION: This symbol refers to a potential hazard or unsafe practice, which may result in minor or moderate injury or product or property damage.



NOTICE: This symbol refers to information that needs special attention or must be fully understood even though not dangerous.



NOTICE: This product is intended for commercial use only. Not for household use.



CAUTION: These models are designed, built, and sold for commercial use. If these models are positioned so the general public can use the equipment make sure that cautions, warnings, and operating instructions are clearly posted near each unit so that anyone using the equipment will use it correctly and not injure themselves or harm the equipment.



WARNING: Improper installation, operation, service or maintenance can cause property damage, injury or death. Read and understand these instructions thoroughly before positioning, installing, maintaining or servicing this equipment.



NOTICE: Local codes regarding installation vary greatly from one area to another. The National Fire Protection Association, Inc., states in its NFPA96 latest edition that local codes are "Authority Having Jurisdiction" when it comes to requirement for installation of equipment. Therefore, installation should comply with all local codes.



GENERAL INSTALLATION INSTRUCTIONS

Ensure gas supply and gas type, as shown on unit nameplate, agree.

Unit installation must conform with the National Fuel Gas Code, ANSI Z223.1/NFPA 54, the National Gas Installation Code, CSA-B149.1, or the Propane Installation Code, CSA-B149.2 as applicable and in accordance with local codes.

Screw legs into the permanently fastened nuts on the four corners of the unit and tighten by hand. Level the unit by turning the adjustment screw at the bottom of each leg. Do not slide unit with legs mounted, lift if necessary to move unit.

Pipe threading compound must be resistant to the action of liquefied petroleum gases.

Caution: DO NOT use an open flame to check for leaks. Check all gas piping for leaks with a soap and water solution before operating unit.

THESE UNITS ARE SUITABLE FOR INSTALLATION ON NON-COMBUSTIBLE SURFACES ONLY.

Noncombustible clearances:

0" sides (0 mm) 0" rear (0 mm) 4" floor (102mm)

Do not obstruct the flow of combustion and ventilation air, under the unit by the legs or behind the unit by the flue.

Adequate clearance for air openings into the combustion chamber is required. Do not place objects between the bottom of the unit and the counter top.

There must be adequate clearance for removal of the front panel. All major parts except the burners are removable thru the front if the gas line is disconnected.

Unit must have adequate clearances for servicing. (Sides = 0", Rear = 0", Floor = 4").

European Community Installation Instructions:

"THIS APPLIANCE MUST BE FITTED BY A COMPETENT PERSON. IN THE UK, CORGI REGISTERED INSTALLERS (INCLUDING THE REGIONS OF BRITISH GAS) UNDERTAKE TO WORK TO SAFE AND SATISFACTORY STANDARDS. THIS APPLIANCE MUST BE INSTALLED IN ACCORDANCE WITH THE GAS SAFETY (INSTALLATION AND USE) REGULATIONS AND THE RELEVANT BUILDING REGULATIONS / IEE. REGULATIONS. DETAILED RECOMMENDATIONS ARE CONTAINED IN THE FOLLOWING BRITISH STANDARD CODES OF PRACTICE -BS 6172, BS 5440 PART 2, BS 6891"

"THIS APPLIANCE MUST BE INSTALLED IN ACCORDANCE WITH THE RULES IN FORCE"

"MUST BE INSTALLED IN A WELL VENTILATED AREA. Ventilation requirements ie. B.S. 5440."

SPECIFICATIONS AND DIMENSIONS

MODEL	A IN. (MM)	B IN. (MM)	C IN. (MM)	D IN. (MM)	# OF BURNERS	BTU/kW PER BURNER NATURAL GAS	TOTAL BTU/kW HOUR	W.C. IN.('Mbar')
GCB-18i	18 (457)	24.1 (639)	15.6 (396)	9.0 (229)	1	60,000/17.5	60,000/17.5	6/10(15/25)
GCB-24i	24 (610)	24.1 (639)	15.6 (396)	8.6 (219)	2	40,000/11.7	80,000/23.5	6/10(15/25)
GCB-36i	36 (914)	24.1 (639)	15.6 (396)	9.6 (243)	3	40,000/11.7	120,000/35	6/10(15/25)
GCB-48i	48 (1219)	24.1 (639)	15.6 (396)	10.6 (269)	4	40,000/11.7	160,000/46.8	6/10(15/25)
GCRB-18i	18 (457)	24.1 (639)	15.6 (396)	9.0 (229)	1	60,000/17.5	60,000/17.5	6/10(15/25)
GCRB-24i	24 (610)	24.1 (639)	15.6 (396)	8.6 (219)	2	40,000/11.7	80,000/23.5	6/10(15/25)
GCRB-36i	36 (914)	24.1 (639)	15.6 (396)	9.6 (243)	3	40,000/11.7	120,000/35	6/10(15/25)
GCRB-48i	48 (1219)	24.1 (639)	15.6 (396)	10.6 (269)	4	40,000/11.7	160,000/46.8	6/10(15/25)

DIMENSIONS:

GCB-18i & GCRB-18i

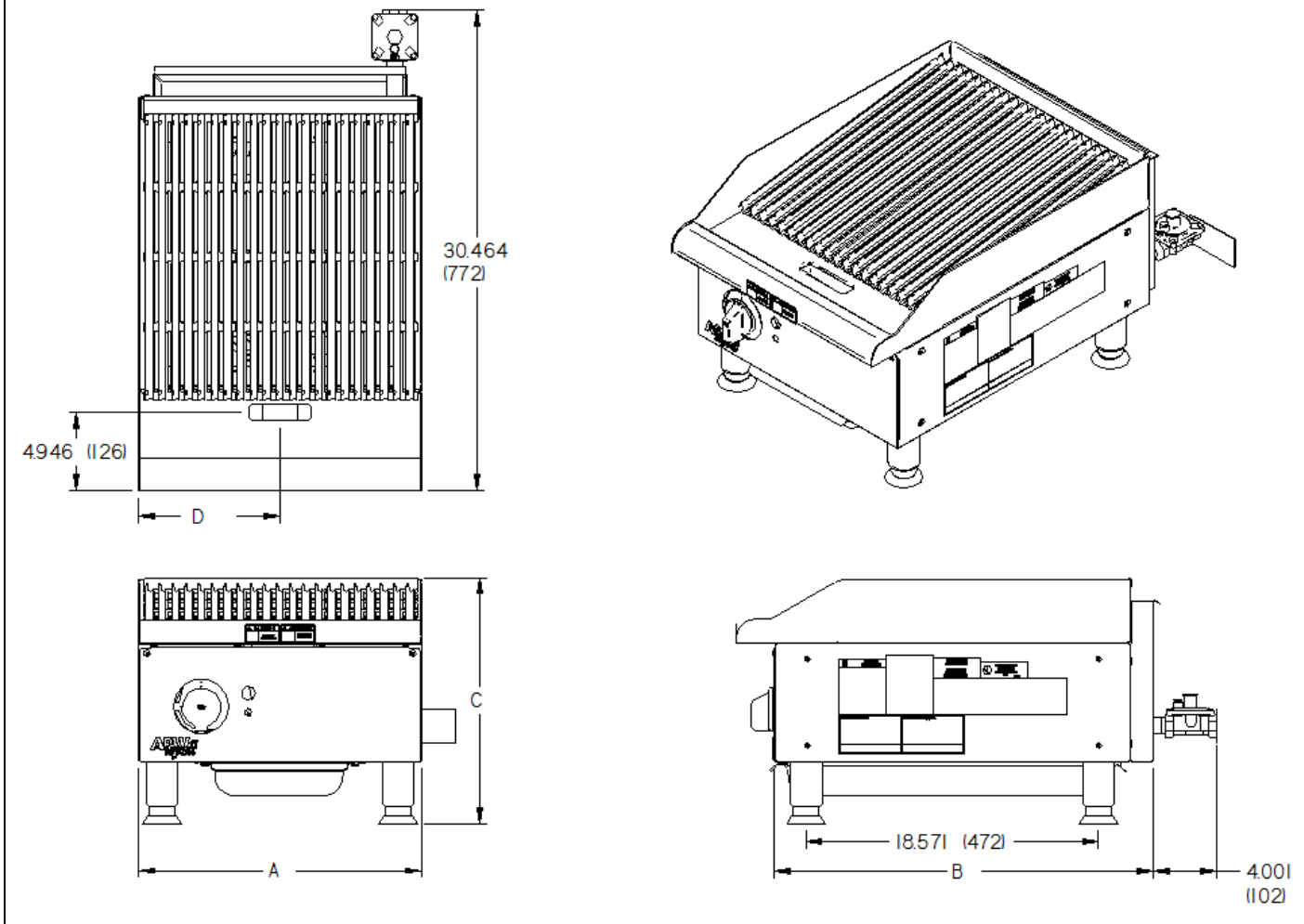

CONVERSION

- Instructions are for conversion from Natural Gas to Propane (L.P.) on all models GCRB and GCB.
 - The conversion should be done before connecting the unit to the gas supply.
 - Units are shipped from the factory equipped for use on natural gas. Orifices necessary for LP (propane) are provided in a bag tied to the valve on the front panel.
1. Remove the knobs and front panel.
 2. Remove the orifice fittings from the valve. Change the orifices to the size recommended for propane (L.P.).
 3. Replace the orifice fittings into the valve.
 4. Remove cap, invert the insert and replace cap. **NOTE:** Marking on insert.
 5. Continue with the installation.

LIGHTING INSTRUCTIONS

GCB and GCRB Broilers are furnished with either a pilot safety valve or a standing pilot (not available in the European Community). Please follow the instructions for your unit.

Pilot Safety Valve Lighting Instructions

Lighting instructions are on the right side panel.

If the pilot goes out, an automatic shutoff valve turns off the gas supply to the burners. To relight the pilot, follow this procedure:

- Turn the control valve to "OFF". Wait a sufficient length of time to allow gas, which may have accumulated in the burner compartment, to escape (at least five minutes).
- Turn on the main shutoff valve.
- Depress and hold in the red button "A" on the automatic shutoff valve while lighting the pilot burner.
- When gas at pilot has been burning for about 45 seconds, release the red button. If pilot does not remain lit, repeat the operation, allowing more time before releasing red reset button. The button can be accessed through an opening in the front panel.
- To adjust the pilot flame, Rotate the knob clockwise to reduce the gas flow, and counterclockwise to increase the gas flow; to provide a properly sized pilot flame (approximately 1/2" to 3/4" long). (12 to 19 mm)
- All units are equipped with fixed orifices for use with natural gas, and no adjustment is necessary.
- Units for operation on natural or propane gas, are also equipped with a factory preset pressure regulator with an outlet pressure of 6.0" W.C. (15 'mbar') for natural gas supply, and 10" W.C. (25 'mbar') for propane gas supply, and should not require further adjustment.

Standing Pilot Lighting Instructions (Not Available in the European Community)

The pilot lights on the broilers have been set at the factory. A screwdriver may be required for the first lighting to adjust the flame for your elevation.

1. Turn off the manual shut off valve and wait 5 minutes to clear the gas.
2. Turn all knobs to the "OFF" position.
3. Turn the manual shut off valve on.
4. Hold an ignition source (match) at the pilot. When the flame is established, remove the ignition source.
5. Turn the burner knobs to "HI". If the burner does not ignite, promptly open the pilot valve more. If the pilot flame appears larger than necessary, turn it down and reset burner ignition. The pilot flame should be as small as possible but large enough to guarantee reliable ignition of the burners when the knobs are turned to "HI".

RELIGHTING PILOT

If the pilot light should go out for any reason:

- Promptly shut off all gas at the manual shut off valve.
- Turn off all knobs and pilot valves; wait 5minutes to clear gas.
- Relight following steps 4 through 6 under **Standing Pilot Lighting Instructions**.

LIGHTING MAIN BURNER:

Since the burner is lit from constantly burning pilot, turn knobs to "HI" to put the unit in operation; then adjust to any desired position between "LO" and "HI".

- To light burner, turn knob to "max". Then back off to the desired flame level. The range of adjustment is virtually infinite between high and off. (At the small flame, there is a pre-set low).
- When the broiler is first heated, it will smoke until oil used in manufacturing, preservation and dust from storage and shipping are burned off. An hour at "max". On all burners is usually sufficient.
- Turn knobs off and let cool.
- For first cooking, set the grates at maximum tilt position and preheat before broiling. You will have to experiment with knob settings and grate position for each particular item.
- Keep the grease/water pan with sufficient water to cover the entire bottom.

- Clean regularly. Grates may be removed for washing in the sink. Brush out carbonized particles. Thoroughly wash the grease/water pan.

CAUTION

Never attempt to move a grill section while cooking. An unexpected flare could cause severe injury. Turn off the unit, let it cool and use potholders and/or gloves to reposition or remove. The space between the legs at the bottom admits combustion air. **DO NOT BLOCK THIS SPACE.**

Main burner air supply:

For efficient burner operation, a proper balance of gas volume and primary air supply must be maintained which will result in complete combustion. Insufficient air supply results in a yellow streaming flame. Primary air supply is controlled by an air shutter on the front of the burner.

Loosen the screws on the front of the burner, and adjust the air shutter to just eliminate the yellow tips of the burner flame. Lock the air shutter in place by tightening the screws.

European Community

If adjustment becomes necessary in the field, it should be done by a factory authorized and trained technician who should seal the screw after the adjustment to safeguard against unauthorized tampering by the end user.

All burners are lit from constantly burning pilots. Turning the thermostat to the desired temperature is all that is required to put the unit in service.

Do not permit fans to blow directly at the unit. Wherever possible, avoid open windows next to the units' sides or back. Avoid wall type fans which create air cross-currents within a room.

It is also necessary that sufficient air should be allowed to enter the room to compensate for the amount of air removed by any ventilating system. Otherwise, a subnormal atmospheric pressure will occur, which will effect operation and cause undesirable working conditions.

A properly designed and installed hood will act as the heart of the ventilating system for the room or area in which the unit is installed and will leave the unit independent of changing draft conditions.

All valves must be checked and lubricated periodically. This must be done by an authorized service representative in your area.

OPERATING INSTRUCTIONS

OPERATION:

Turn the burners on about 15-20 minutes before cooking for preheating. Set the knobs to the desired flame height or temperature. Each valve will control the gas flow to the burner to bring that area of the plate up to the set temperature. If different temperature settings are to be used, adjoining areas should be set at progressively higher temperatures using the lowest temperatures on the outside burners. A uniform and systematic approach to the loading of the griddle will produce the most consistent product results.

RADIANTS

Place the radiant's in their position as shown in Sketch 1. Make sure that the radiants are setting properly into the slots on the front and rear supports. Radiants should be centered over straight section of the burners.

COOKING GRATES

Place the top cooking grates with the grid bars sloping toward the front as shown in Sketch 2.

NOTE: When cooking grates are placed sloping toward the front, the grooves on top will guide the excess fat drippings into the grease trough.

SKETCH 1

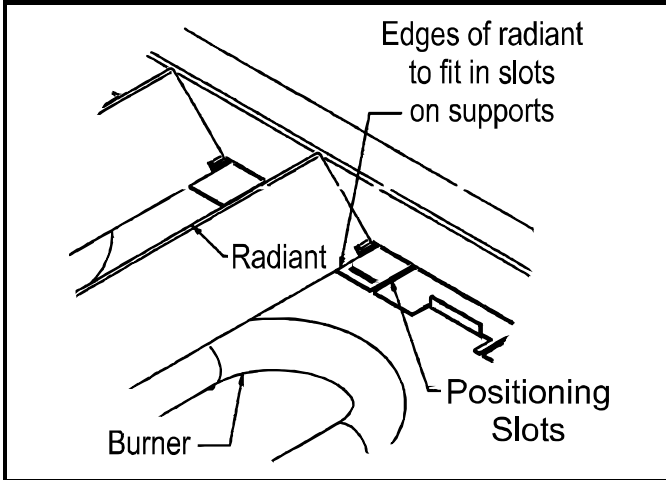

SKETCH 2

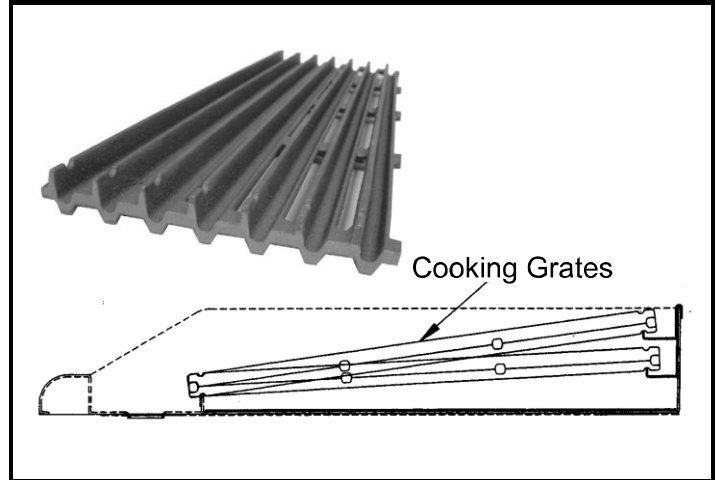

CLEANING / MAINTENANCE

INITIAL CLEANING:

Prior to operating your new broiler, thoroughly wash the exterior with a mild detergent or soap solution. Do not use abrasive cleaners, since this might damage the cabinet finish. If the stainless steel surfaces become discolored, scrub by rubbing only in the direction of the finished grain.

When the broiler is first heated, it will smoke until oil used in manufacturing, preservation and dust from storage and shipping are burned off. An hour at "max." on all burners is usually sufficient.

CLEANING:

DAILY

Remove the grease pan, empty and wash it.

Grate "burn off". The grease buildup on the grates should be cleaned daily (more often as needed).

- A. **Caution:** When handling grates or radiants, always use insulated gloves to prevent burns.
- B. **Warning:** Do not cover the top of the grid grates during a burn off operation. Restricting the airflow by covering the grid grates may cause them to warp. It will also cause damage to the valves, the knobs and the front panel decal.
- C. Place grates on broiler, with grid bars horizontal, facing down.
- D. Turn control knobs to "HI" for approximately 45minutes.
- E. Turn off the broiler and allow it to cool for 20Minutes.
- F. Clean top and bottom surfaces of grate with a wire brush to remove animal fats and carbonized grease.
- G. Clean channels on grates with a scraper.
- H. Remove grates from broiler. Clean top surface of radiant's with the wire brush. They may be cleaned in place.

WEEKLY

Thoroughly clean the exposed surfaces of broiler, sides, front and top grease trough, with a damp cloth, then polish with a soft, dry cloth. A detergent may be used for cleaning. To remove discoloration, use a nonabrasive cleaner.

After performing daily cleaning procedures, proceed with the following:

- A. Remove the radiants. Clean reflecting drip shield of any dust or debris with a brush.

Note: Top grid grates and rock grates are heavy.

- B. Burner air shutter openings must be kept clean.

- C. Burner ports must be kept clean. To clean burners, boil them in a strong solution of lye water for fifteen to twenty minutes. Then, either brush with a wire brush or clean gas ports with a sharp pointed metal instrument to insure open ports.



CAUTION: Clean the regulator at least once a month. Make sure the vent opening is open and not blocked in any way. Failure to do so will cause variations in pressure. Your unit will not function as well and it could shorten the life of the product



EXTENDED SHUTDOWN:

Turn the manual shutoff valve to "OFF"; (field installed valve not supplied by the manufacturer); turn all control knobs to the "OFF" position; and shut off the pilot flame by turning the adjustment on the pilot valve.

SERVICE / REPAIR

NOTE: THIS APPLIANCE MUST ONLY BE SERVICED BY AN AUTHORIZED AGENT.

NOTE: Parts protected by the manufacturer or his agent are not to be adjusted by the installer unless the installer is an authorized service agent.

TROUBLE SHOOTING GUIDE

PROBLEM	POSSIBLE CAUSE
Heat does not come on when valve is turned on.	Pilot burner not lit.
	Gas valve is bad.
Pilot burner will not light.	Obstructed pilot orifice.
	Pilot gas turned off at automatic pilot.
	Automatic pilot valve is bad.
Pilot burner will not stay lit.	Thermocouple is bad.
	Thermocouple is not hot enough.
	Obstructed or wrong size pilot orifice.
	Gas supply is not purged of air.
	Air is blowing pilot light out.
Fat appears to smoke excessively.	Automatic pilot valve is bad.
	Heat is set too high.
Food sticks to grates.	Moisture in the food may be turning into steam.
	Heat is set too high.
	Griddle surface needs cleaning and/or seasoning.
Food is undercooked inside.	Surface under food may not have been covered with enough cooking oil.
	Heat is set too high.
Food tastes greasy or has objectionable off-flavor.	Food may not have been cooked for long enough time.
	Food itself may have off flavor.
	Food may have been stored improperly before cooking.
	Too much griddle fat used.

PARTS LIST:

GCB-18i & GCRB-18i

Item	P/N	Description	Quan	Item	P/N	Description	Quan
1	218207-55	Weldment, 18" Bullnose	1	35	218212-16	Radiant Med Duty - H	2
2	218215-11	Body, 18" Firebox GGM	1	36	43813149	Label, Warning Hot Surface (French)	1
3	8431300	1/4-20 Flanged Hex Locknut	6	37	8706300	Knob, Metal Cook line .375 D Shaft	1
4	21813085	Spacer	4	38	8633700	Leg, HD 2" Diameter W/Foot Flange.	4
5	22011191	Baffle, 18" Front Heat	1	39	2425400	Pan, Grease Cook Line 18" Short Draw	1
6	8417100	Nut, Hex, KEPS 10-32	6	40	21813029	Grate Support	1
7	22030005	Support, Leg 18", i-Line	2	41	3103800	Grill Grate	3
8	218215-13	Bracket, Manifold GCRB/GCB/GGM-18	1	42	2067300	Regulator, Convertible 3/4 1/2 PSIG	1
9	8153100	#8-32 X 3/8 Type T	11	43	8861000	Label, Spec	1
10	22011198	Manifold, 18" GCBi/GCRBi/GGMi	1	44	8809920	Decal, Improper Installation	1
11	2068200	Valve, Gas, On-Off	1	45	8832600	Label, Service Hotline	1
12	2066828	Orifice #28	1	46	8837130	Decal, Operating Instruction	1
13	2066841	Hood, Orifice #41	1	47	8825300	Decal, Leg	1
14	2092517	Plug, 1/8 NPTM	1	48	8822325	Decal, UL Sanitation, NSF Std. 4	1
15	2065643	Valve, 90° Pilot 1/8" NPT X 3/16	1	49	8837112	Label, Orifice Size	1
16	218207-28	Tube, Pilot	1	50	8837190	Tag, Orifice Location	1
17	218207-29	Bracket, Pilot GCRB/GCB/GGM-18	1	51	43813103	Label, Warning, Hot Surface	1
18	2066154	Pilot, Top	1	52*	2300100	Bags, Poly 36 x 27 x 44	1
19	218207-16	Side, Grease Chute	2	53*	2065847	Logo, APWWYOTT Casted	1
20	22011254	Side Panel, LH & RH, i-Line	2	54*	2901251	Carton, RSC 28.25 X 20.62 X 17, 275lbs	1
21	8170700	Screw, 10-32x1/2, Type AB	12	55*	29012-35	Pad Accessory	1
22	30047501	Guide, Grease Slide	2	56*	2901255	Post Corner	4
23	218207-57	Panel, Back	1	57*	8837201	Bag, Cloth, 4" x 6" w/Drawstring	1
24	218207-17	Support, Burner	2	58*	8838700	Manual, GCB-H/GCRB-H Champion II	1
25	81546-00	#8 X 3/8	4	59*	2900851	Skid, 21.75 X 29.5	1
26	218130-75	Burner "S"?	1	60*	2901240	Pad	1
27	31007-12	U-Nut C7685 10A Tinnerman	4	61*	8837400	Box Label, APW/Wyott	1
28	22011195	Baffle, Front Panel 18", i-Line	1	62*	3100001	Lava Rocks, 8lb Bag	1
29	22011196	Panel, Control 18" GCRBi/GCBi Safety /IGN	1	63*	2901231	Carton, RSC 23-7/16 X 16-1/16 X 4 275DW	2
	22011193	Panel, Control 18" GCRBi/GCBi/GGMi		64*	2300000	29 x 19 x 44 Poly	
30	81973-00	T/S #10 X 1/2 TPB Tr Hd	4	65*	8899300	List Of Service Agencies	1
33	218207-53	Support, 18" Rock Grate, Rear	1	66	3102205	Grate, Rock	1
34	218207-22	Support, 18" Rock Grate, Front	1	67	218207-26	Guard, Burner	3
						* = Not Shown	1

EXPLODED VIEW:

GCB-18i & GCRB-18i

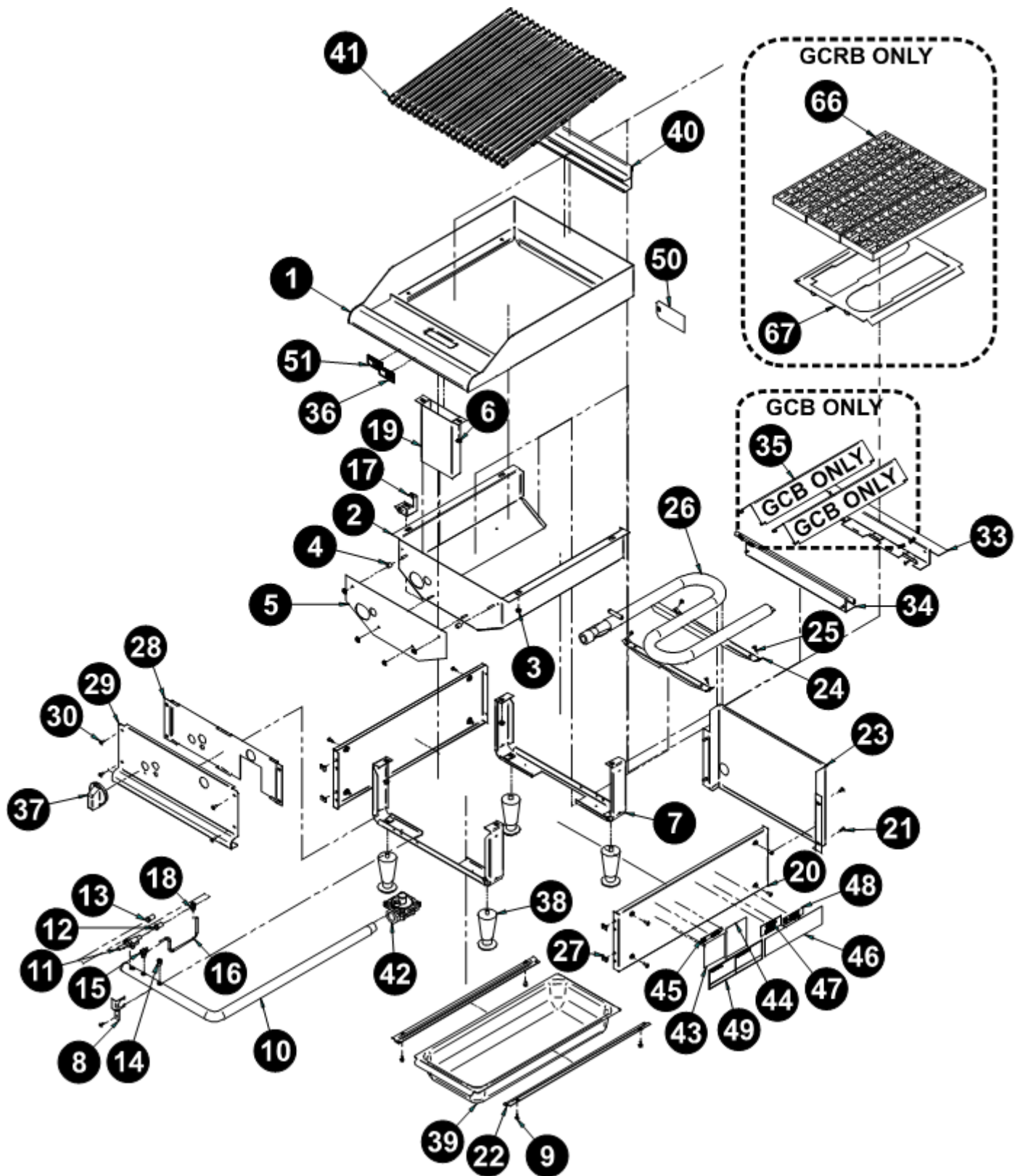

PARTS LIST:

GCB-24i & GCRB-24i

Item	P/N	Description	Quan	Item	P/N	Description	Quan
1	218208-55	Weldment, 24" Bullnose	1	36	21813129	Grate Support	1
2	218208-51	Body, 24" Firebox GCRB-GGM	1	37	8706300	Knob, Metal Cook Line .375 D Shaft	2
3	8417100	Nut, Hex, KEPS 10-32	6	38	2425500	Pan, Grease 24" Shallow Draw	1
4	8153100	#8-32 X 3/8 Type T	14	40*	8834910	Decal, Dial Plate Manual Gas Valve	1
5	81546-00	#8 X 3/8	6	41	2067300	Regulator, Convertible 3/4 1/2 PSIG	1
6	22030010	Support, Leg 24" i-Line	2	42	8825300	Decal, Leg	1
7	2068200	Valve, Gas, On-Off	2	43	43813149	Label, Warning Hot Surface (French)	1
8	21813085	Spacer	4	44	43813103	Label, Warning, Hot Surface	1
9	2066833	Hood, Orifice #33	2	45	8861000	Label, Spec	1
10	2092517	Plug, 1/8 NPTM	1	46	8832600	Label, Service Hotline	1
11	218208-17	Support, Burner	2	47	8837103	Label, Orifice Size	1
12	21820815	Manifold, 24" GCRB	1	48	8822325	Decal, UL Sanitation, NSF Std. 4	1
13	218208-18	Baffle, 24" Front Heat	1	49	8837130	Decal, Operator Instruction	1
14	22011198	Manifold, 18" GCBi/GCRBi/GGMi	2	50	8809920	Decal, Improper Installation	1
15	2068001	Pilot Valve	1	51	2066849	Hood, Orifice #49	2
16	8163100	M/S Pan Hd PH 10-32 X 1/4"	2	52	2092903	Pilot Natural@ 6" W.C.	1
17	22011254	Side Panel, LH & RH, i-Line	2	53*	2901255	Post Corner	4
18	30047501	Guide, Grease Slide	2	54*	2901252	Carton, HSC 28-1/4 X 26-5/8 X 17 275 Lbs	1
19	218208-25	Bracket, Pilot	1	55*	2901229	Pad, 21-13/16 X 23-3/16 200 Lbs	1
20	218212-16	Radiant Medium Duty - H	4	56*	29012-28	Cap, FTD 24.25 X 23.25 X 4 275 Lbs	1
21	2092800	Pilot, Broiler	1	57*	29012-27	Cap, FTD 23.43 X 22.06 X 4 275 Lbs	1
22	22011255	Baffle, Front Panel 24"	1	58*	29008-52	Skid, 27.75 X 29.5	1
23	218207-16	Side, Grease Chute	2	59*	2300000	29 x 19 x 44 Poly	1
24	31007-12	U-Nut C7685 10A Tinnerman	4	60*	3100001	Lava Rocks, 8 Lb Bag	1
25	8170700	Screw, 10-32 x 1/2, Type AB	12	61*	2901241	Pad, 26-1/4 X 27 200 Lbs	1
26	8431300	1/4-20 Flanged Hex Locknut	6	62*	8899300	List Of Service Agencies	1
27	21820727	Tube, Pilot Supply	1	63*	8837201	Bag, Cloth, 4" x 6" w/Drawstring	1
28	21813115	Panel, Back	1	64*	2300100	Bags, Poly 36 x 27 x 44	1
29	218208-52	Support, 24" Rock Grate Rear	1	65*	2065847	Decal, Front Panel GCB/GCRB/GGM-24	1
30	22011256	Panel, Control 24" GCRBi/GCBi Safety/IGN	1	66*	8837400	Box Label, APW/Wyott	1
	22011253	Panel, Control 24" GCRBi/GCBi/GGMi	1	67*	8838700	Logo, APWWYOTT Casted	1
31	218208-22	Support, 24" Rock Grate Front	1	68*	218133-39	Pilot Shield	1
32	81973-00	T/S #10 X 1/2 TPB Tr Hd	4	69	3102205	Grate, Rock	4
33	3103800	Grill Grate	4	70	218207-25	Guard, Burner	2
34	8837190	Tag, Orifice Location	1			* = NOT SHOWN	
35	8632000	Leg, HD 2" Diameter W/Foot Flange	4				

EXPLODED VIEW:

GCB-24i & GCRB-24i

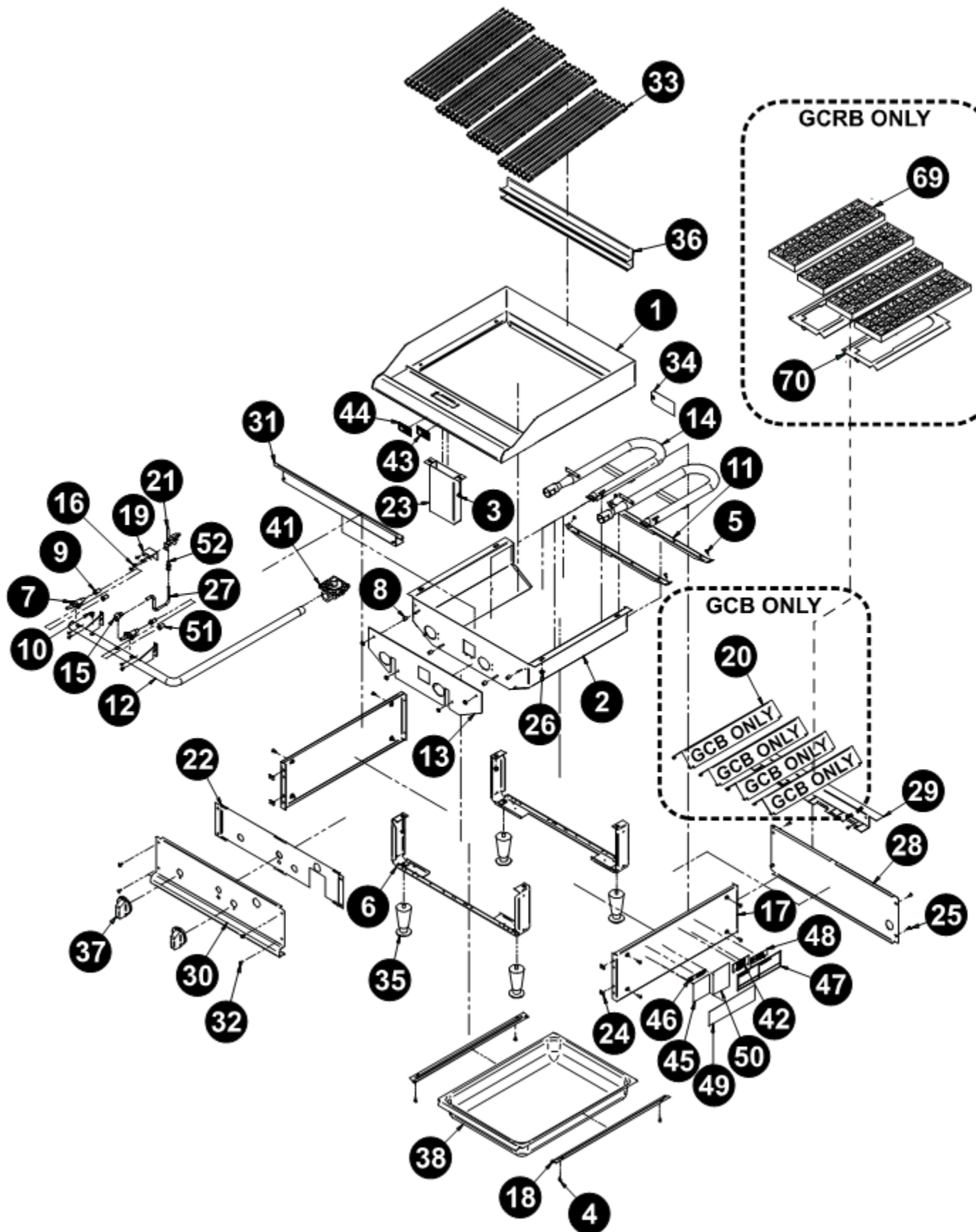

PARTS LIST:

GCB-36i & GCRB-36i

Item	P/N	Description	Quan	Item	P/N	Description	Quan
1	218209-55	Weldment, Bullnose 36"	1	37	218209-22	Support, 36" Rock Grate Front	1
2	218209-51	Body, 36" Firebox GGM	1	38	43813149	Label, Warning Hot Surface (French)	1
3	218209-52	Support, 36" Firebox Divider	1	39	218212-16	Radiant Med Duty - H	6
4	81546-00	#8 X 3/8	12	40	8633700	Leg, HD 2" Diameter W/Foot Flange.	4
5	218209-56	Divider, Firebox	1	41	2425400	Pan, Grease Cook Line 18" Short Draw	2
6	8431300	1/4-20 Flanged Hex Locknut	6	42	8706300	Knob, Metal Cook Line .375 D Shaft	3
7	21813085	Spacer	5	43	21813229	Weldment, Grate Support	1
8	218209-18	Baffle, 36" Front Heat	1	44	3103800	Grill Grate	6
9	8417100	Nut, Hex, KEPS 10-32	7	45	2067300	Regulator, Convertible 3/4 1/2 Psig	1
10	218207-16	Side, Grease Chute	2	46	8861000	Label, Spec	1
11	218209-15	Manifold, 36" GCRB	1	47	8809920	Decal, Improper Installation	1
12	8153100	#8-32 X 3/8 Type T	20	48	8832600	Label, Service Hotline	1
13	2068200	Valve, Gas, On-Off	3	49	8837103	Label, Orifice Size	1
14	2066833	Hood, Orifice #33	3	50	8825300	Decal, Leg	1
15	2066849	Hood, Orifice #49	3	51	8822325	Decal, UL Sanitation, NSF Std. 4	1
16	2092517	Plug, 1/8 NPTM	1	52	8837130	Decal, Operating Instruction	1
17	218208-25	Bracket, Pilot	2	53	2065847	Logo, APWWYOTT Casted	1
18	2092800	Pilot, Broiler	2	54	8837190	Tag, Orifice Location	1
19	8163100	M/S Pan Hd Ph 10-32 X 1/4"	4	55	43813103	Label, Warning, Hot Surface	1
20	2092903	Pilot Natural@ 6" W.C.	2	56*	8837400	Box Label, APW/Wyott	1
21	2068001	Pilot Valve	2	57*	8838700	Manual, GCB-H/GCRB-H Champion II	1
22	21820727	Tube, Pilot Supply	2	58*	8837201	Bag, Cloth, 4" x 6" w/Drawstring	1
23	218209-17	Support, Burner	2	59*	8899300	List of Service Agencies	1
24	22011198	Manifold, 18" GCBi/GCRBi/GGMi	3	60*	2300000	29 x 19 x 44 Poly	1
25	22030015	Support, Leg 36", i-Line	2	61*	2300100	Bags, Poly 36 x 27 x 44	1
26	22011254	Side Panel, LH & RH, i-Line	2	62*	29008-53	Skid, 40.5 X 29.5	1
27	8170700	Screw, 10-32 x 1/2, Type AB	12	63*	2901255	Post Corner	4
28	30047501	Guide, Grease Slide	4	64*	2901231	Carton, RSC 23-7/16 X 16-1/16 X 4 275DW	2
29	218209-57	Panel, Back	1	65*	29012-35	Pad Accessory	2
30	31007-12	U-Nut C7685 10A Tinnerman	4	66*	29012-42	Pad	1
31	22011375	Baffle, Front Panel 36", i-Line	1	67*	2901253	Carton, HSC 39.25 X 28.62 X 17 275lbs	1
32	22011376	Panel, Control 36" GCRBi/GCBi SAFTEY/IGN	1	68	3102205	Grate, Rock	6
	22011373	Panel, Control 36" GCRBi/GCBi/GGMi		69	218207-25	Guard, Burner	3
33	81973-00	T/S #10 X 1/2 TPB Tr Hd	4	70*	218133-39	Pilot Shield	2
36	218209-53	Support, 36" Rock Grate Rear	1			* = NOT SHOWN	

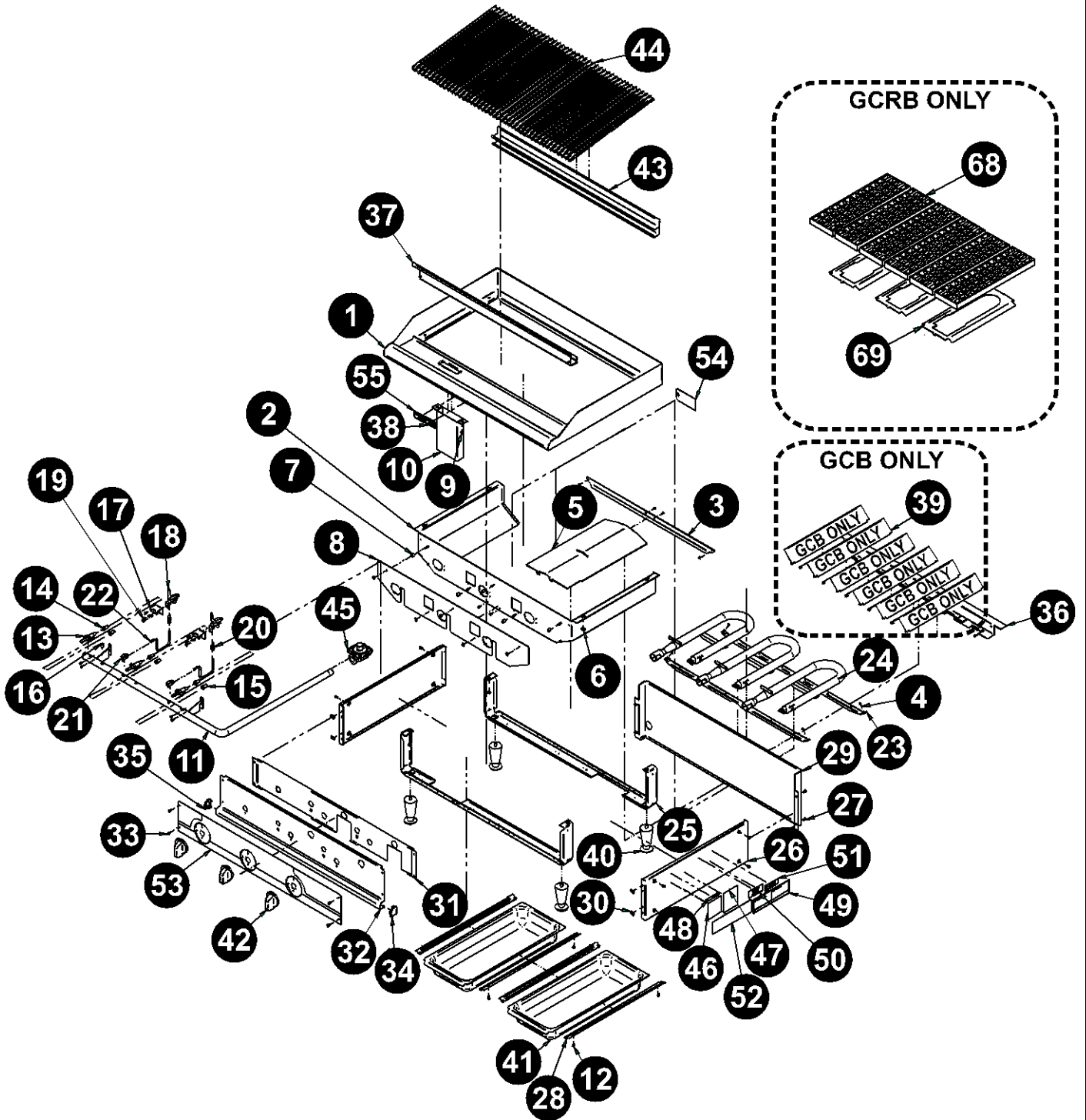

PARTS LIST:

GCB-48i & GCRB-48i

Item	P/N	Description	Quan	Item	P/N	Description	Quan
1	218210-55	Weldment, 48" Bullnose	1	36	218210-22	Support, 48" Rock Grate Front	1
2	8417100	Nut, Hex, KEPS 10-32	7	37	22030020	Support, Leg 48", i-Line	2
3	8153100	#8-32 X 3/8 Type T	20	38*	2065847	Logo, APWWYOTT Casted.	1
4	81546-00	#8 X 3/8	12	40	2066849	Hood, Orifice #49	4
5	218208-25	Bracket, Pilot	2	41	3103800	Grill Grate	8
6	2092800	Pilot, Broiler	2	42*	8837400	Box Label, APW/Wyott	2
7	8633700	Leg, HD 2" Diameter W/Foot Flange	4	43	218207-16	Side, Grease Chute	2
8	218209-56	Divider, Firebox	1	44	43813103	Label, Warning, Hot Surface	1
9	8163100 M/S	Pan Hd Ph 10-32 X 1/4"	4	45	2067300	Regulator, Convertible 3/4 1/2 PSIG	1
10	2066833	Hood, Orifice #33	4	46	2092903	Pilot Nat @ 6" W.C.	2
11	2068200	Valve, Gas, On-Off	4	47	8832600	Label, Service Hotline	1
12	21813085	Spacer	5	48	8809920	Decal, Improper Installation	1
13	2092517	Plug, 1/8 NPTM	1	49	8861000	Label, Spec	1
14	218210-17	Support, Burner	2	50	8837103	Label, Orifice Size	1
15	21821015	Manifold, 48" GCRB/GCB/GGM	1	51	43813149	Label, Warning Hot Surface (French)	1
16	218210-18	Baffle, 48" Front Heat	1	52	8837130	Decal, Operator Instruction	1
17	2068001	Pilot Valve	2	53	8825300	Decal, Leg	1
18	22011198	Manifold, 18" GCBi/GCRBi/GGMi	4	54	8822325	Decal, UL Sanitation, NSF Std. 4	1
19	22011254	Side Panel, LH & RH, i-Line	2	55*	29012-27	Cap, FTD 23.43 X 22.06 X 4 275 Lbs	2
20	30047501	Guide, Grease Slide	4	56*	29012-28	Cap, FTD 24.25 X 23.25 X 4 275 Lbs	2
21	218212-16	Radiant Med Duty - H	8	57*	29012-43	Pad, 27 X 52.5 200lbs	1
22	218210-51	Body, 48" Firebox GGM	1	58*	2901229	Pad, 21-13/16 X 23-3/16 200lbs	2
23	81973-00	T/S #10 X 1/2 TPB Tr Hd	4	59*	2901254	Carton, HSC 2pcs 51.25 X 25.62 X 17 275lbs	2
24	8706300	Knob, Metal Cook Line .375 D Shaft	4	60*	2901255	Post Corner	6
25	22011495	Baffle, Front Panel 48" i-Line	1	61*	29008-54	Skid, 52.5 X 29.5	1
26	31007-12	U-Nut C7685 10A Tinnerman	4	62*	2300000	29 x 19 x 44 Poly	2
27	8170700	Screw, 10-32x1/2, Type AB	12	63*	8899300	List Of Service Agencies	1
28	2425500	Pan, Grease 24" Shallow Draw	2	64*	8837201	Bag, Cloth, 4" x 6" w/Drawstring	1
29	8431300	1/4-20 Flanged Hex Locknut	6	65*	8838700	Manual, GCB-H/GCRB-H Champion II	1
30	21820727	Tube, Pilot Supply	2	66	8837190	Tag, Orifice Location	1
31	218210-57	Panel, Back	1	67	218210-52	Support, 48" Firebox Divider	1
32*	8834900	Decal, Dial Plate Manual Gas Valve	1	68	3102205	Grate, Rock	8
33	218210-53	Support, 48" Rock Grate Rear	1	69	218207-25	Guard, Burner	4
34	21813329	Weldment, Grate Support	1	70*	3100001	Lava Rocks, 8 lb Bag	2
35	22011496	Panel, Control 48" GCRBi/GCBi/GGM SAF/IG	1			* = NOT SHOWN	
	22011493	Panel, Control 48" GCRBi/GCBi/GGMi	1				

APW WYOTT EQUIPMENT LIMITED WARRANTY

APW Wyott Foodservice Equipment Company warrants its equipment against defects in materials and workmanship, subject to the following conditions:

This warranty applies to the original owner only and is not assignable.

Should any product fail to function in its intended manner under normal use within the limits defined in this warranty, at the option of APW Wyott such product will be repaired or replaced by APW Wyott or its Authorized Service Agency. APW Wyott will only be responsible for charges incurred or service performed by its Authorized Service Agencies. The use of other than APW Wyott Authorized Service Agencies will void this warranty and APW Wyott will not be responsible for such work or any charges associated with same. The closest APW Wyott Authorized Service Agent must be used.

This warranty covers products shipped into the 48 contiguous United States, Hawaii, metropolitan areas of Alaska and Canada. There will be no labor coverage for equipment located on any island not connected by roadway to the mainland.

Warranty coverage on products used outside the 48 contiguous United States, Hawaii, and metropolitan areas of Alaska and Canada may vary. Contact the international APW Wyott distributor, dealer, or service agency for details.

Time Period

One year for parts and one year for labor, effective from the date of purchase by the original owner. The Authorized Service Agency may, at their option, require proof of purchase. Parts replaced under this warranty are warranted for the un-expired portion of the original product warranty only.

Exceptions

- * **Gas/Electric Cookline:** Models GCB, GCRB, GF, GGM, GGT, CHP-H, EF, EG, EHP. Three (3) Year Warranty on all component parts, except switches and thermostats. (2 additional years on parts only. No labor on second or third year.)
- * **Broiler Briquettes, Rock Grates, Cooking Grates, Burner Shields, Fireboxes:** 90 Day Material Only. No Labor.
- * **Heat Strips:** Models FD, FDL, FDD, FDDL. Two (2) Year Warranty on element only. No labor second year.
- * **Glass Windows, Doors, Seals, Rubber Seals, Light Bulbs:** 90 Day Material Only. No Labor.

In all cases, parts covered by extended warranty will be shipped FOB the factory after the first year.

Portable Carry In Products

Equipment weighing over 70 pounds or permanently installed will be serviced on-site as per the terms of this warranty. Equipment weighing 70 pounds or under, and which is not permanently installed, i.e. with cord and plug, is considered portable and is subject to the following warranty handling limitations. If portable equipment fails to operate in its intended manner on the first day of connection, or use, at APW Wyott's option or its Authorized Service Agency, it will be serviced on site or replaced.

From day two through the conclusion of this warranty period, portable units must be taken to or sent prepaid to the APW Wyott Authorized Service Agency for in-warranty repairs. No mileage or travel charges are allowed on portable units after the first day of use. If the customer wants on-site service, they may receive same by paying the travel and mileage charges. Exceptions to this rule: (1) countertop warmers and cookers, which are covered under the Enhanced Warranty Program, and (2) toasters or rollergrills which have in store service.

Exclusions

The following conditions are not covered by warranty:

- * Equipment failure relating to improper installation, improper utility connection or supply and problems due to ventilation.
- * Equipment that has not been properly maintained, calibration of controls, adjustments, damage from improper cleaning and water damage to controls.
- * Equipment that has not been used in an appropriate manner, or has been subject to misuse or misapplication, neglect, abuse, accident, alteration, negligence, damage during transit, delivery or installation, fire, flood, riot or act of god.
- * Equipment that has the model number or serial number removed or altered.

If the equipment has been changed, altered, modified or repaired by other than an Authorized Service Agency during or after the warranty period, then the manufacturer shall not be liable for any damages to any person or to any property, which may result from the use of the equipment thereafter.

This warranty does not cover services performed at overtime or premium labor rates. Should service be required at times which normally involve overtime or premium labor rates, the owner shall be charged for the difference between normal service rates and such premium rates. APW Wyott does not assume any liability for extended delays in replacing or repairing any items beyond its control.

In all cases, the use of other than APW Wyott Authorized OEM Replacement Parts will void this warranty.

This equipment is intended for commercial use only. Warranty is void if equipment is installed in other than commercial application.

Water Quality Requirements

Water supply intended for a unit that has in excess of 3.0 grains of hardness per gallon (GPG) must be treated or softened before being used. Water containing over 3.0 GPG will decrease the efficiency and reduce the operation life of the unit.

Note: Product failure caused by liming or sediment buildup is not covered under warranty.

"THE FOREGOING WARRANTY IS IN LIEU OF ANY AND ALL OTHER WARRANTIES EXPRESSED OR IMPLIED INCLUDING ANY IMPLIED WARRANTY OF MERCHANTABILITY OR FITNESS FOR PARTICULAR PURPOSES AND CONSTITUTES THE ENTIRE LIABILITY OF APW WYOTT. IN NO EVENT DOES THE LIMITED WARRANTY EXTEND BEYOND THE TERMS STATED HEREIN."

9/05