

NOTE:
1. DOOR IS OPENED.
2. WIRE COLOR

SYMBOL	COLOR
BK	BLACK
BN	BROWN
BL	BLUE
GN	GREEN
PK	PINK
RD	RED
WH	WHITE
YL	YELLOW

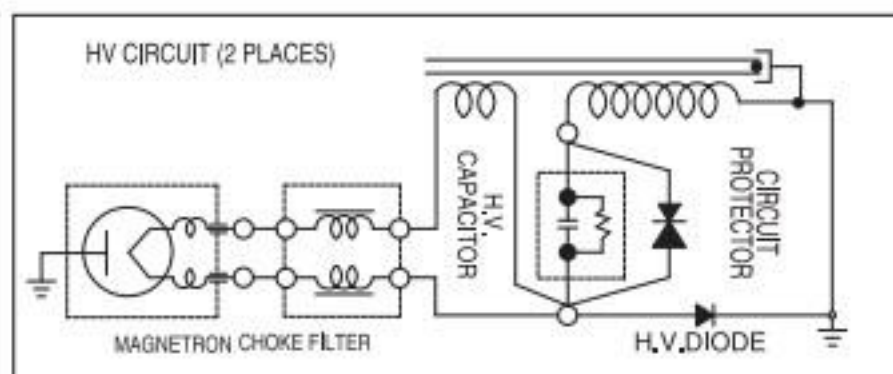

NOISE FILTER ASSEMBLY

FUSE HOLDER

AC 120V/60Hz
SINGLE PHASE ONLY

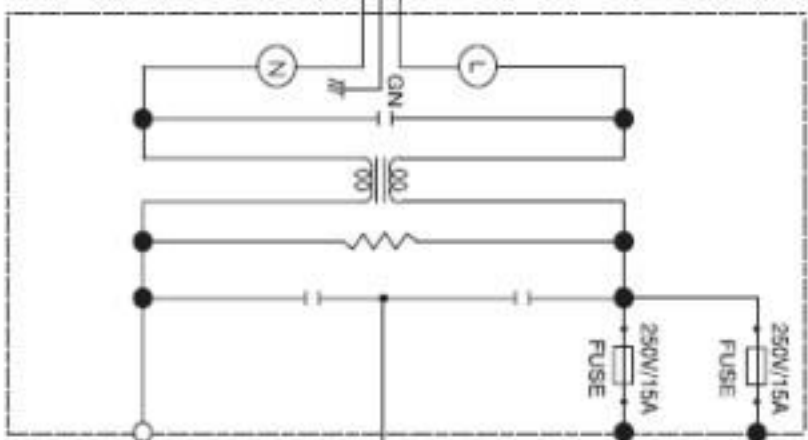

BTM MGT
TOO

BTM PRIMARY
INTERLOCK
SWITCH



TOP MGT
TOO

TOP PRIMARY
INTERLOCK
SWITCH

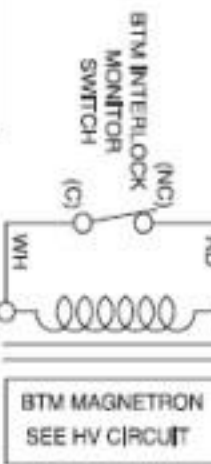

BLM
BLOWER MOTOR

BTM STIRRER
MOTOR

OL
OVEN LIGHT

SM
TOP STIRRER
MOTOR

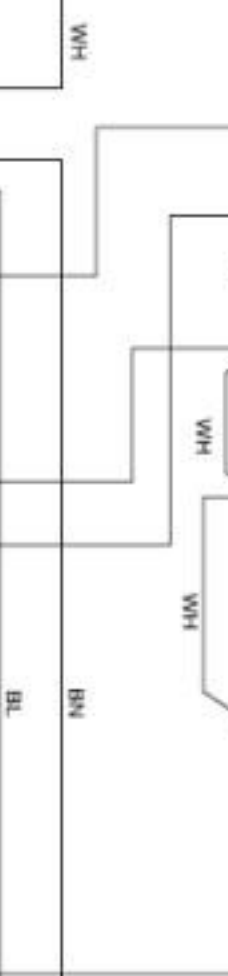

BL

BN

SECONDARY
INTERLOCK
SWITCH

NOTE
1. DOOR IS OPENED.
2. WIRE COLOR

SYMBOL	COLOR
BK	BLACK
BN	BROWN
BL	BLUE
GN	GREEN
PK	PINK
RD	RED
WH	WHITE
YL	YELLOW

MAIN PCB



L.V. TRANSFORMER

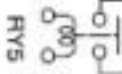
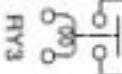
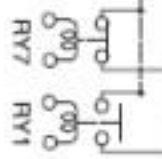
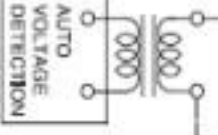

(CN1)

BL

BN

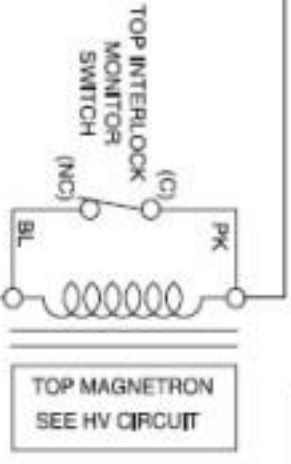

TOP MAGNETRON
SEE HV CIRCUIT

BTM MAGNETRON
SEE HV CIRCUIT

