

Repair Parts List

MODEL NUMBER

RFS10SW2

MANUFACTURING
NUMBER

P1324702M

COMMERCIAL MICROWAVE

When requesting service or ordering parts, always provide the following information:

- Product Type
- Part Number
- Model Number
- Part Description

Amana[®]
HIGH PERFORMANCE HAS A NAME™

PART OF  FOODSERVICE GROUP

December 15 2006

Section: Outer Cabinet

Model: RFS10SW2_P1324702M

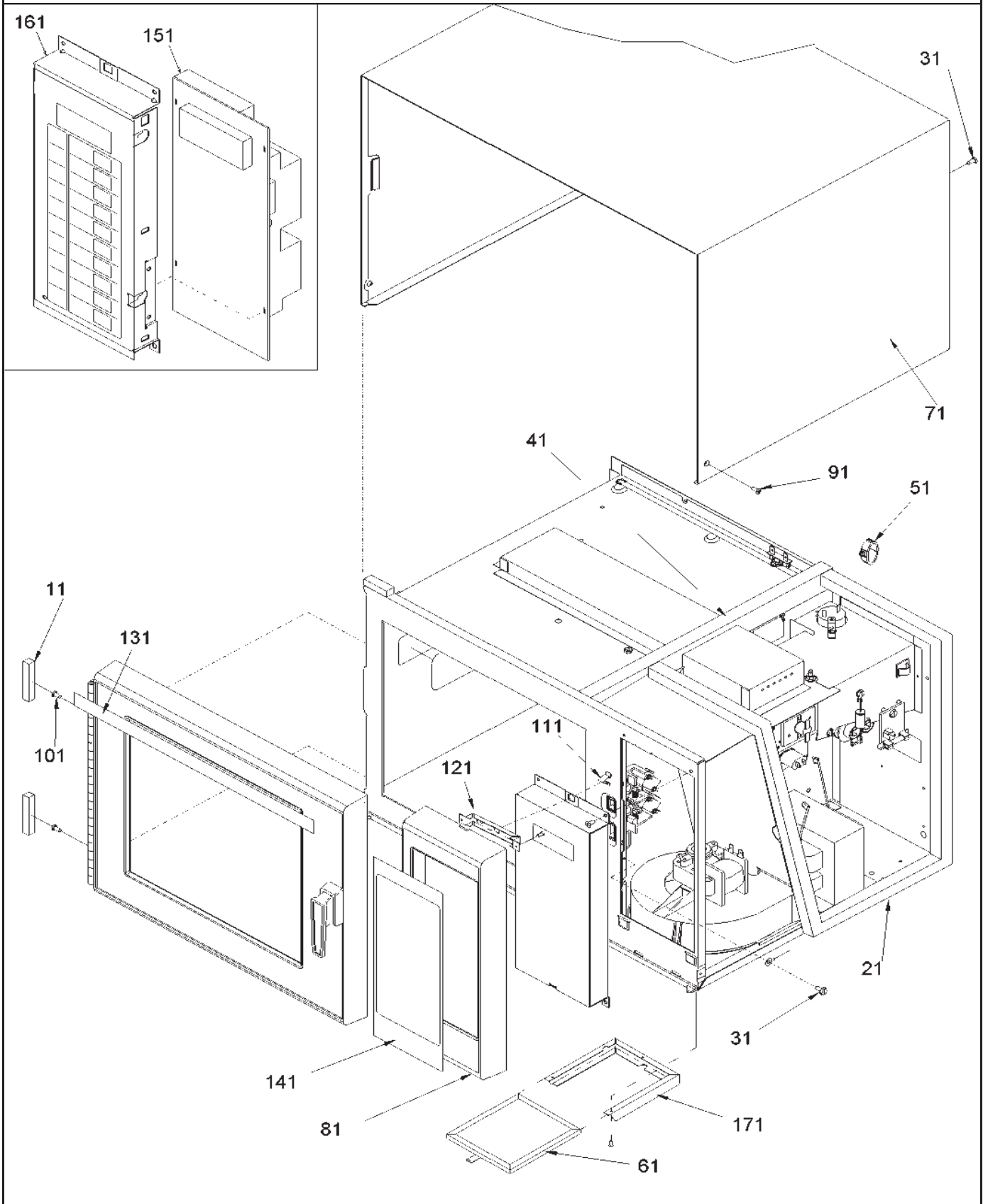

Section: Outer Cabinet

No.	Part No.	Description	Series Qty
11	A3263904	GASKET	2
21	A3263907	GASKET - EACH	1
31	M0213147	SCREW	4
31	M0231717	SCREW, TF	13
41	B8369901	GASKET, OVEN TOP	1
51	M0118705	CLIP, GUIDE	1
61	10169101Q	FILTER PREFORM	1
71	D7684903	WRAPPER	1
81	D7730101	ESCUTCHEON CONTROL	1
91	M0249632	SCREW, T F	2
101	M0216716	SCREW	4
111	B8379401	CLIP	1
121	C8960301	BRACKET	1
131	C8962460	THINPLATE, DOOR	1
141 N	10055104	INSERT, ESCUTCHEON	1
151	12495205Q	KIT,HV/LV BOARD	1
161	R9900591	ASSY, TOUCH PANEL	1
171	D7740902	BRACKET	1

Section: Internal Components

Model: RFS10SW2_P1324702M

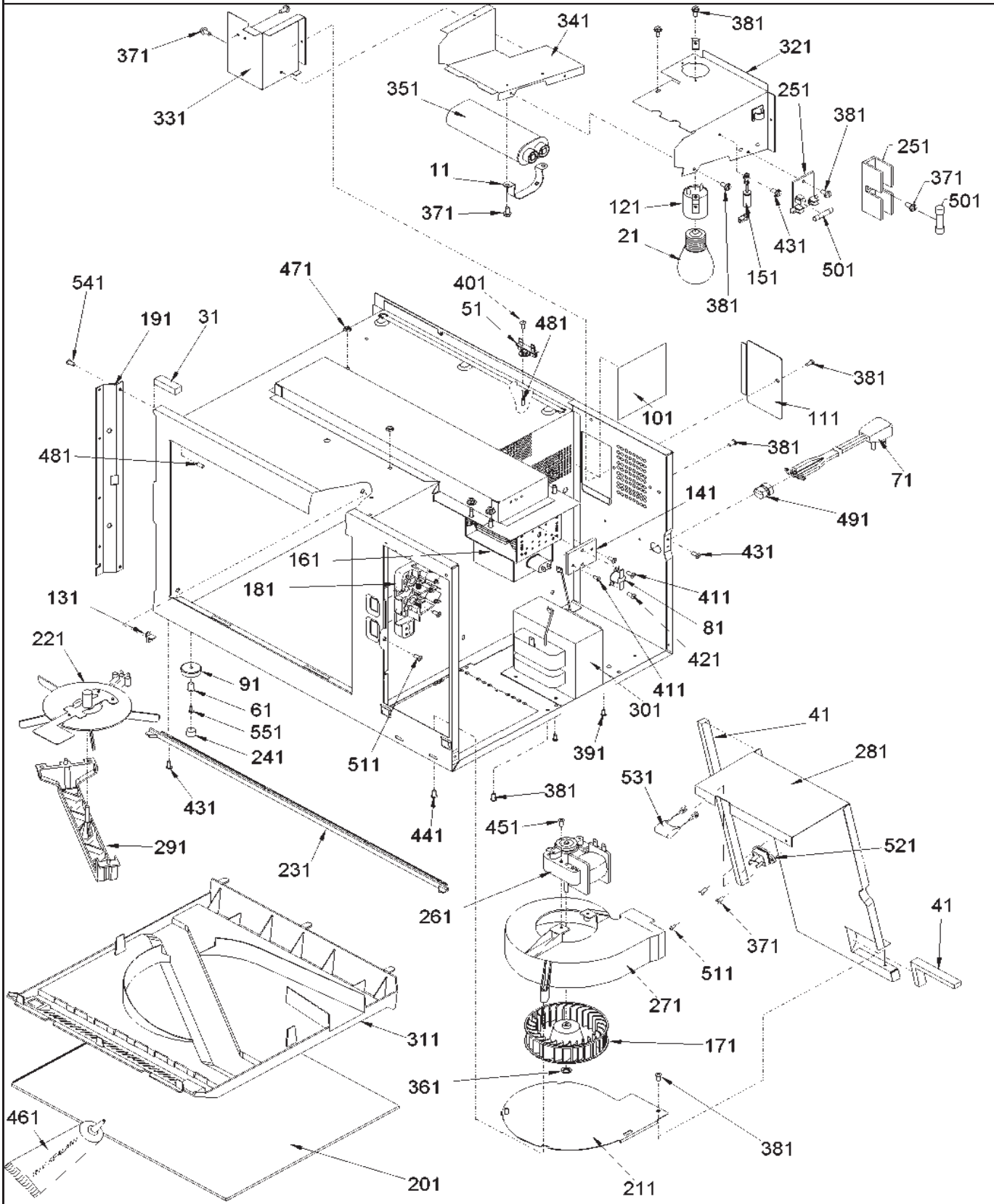

Section: Internal Components

No.	Part No.	Description	Series Qty
11	A4055406	STRAP, CAPACITOR	1
21	10664502	LAMP 41W	1
31	A3030301	GASKET (INCH)	2
41	A3030302	GASKET	19
51	B5795305	FUSE, THERMAL	1
61	M0571201	EYELET	4
71	10098918	POWER CORD	1
81	B5684106	THERMAL PROTECTOR	1
91	C8960601	FOOT, OUTER CASE	4
101	B8367701	WINDOW, OVEN LIGHT	1
111	B8370701	COVER, LIGHT	1
121	B8371401	RECEPTACLE, LAMP	1
131	B8374901	SUPPORT, SHELF	2
151	B8383101	RECTIFIER	1
161	10489401	MAGNETRON	1
171	C8793501	BLOWER WHEEL	1
181	12360506	SWITCH, INTERLOCK	1
191	C8935903	BRKT,HINGE SUPPORT	1
201	C8936902	TRAY-GLASS FLOOR	1
211	C8942501	BRKT SCROLL	1
221	C8943002Q	ASSY, ANTENNA	1
231	C8943602	TRIM	1
241	C8965404	PLUG BUTTON	4
251	10091101	FUSE HOLDER	1
261	D7670306	MOTOR, BLOWER	1
271	D7684601	SCROLL, BLOWER	1
281	D7685413	BLOWER PARTITION,BLACK E CT	1
291	D7685505	CRADLE, ANTENNA	1
301	10426611	TRANSFORMER	1
311	D7692501	GREASE SHIELD	1
321	D7772007	DUCT, TOP AIR	1
331	D7772101	SHIELD, LIGHT	1
341	D7772202	AIR DUCT. BOTTOM	1
351	10366919	CAPACITOR	1
361	M0118903	CLIP-BLWR RET	1
371	M0216515	SCREW	8
381	M0216703	SCREW ***	9
391	M0216729	SCREW	2
401	M0234029	SCREW	1
411	M0229916	SCREW T.C	2
431	M0231604	SCREW, TF	4
441	M0230017	SCREW,TC	5
451 N	M0213123	SCREW	2
461	M0275598	SEALER	1
471 N	M0288808	NUT	2
481	M0308801	CAP, PROTECTIVE-THREADED (RED)	2
491	M0370003	STRAIN RELIEF	1
501	M0805205	FUSE- 30A	1
511	M0216517	SCREW	2
521	R0157373	KIT, TRIAC ASSY	1
531	10172901Q	SNUBBER ASSEMBLY	1
541	M0231717	SCREW, TF	2
551	M0213147	SCREW	4
9999	12512102	HARNESS, OVEN	1

12/06

*Color Code (-)=Not Shown #=Series, Serial Prefix or Run No., N=Not Available

Section: Door Assembly

Model: RFS10SW2_P1324702M

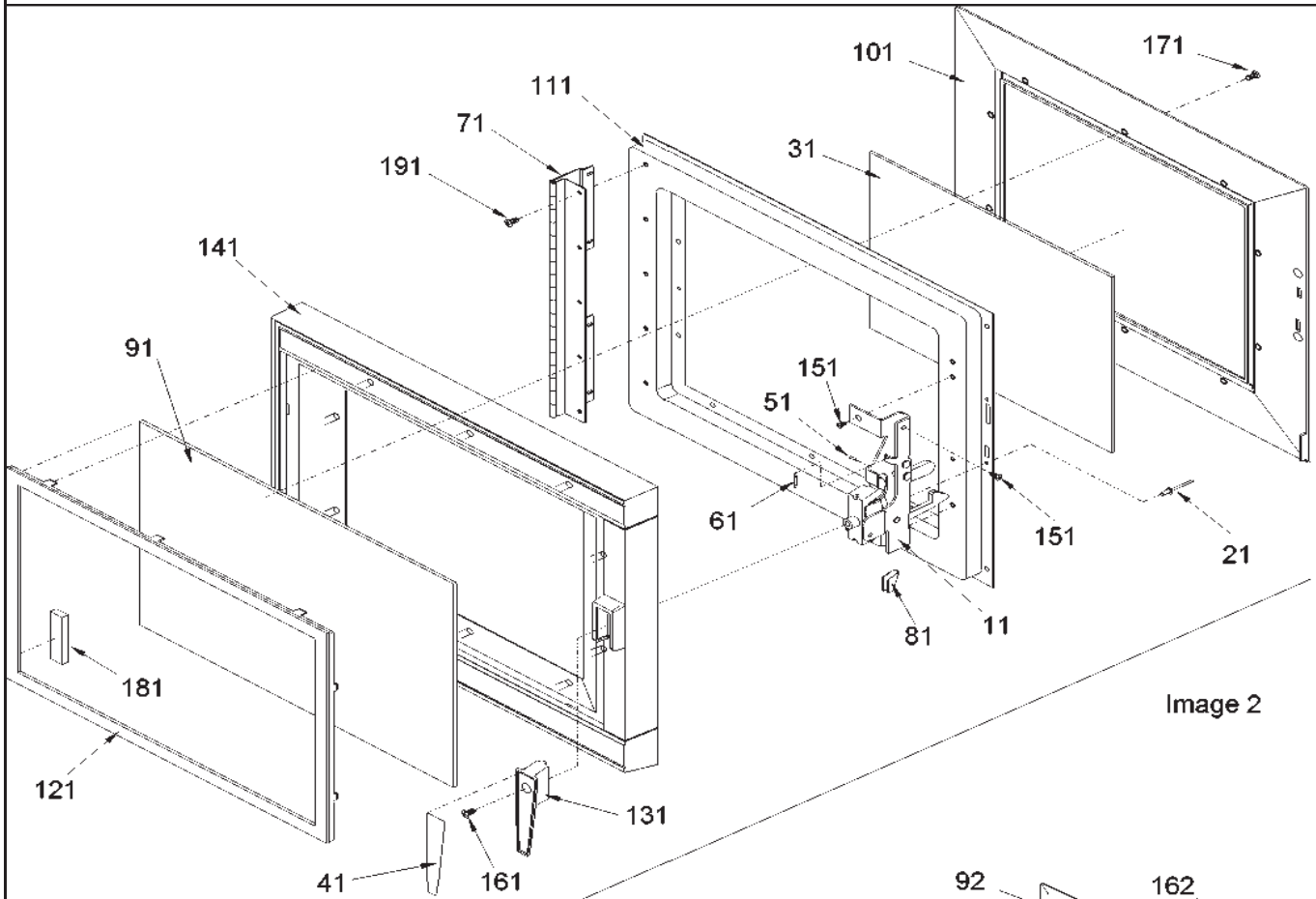

Image 2

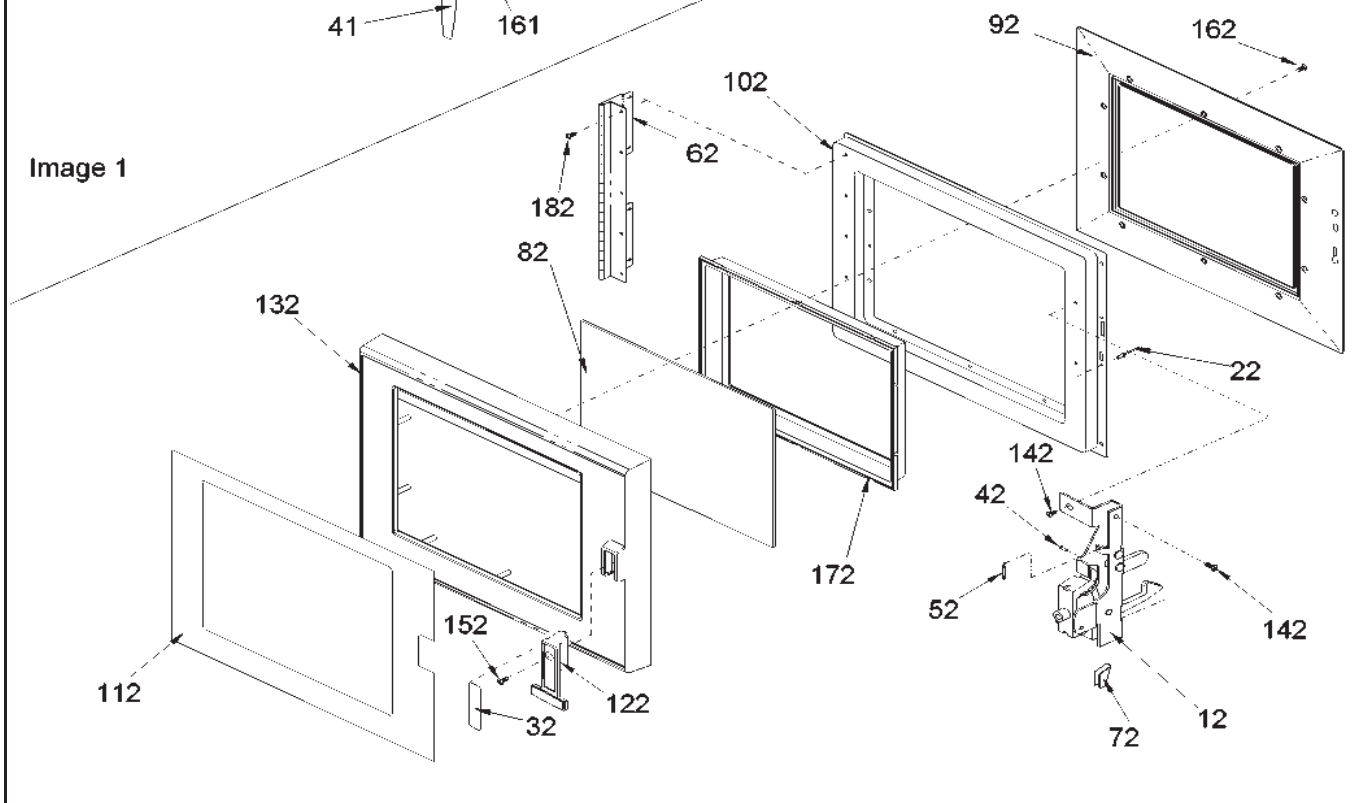

Image 1

Section: Door Assembly

No.	Part No.	Description	Series Qty
12	R0150122	LATCH ASSY Note: INCLUDES LATCH PIN, DOOR LATCH SPRING & LATCH HANDLE PAD.	1
22	A4539601	POP RIVET	2
32	B8381101	INSERT, HANDLE	1
42	B8379201	PIN, LATCH	1
52	C8893502	SPRING, DOOR LATCH	1
62	C8961811	HINGE-DOOR	1
72	C8991301	PAD-LATCH ASSY	1
82	C8960401	WINDOW, OUTER	1
92	D7784901	INNER DOOR/GLASS ASSY	1
102	D7683719	WELDMENT-INNER DOOR (BLK)	1
112	D7738601	INSERT DR	1
122	D7751101	HANDLE FRONT TEE	1
132	D7730001	DOOR, OUTER	1
142	M0216703	SCREW ***	4
152	M0234030	SCREW	1
162	M0232218	SCREW, HI/LO Y DRIVE	10
172	D7731103	RETAINER, LENS	1
182	M0216716	SCREW	5

Section: SUPPLEMENTAL INFORMATION

No.	Part No.	Description	Series	Qty
1	12392640	MNL,OWNERS(COMM'L MICRO)		1
1	RS2240001	SVC MNL, COMM'L MICRO		1
1	RP2240008	MNL,PTS-COMM MICRO OVEN		1
1	R0193574	MAGNETIC Y-DRIVE BIT		1
1	N M5D350	H.V. LEAD KIT		1
1	M0275598	SEALER		0