



# Service / Training Manual

High Speed Combination Oven



AXP / MXP - 60 Hz  
MXP22QT  
December 2011  
16400012

Amana® is a Registered Trademark of Maytag Corporation. Brand used under license.



# Table of Contents

Important Safety Information.....	1-5
Installation.....	7
Specifications.....	8
Quick Start Reference Guide AXP20 / MXP20.....	9-14
Touch Panel Symbol Description AXP22 / MXP22.....	15-16
Quick Start Reference Guide AXP22 / MXP22.....	17-23
Oven Construction AXP20 / MXP20, AXP22 / MXP22.....	24-31
AXP22 / MXP22 Ceramic Tray and Replaceable Waveguide.....	32
Interlock Switch Service.....	33-34
Oven Performance Test AXP20 / MXP20, AXP22 / MXP22.....	35-38
Component Testing Procedures AXP20 / MXP20, AXP22 / MXP22.....	39-41
Service Test AXP20 / MXP20.....	42-50
Troubleshooting AXP20 / MXP20.....	51-56
Display Diagnostics AXP20 / MXP20.....	57-58
Service Test AXP22 / MXP22.....	59-66
Troubleshooting AXP22 / MXP22.....	67-72
Display Diagnostics AXP22 / MXP22.....	73-74
Wiring Diagrams / Schematics Sample AXP20 / MXP20, AXP22* / MXP22* .....	75-79

# **1** | **Important Safety Information**

# Important Information

## Important Notices for Servicers and Consumers

ACP will not be responsible for personal injury or property damage from improper service procedures. Pride and workmanship go into every product to provide our customers with quality products. It is possible, however, that during its lifetime a product may require service. Products should be serviced only by a qualified service technician who is familiar with the safety procedures required in the repair and who is equipped with the proper tools, parts, testing instruments and the appropriate service information. IT IS THE TECHNICIANS RESPONSIBILITY TO REVIEW ALL APPROPRIATE SERVICE INFORMATION BEFORE BEGINNING REPAIRS.

 <b>WARNING</b>
To avoid risk of severe personal injury or death, disconnect power before working/servicing on appliance to avoid electrical shock.

To locate an authorized servicer please contact:

ComServ Support Center



Web Site  
WWW.ACPSOLUTIONS.COM

Telephone Number  
..... 1-866-426-2621 or 319-368-8195

E-Mail: [commercialservice@acpsolutions.com](mailto:commercialservice@acpsolutions.com)

Recognize Safety Symbols, Words, and Labels

 <b>DANGER</b>
---

DANGER— Immediate hazards which WILL result in severe personal injury or death.

 <b>WARNING</b>
--

WARNING— Hazards or unsafe practices which COULD result in severe personal injury or death.

 <b>CAUTION</b>
--

CAUTION— Hazards or unsafe practices which COULD result in minor personal injury, product or property damage.

# Important Safety Information



## WARNING

Read the following information to avoid possible exposure to microwave radiation:

The basic design of the Microwave Oven makes it an inherently safe device to both use and service.

However, there are some precautions which should be followed when servicing the microwave to maintain this safety. These are as follows:

1. Always operate the unit from an adequately grounded outlet. Do not operate on a two-wire extension cord.
2. Before servicing the unit (if unit is operable) perform the microwave leakage test.
3. The oven should never be operated if the door does not fit properly against the seal, the hinges or hinge bearings are damaged or broken; the choke is damaged, (pieces missing, etc.); or any other visible damage can be noted. Check the choke area to ensure that this area is clean and free of all foreign matter.
4. If the oven operates with the door open and produces microwave energy, take the following steps:
  - A. Tell the user not to operate the oven.
  - B. Contact ACP ComServ immediately.
5. Always have the oven disconnected when the outer case is removed except when making the "live" tests called for in the Service Manual. Do not reach into the equipment area while the unit is energized. Make all connections for the test and check them for tightness before plugging the cord into the outlet.
6. Always ground the capacitors on the magnetron filter box with an insulated-handle screwdriver before working in the high voltage area of the equipment compartment. Some types of failures will leave a charge in these capacitors and the discharge could cause a reflex action which could make you injure yourself.
7. Always remember that in the area of the transformer there is HIGH VOLTAGE. When the unit is operating keep this area clear and free of anything which could possibly cause an arc or ground, etc.
8. Do not for any reason defeat the interlock switches there is not valid reason for this action at any time; nor will it be condoned by ACP.
9. IMPORTANT: Before returning a unit to a customer, be sure to check for proper switch interlock action.
10. The Microwave Oven should never be operated with any components removed and/or bypassed or when any of the safety interlocks are found to be defective, or when any of the seal surfaces are defective, missing, or damaged.
11. All microwave ovens meet all requirements of the radiation control for Health and Safety Act of 1968. Due to measurement uncertainties, the maximum leakage for the field will be  $4\text{mw}/\text{cm}^2$ .
12. To ensure that the unit does not emit excessive microwave leakage and to meet the Department of Health and Human Services guidelines, check the oven for microwave leakage using a microwave oven leakage meter that complies with US Government CDRH / FDA / DHHS requirements and or any other local government requirements. The maximum leakage level allowed by ACP is  $4\text{mw}/\text{cm}^2$ .
13. If servicer encounters an emission reading over  $4\text{mw}/\text{cm}^2$ , the servicer is to cease repair and contact the ACP ComServ Department immediately for further direction. ACP will contact the proper Government Agency upon verification of the test results.

# IMPORTANT SAFETY INSTRUCTIONS



Recognize this symbol as a **SAFETY** message



## WARNING

When using electrical equipment, basic safety precautions should be followed to reduce the risk of burns, electrical shock, fire, or injury to persons including the following.

1. READ all instructions before using equipment.
2. READ AND FOLLOW the specific “PRECAUTIONS TO AVOID POSSIBLE EXPOSURE TO EXCESSIVE MICROWAVE ENERGY” on this page.
3. This equipment **MUST BE GROUNDED**. Connect only to properly GROUNDED outlet. See “GROUNDING / EARTHING INSTRUCTIONS” on page 5.
4. Install or locate this equipment **ONLY** in accordance with the installation instructions in this manual.
5. Some products such as whole eggs and sealed containers—for example, closed glass jars—are able to explode and **SHOULD NOT** be HEATED in this oven.
6. Use this equipment **ONLY** for its intended use as described in this manual. Do not use corrosive chemicals or vapors in this equipment. This type of oven is specifically designed to heat, cook, or dry food. It is not designed for industrial or laboratory use.
7. As with any equipment, **CLOSE SUPERVISION** is necessary when used by **CHILDREN**.
8. See door cleaning instructions on page A-4 of this owners manual.
9. **DO NOT** heat baby bottles in oven.
10. Baby food jars shall be open when heated and contents stirred or shaken before consumption, in order to avoid burns.
11. **DO NOT** operate this equipment if it has a damaged cord or plug, if it is not working properly, or if it has been damaged or dropped.
12. This equipment, including power cord, must be serviced **ONLY** by qualified service personnel. Special tools are required to service equipment. Contact nearest authorized service facility for examination, repair, or adjustment.
13. **DO NOT** cover or block louvers or other openings on equipment.
14. **DO NOT** store this equipment outdoors. **DO NOT** use this product near water – for example, near a kitchen sink, in a wet basement, a swimming pool, or a similar location.
15. **DO NOT** immerse cord or plug in water.
16. Keep cord **AWAY** from HEATED surfaces.
17. **DO NOT** let cord hang over edge of table or counter.
18. For commercial use only.

## PRECAUTIONS TO AVOID POSSIBLE EXPOSURE TO EXCESSIVE MICROWAVE ENERGY

- A. **DO NOT** attempt to operate this oven with the door open since open door operation can result in harmful exposure to microwave energy. It is important not to defeat or tamper with the safety interlocks.
- B. **DO NOT** place any object between the oven front face and the door too allow soil or cleaner residue to accumulate on sealing surfaces.
- C. **DO NOT** operate the oven if it is damaged. It is particularly important that the oven door close properly and that there is no damage to the:
  1. door (bent)
  2. hinges and latches (broken or loosened)
  3. door seals and sealing surfaces.
- D. The oven should not be adjusted or repaired by anyone except properly qualified service personnel.

## SAVE THESE INSTRUCTIONS

# IMPORTANT SAFETY INSTRUCTIONS



## WARNING

To avoid risk of fire in the oven cavity:

- a. DO NOT overcook food. Carefully attend oven when paper, plastic, or other combustible materials are placed inside the oven to facilitate cooking.
- b. Remove wire twist-ties from paper or plastic bags before placing bag in oven.
- c. If materials inside the oven ignite, keep oven door CLOSED, turn oven off and disconnect the power cord, or shut off power at the fuse or circuit breaker panel.
- d. DO NOT use the cavity for storage. DO NOT leave paper products, cooking utensils, or food in the cavity when not in use.



## WARNING

Liquids such as water, coffee, or tea are able to be overheated beyond the boiling point without appearing to be boiling due to surface tension of the liquid. Visible bubbling or boiling when the container is removed from the microwave oven is not always present. THIS COULD RESULT IN VERY HOT LIQUIDS SUDDENLY BOILING OVER WHEN A SPOON OR OTHER UTENSIL IS INSERTED INTO THE LIQUID. To reduce the risk of injury to persons:

- i) Do not overheat the liquid.
- ii) Stir the liquid both before and halfway through heating it.
- iii) Do not use straight-sided containers with narrow necks.
- iv) After heating, allow the container to stand in the microwave oven for a short time before removing the container.
- v) Use extreme care when inserting a spoon or other utensil into the container.



## CAUTION

To avoid personal injury or property damage, observe the following:

1. Do not deep fat fry in oven. Fat could overheat and be hazardous to handle.
2. Do not cook or reheat eggs in shell or with an unbroken yolk using microwave energy. Pressure may build up and erupt. Pierce yolk with fork or knife before cooking.
3. Pierce skin of potatoes, tomatoes, and similar foods before cooking with microwave energy. When skin is pierced, steam escapes evenly.
4. Do not operate equipment without load or food in oven cavity.
5. Microwave popcorn should not be popped in oven.
6. Do not use regular cooking thermometers in oven. Most cooking thermometers contain mercury and may cause an electrical arc, malfunction, or damage to oven.
7. Do not use metal utensils in oven.
8. Do not use aluminum foil in oven
9. Never use paper, plastic, or other combustible materials that are not intended for cooking.
10. When cooking with paper, plastic, or other combustible materials, follow manufacturer's recommendations on product use.
11. Do not use paper towels which contain nylon or other synthetic fibers. Heated synthetics could melt and cause paper to ignite.
12. Do not heat sealed containers or plastic bags in oven. Food or liquid could expand quickly and cause container or bag to break. Pierce or open container or bag before heating.
13. To avoid pacemaker malfunction, consult physician or pacemaker manufacturer about effects of microwave energy on pacemaker.
14. An authorized servicer MUST inspect equipment annually. Record all inspections and repairs for future use.

## SAVE THESE INSTRUCTIONS

# 2 **AXP20 / MXP20, AXP22 / MXP22** **60 Hz Specifications**

## **Installation**

- Unpacking the oven
- Oven Clearances

## **Power Specification**

- Input
- Output
- Consumption

## **Dimensions**

- Weight

# Installation

## STEP 1 - Unpack Oven

- Inspect oven for damage such as dents in door or inside oven cavity.
- Report any dents or breakage to source of purchase immediately.  
**Do not attempt to use oven if damaged.**
- Remove all packing materials from oven interior.
- If oven has been stored in extremely cold area, wait a few hours before connecting power.

## STEP 2 - Place Oven on Counter

- Recommended countertop surface depth is 26" (66 cm).
- Do not install oven next to or above source of heat, such as pizza oven or deep fat fryer. This could cause oven to operate improperly and could shorten life of electrical parts.
- Do not block or obstruct oven filter. Allow access for cleaning.
- Install oven on level countertop surface.
- Outlet should be located so that plug is accessible when oven is in place.

## STEP 3 - Install Rack

- Install oven rack
  1. Oven cavity must be cool to touch.
  2. Place rack in oven with rear guard positioned toward the back of the oven.
- **DO NOT** cook food directly on floor of oven.

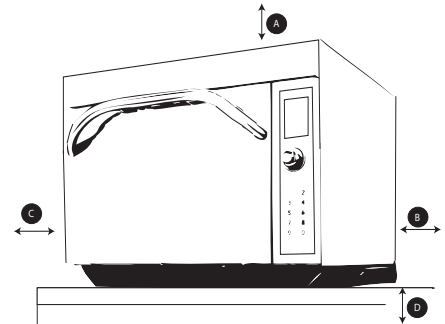

### Oven Clearances

- A—For North American (UL/CSA) models, allow at least 2" (5.1 cm) of clearance around top of oven. For International (50 Hz) models, allow at least 7" (18 cm) of clearance around top of oven. Proper air flow around oven cools electrical components. With restricted air flow, oven may not operate properly and life of electrical parts is reduced.
- B—Allow at least 2" (5.1 cm) between air discharge on back of oven and back wall.
- C—Allow at least 2" (5.1 cm) of clearance around sides of oven.
- D—Install combination oven so oven bottom is at least 3 feet (91.5 cm) above floor.

# Specifications AXP20, MXP20, AXP22, MXP22

<b>Power Source</b>	
<b>Voltage AC</b>	208/230 VAC
<b>Amperage (Single Unit)</b>	30 A
<b>Frequency</b>	60 Hz
<b>Single Phase, 3 wire grounded</b>	X
<b>Receptacle</b>	6-30R
<b>Plug</b>	6-30P
<b>Power Output – Microwave</b>	
<b>Nominal microwave energy (IEC705)</b>	2200 Watts
<b>Minimum Temperature Rise (<math>\Delta T</math>)</b>	22°F / 12°C
<b>Operating Frequency</b>	2450 MHz
<b>Power Consumption</b>	5700 Watts
<b>Microwave only</b>	4200 Watts
<b>Convection fan</b>	425 Watts / 6200 RPM
<b>Radiant heater</b>	3000 Watts
<b>Convection heater</b>	2000 Watts
<b>Combination</b>	5300Watts
<b>Dimensions</b>	
<b>Cabinet (in / cm)</b>	
<b>Width</b>	25"      63.5 cm
<b>Height</b>	20.25"      51 cm
<b>Depth (includes bracket on back)</b>	25.625"      65 cm
<b>Oven Interior (in / cm) – useable space</b>	
<b>Width</b>	16.0"      41 cm
<b>Height</b>	7.75"      20 cm
<b>Depth</b>	15.0"      38 cm
<b>Weight (lbs. / kg)</b>	
<b>Uncrated</b>	150 lbs.      68 kg
<b>Crated</b>	175 lbs.      79 kg

# **3** | **AXP20 / MXP20, AXP20/ MXP22** **60 Hz Quick Start** **Reference Guide**

Refer to Product Safety Manual for Safety Statements. Complete Owner's Manual available online

## Oven Controls

The oven touch screen displays menu options. The dial, keypad and touch screen can be used to navigate through onscreen menus. **This guide will focus primarily on the dial control for menu navigation.**

### Dial Menu Navigation

1. Rotate the dial clockwise to scroll through menu options.
2. The current menu selection will be highlighted.
3. To select menu item, press dial.

The icons below will be used throughout this guide to indicate when menu navigation other than the dial is necessary.

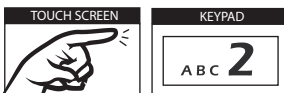

## Selecting a Function



Highlight menu items by rotating the dial. Push the dial to select.

## Getting Started

### Preheating the Oven

This oven can be set to a preheat temperature between 200°F and 520°F (95°C and 270°C).

1. Oven must be plugged in.
2. The Preheat Temperature the oven is set to will appear at the top of the display.
2. Rotate the dial to highlight the PRESS TO PREHEAT button and press to select.
3. Oven Preheating status menu will display until oven reaches preheat temperature. The main menu screen will then appear.

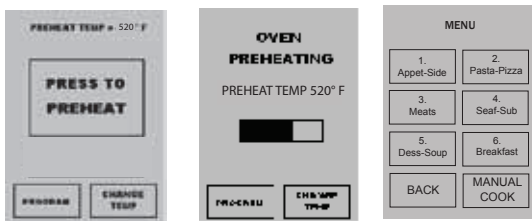

### Programming or Changing Preheat Setting To program the preheat setting:

1. Oven must be plugged in.
2. Rotate dial until CHANGE TEMP is highlighted and press dial to select.
3. Rotate dial until desired temperature is displayed and press knob to select.

## Cooking with Pre-programmed Pads

To cook food using pre-programmed menu items

1. After oven has preheated to the desired temperature, highlight desired menu category by rotating the dial and press to select.
2. Highlight menu item group and press dial to select.
3. Highlight item.
4. Open oven door, place food in oven and close door.
5. Push dial to start cooking process.
6. At end of cooking cycle, oven beeps and displays "DONE. REMOVE FOOD FROM OVEN"

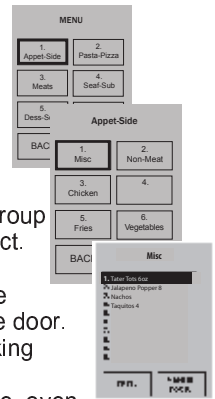

## Using MANUAL COOK

To cook food using a specific entered time and power level.

1. After oven has preheated, Select MANUAL COOK option on the menu screen by rotating dial and press to select.
2. For Stage 1, input desired cooking time using the dial. Press dial.
3. Input desired temperature. Press dial.
4. Rotate dial until desired microwave cooking power is displayed and press.
5. Rotate dial until desired cooking fan speed is displayed. Press to select.
6. Rotate dial until desired heating setting is displayed and press.
7. Repeat steps 2-6 for each cooking stage, if more than one stage is necessary.
8. Place food in oven as indicated on the oven display.
9. Press start pad or touch screen to start.

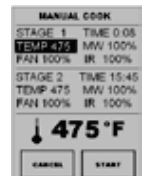

10. At end of cooking cycle, oven beeps and displays "DONE. REMOVE FOOD FROM OVEN".

Note: To interrupt cooking cycle, open door. To resume cooking, close door and press start.

## ACCESSING THE PROGRAM MENU

1. To access the PROGRAM MENU, select the BACK button on the main menu screen.



2. Then select PROGRAM from the READY screen.

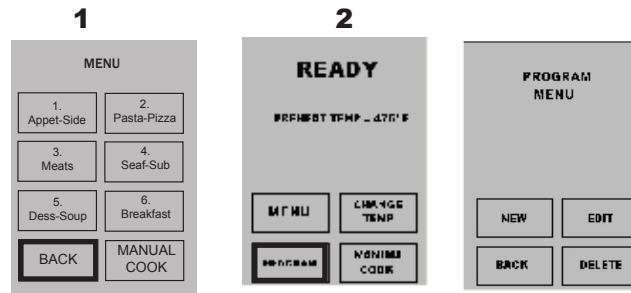

## PROGRAM MENU OVERVIEW

- NEW** – Add a new menu item
- BACK** – Go to previous screen
- EDIT** – Change an existing menu item
- DELETE** – Delete an existing menu item



## ADDING OR CHANGING MAIN MENU LEVEL OR ITEM GROUP MENU

1. From PROGRAM MENU rotate dial to select NEW to add an item or EDIT to edit an existing menu item.

2. From the MENU or MENU ITEM GROUP screen select EDIT MENU (border will flash).

3. Using the dial, highlight pad you wish to program or edit and press dial to select.

4. Enter name for menu using keypad digits for letters, numbers and symbols. **[For example: Press Keypad “2” three times for letter “c”]**

When the correct letter is displayed, wait until cursor moves to the next space. If a correction is necessary, press CLEAR to erase one character at a time.



Keypad Press	Character Display
1	“, -, #, 1
2	a, b, c, A, B, C, 2
3	d, e, f, D, E, F, 3
4	g, h, i, G, H, I, 4
5	j, k, l, J, K, L, 5
6	m, n, o, M, N, O, 6
7	p, q, r, s, P, Q, R, S, 7
8	t, u, v, T, U, V, 8
9	w, x, y, z, W, X, Y, Z, 9
0	&, %, \$, 0

### EDITING MAIN MENU CATEGORY SCREEN

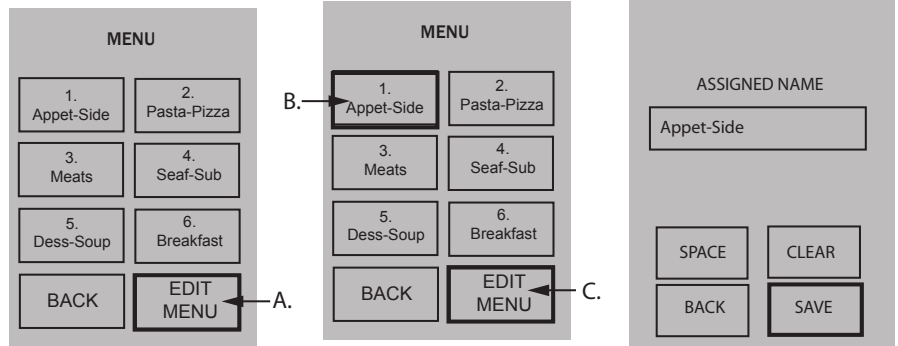

### EDITING FOOD CATEGORY SCREEN

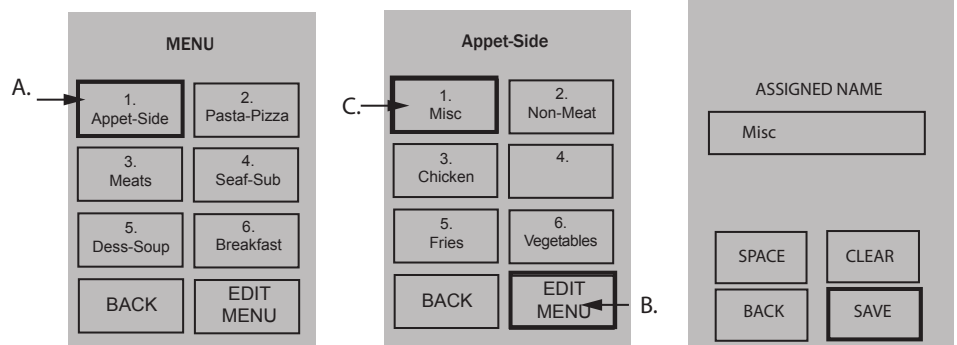

4. Highlight SAVE button and press dial to select when item is complete. If you do not wish to save the entry, press the back button to return the oven to Program Edit without saving.
5. Press BACK button to return to READY display.

## ADDING ITEM TO ITEM MENU

1. Select NEW from the PROGRAM MENU to add a new item or EDIT to edit item.
2. Select category you wish to change from MAIN MENU and ITEM GROUP Menus.
3. At the ITEM MENU, rotate dial until item to be added or changed is highlighted and press dial. The confirm screen will appear and ask you to confirm the change you're making. Touch CREATE or press knob to CONFIRM OVERWRITE. Note - When editing an item the CONFIRM OVERWRITE screen does not appear.



### CREATING NEW ITEM GROUP

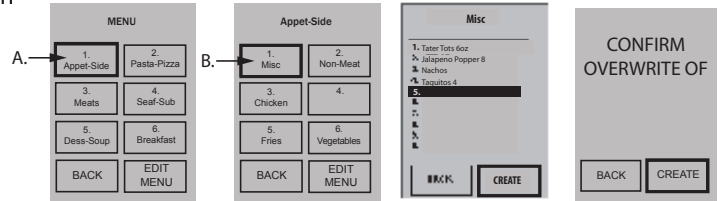

The cooking program menu will appear

4. For Stage 1 rotate the dial to input desired time.



5. Input desired temperature.



6. Input desired microwave power



7. Input desired fan speed



8. Input desired (IR) heating setting.



9. Press SAVE button on screen.



If necessary, repeat steps 4 through 8 for stages 2, 3, and 4.

10. Enter Item Names using letters on keypad and touch SAVE.



Keypad Press	Character Display
1	“, -, #, 1
2	a, b, c, A, B, C, 2
3	d, e, f, D, E, F, 3
4	g, h, i, G, H, I, 4
5	j, k, l, J, K, L, 5
6	m, n, o, M, N, O, 6
7	p, q, r, s, P, Q, R, S, 7
8	t, u, v, T, U, V, 8
9	w, x, y, z, W, X, Y, Z, 9
0	&, %, \$, 0

## COOKING PROGRAM MENU

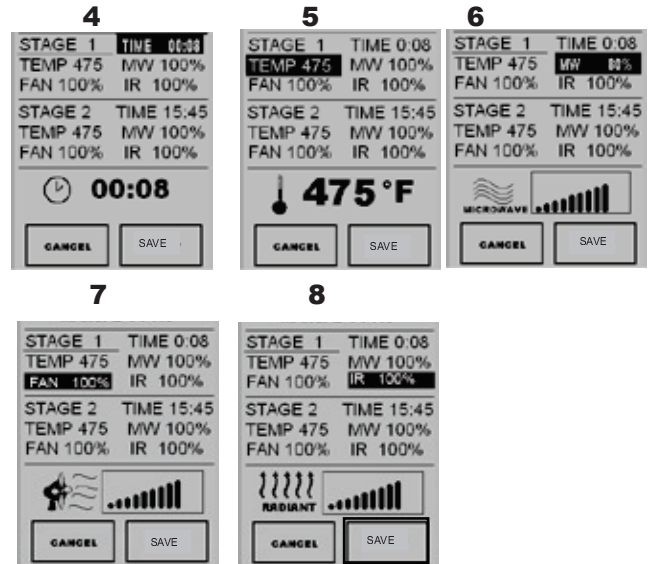

# AXP20 / MXP20

## Quick Start Reference Guide | High Speed Commercial Combination Oven

Refer to Product Safety Manual for Safety Statements. Complete Owner's Manual available online

### Changing User Options



There are several options you can change to customize the operation of the oven for your business. The table below shows these options; the factory setting is shown in bold type.

- Oven must be off. To turn oven off, press OFF button on Keypad. Off
- Press and hold "2" keypad for three seconds.
- Choose option by turning dial to highlight desired option. Press knob and the next option will be highlighted.
- Press SAVE when finished.

Option #	Setting Name	Options
1	Digit Entry	<b>Single digit entry</b>
		Double digit entry
2	Menu Setting	1 Level
		2 Levels
		<b>3 Levels</b>
3	Manual Lock	<b>Manual cooking allowed</b>
		Manual cooking not allowed
4	Program Lock	<b>Changes to programs allowed</b>
		Password needed
5	Door Open	Opening door resets timer
		<b>Opening door pauses cook cycle</b>
6	Keybeep	Off
		<b>On</b>
7	Keybeep Volume	Low
		Medium
		<b>High</b>
8	End of Cycle Beep	Continuous until door is opened
		Three beeps once
		<b>Three beeps repeating</b>
9	Keyboard Window	Off
		30 Seconds
		<b>60 Seconds</b>
		120 Seconds
10	Preheat Warnings	<b>Off</b>
		Warn if oven not at temp
11	Temperature Scale	Temperatures are displayed in °F for 60 Hz models
		Temperatures are displayed in °C for 50 Hz models
12	Clean Filter	Off
		<b>Displays every 7 days</b>
		Displays every 30 days
		Displays every 90 days
13	Auto Menu	From Preheat, go to Ready
		<b>From Preheat, go to Menu</b>
14	Magnetron Control	<b>No individual tube programming</b>
		Individual Tube Programming
15	Microwave Only Mode	<b>No microwave only mode</b>
		Allow microwave only mode
16	Manual Program Save	Do not save after manual cook
		<b>Save after manual cook</b>
17	Automatic Shut Off	2 Hours
		<b>4 Hours</b>
		8 Hours
		Disable
18	Data Transfer	<b>Begin Transfer: Card to Oven</b>
		Begin Transfer: Oven to Card
19	Preheat Temperature*	Enter Temperature in 5° increments 200°F (95°C) - 520°F (270°C)

\* Option 19 not on all models

**CLEAN FILTER**

**CLEAN FILTER  
REMOVE THE AIR  
FILTERS AND CLEAN**



AIR FILTERS  
ON SIDES

**THIS MESSAGE WILL  
CONTINUE TO BE SHOWN  
FOR 24 HOURS**

When this message displays, clean the air filter thoroughly. **Cleaning the air filter will not shut off the message.** The message will automatically stop displaying after 24 hours.

Depending on microwave use and environmental conditions, the filter may need to be cleaned more or less frequently. Once the frequency is determined, set the option for the appropriate time frame.

Air filter and vents must be cleaned regularly to prevent overheating of the oven. Refer to Owner's Manual for complete cleaning instructions.

# AXP20 / MXP20

## EZCard Programming

To program the oven using the EZCard:

Oven must be in Standby mode (Preheat must be OFF)

1. Open protective cover from bottom of keypad.
2. Insert the EZCard into the slot located below the vertical keypad.  
**Note:** The EZCard can be inserted forwards or backwards.
3. From Standby, press and hold the “2” pad to go to “User Options”.
4. Go to Option #18 by pressing “Prev Option” on the screen or repeatedly pressing “Next Option”
5. Select the desired operation by highlighting “Transfer card to oven” or “Transfer oven to card” with the knob.
6. Press the “Start” pad to begin the transfer (The screen will indicate transferring and indicate done when transfer is complete.)
7. Press the SAVE pad to complete the process.  
**Note:** You can exit from programing the oven by pressing “off” keypad.
8. Remove EZCard and close the protective cover.

Standby Mode



# Touch Panel Symbol Description AXP22 / MXP22

The oven screen displays menu choices. The keypad is used to navigate through onscreen menus.

The icons below will be used throughout this guide to indicate menu navigation.



## ON / OFF Keypad

- Press to preheat oven or turn oven off. (Fan will continue to run if temperature is over 200°F / 95°C).

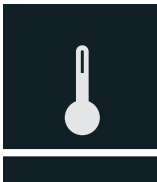

## TEMPERATURE Keypad

- Press to check set temperature
- Press to change temperature.
- Press Number keypads to enter or change temperature.
- Press Enter to save.

## Menu Screen



Use Scroll Up and Scroll Down to highlight food categories.



## PROGRAM Keypad

- Press to program new product or change existing programs.
- Press to start data key transfer.
- Press to change password.



## EDIT

- Select to program new product or change existing programs.



## DELETE

- Select to delete programs.



## MANUAL COOK Keypad

- Press for manual cooking.

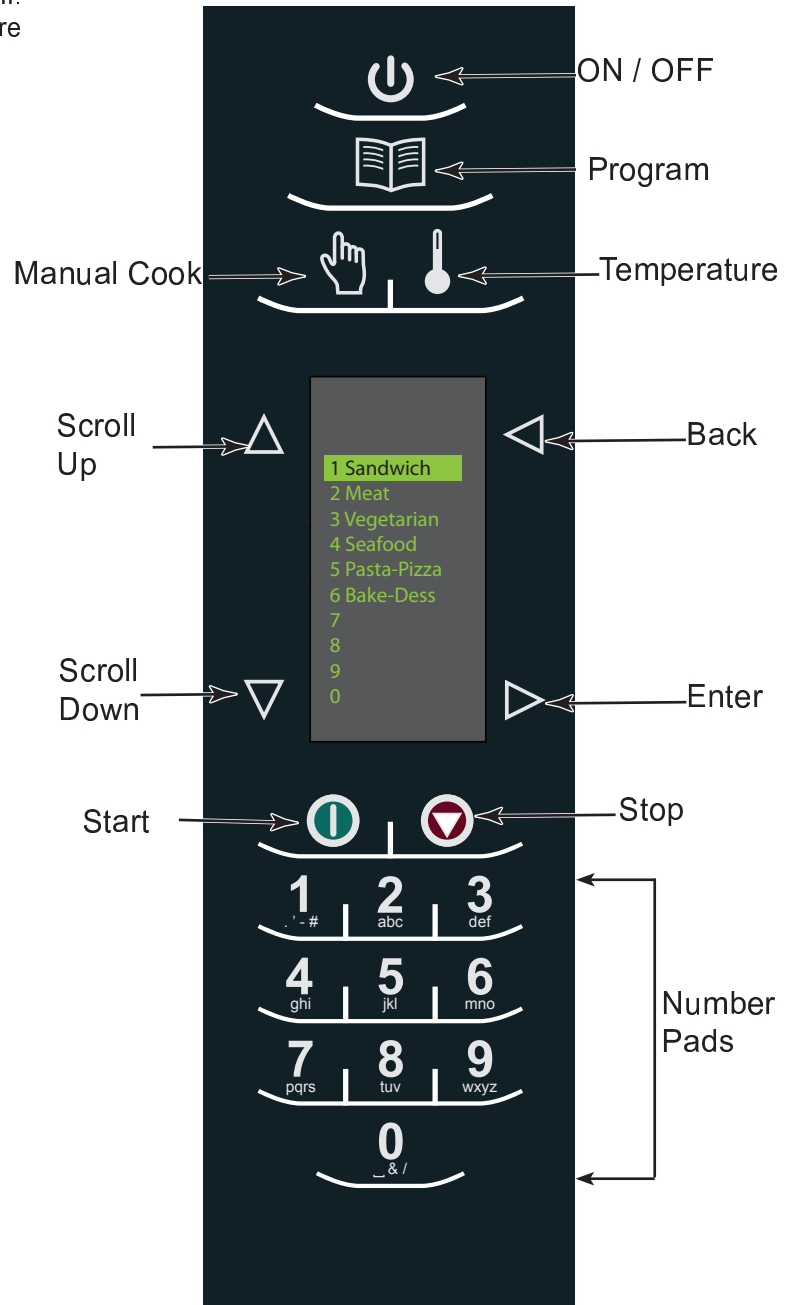

# Touch Panel Symbol Description AXP22 / MXP22



## SCROLL UP Keypad

- Press to change setting or move up to another setting.
- Press to move up to another highlighted area.



## SCROLL DOWN Keypad

- Press to change setting or move down to another setting.
- Press to move down to another highlighted area.



## BACK Keypad

- Press repeatedly to return to main menu.
- Press to go to previous screen.
- Press repeatedly to exit program mode.
- Press to erase a character.



## ENTER Keypad

- Press to save a menu.
- Press to save a MANUAL COOK program.
- Press to go to next screen.
- Press to save a name.
- Press to confirm deletion of a menu item.



## START Keypad

- Press to start cooking cycle.
- Press to save option in option mode.



## STOP / RESET Keypad

- Press to stop cooking cycle.
- Press to exit option in option mode.



## NUMBER Keypads

- Press to input temperature settings.
- Press to select menu items.
- Press to input names of menu items.



## Preheat Temperature Warning Icon:

- Oven not up to temperature setpoint.
- Preheat temperature warning will flash when programming cook cycle until temperature setpoint is met.



## Oven Cooling Mode Icon:

- The oven fan will continue to run to cool the oven. The oven Cooling Mode Icon appears and stays on until the oven temperature is below 200°F (95°C).
- To avoid damage to the convection motor do not turn off power by unplugging the unit or shutting off the power breaker until the fan stops.



## Oven Off Icon:

- The Oven Off Icon appears for 5 minutes then the display goes blank.



## Oven Temperature Out of Range:

- When oven temperature is out of range of a cooking program set point. A line will be thru that item or items preventing it to be selected. Place the oven in Program Mode to view temperature set point of that cooking program. If the temperature of the oven needs to be changed after reviewing temperature for the cooking program, exit programming mode and change oven temperature.

## View Temperature



Program



EDIT

## Change Oven Temperature



## Quick Start Reference Guide | High Speed Commercial Combination Oven

Refer to Product Safety Manual for Safety Statements. Complete Owner's Manual available online

The oven screen displays menu options. The keypad is used to navigate through onscreen menus.

The icons below will be used throughout this guide to indicate menu navigation.

Use Scroll Up and Scroll Down to highlight food categories

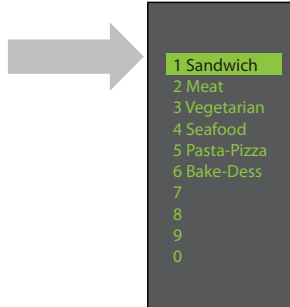

### COOKING MENUS

Your ovens ships with the cooking screens set to three menu levels.

1. The **MENU CATEGORIES** screen highlights product categories.
2. The **FOOD CATEGORIES** screen features products within the main menu category.
3. The **MENU ITEM** screen features products within the food category screen.

*NOTE: The oven can be set to operate with 1, 2, or 3 menu levels see user options for more details.*

The **ITEM MENU** breaks the item group menu down further allowing you to input quantities, different food types, etc.

### THREE MENU LEVELS

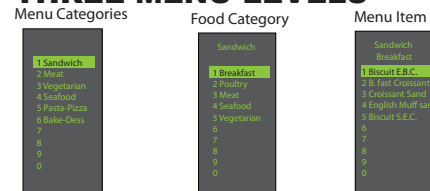

### TWO MENU LEVELS

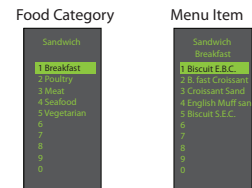

### ONE MENU LEVEL

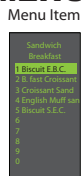

Manual Cook

Scroll Up

Scroll Down

Start

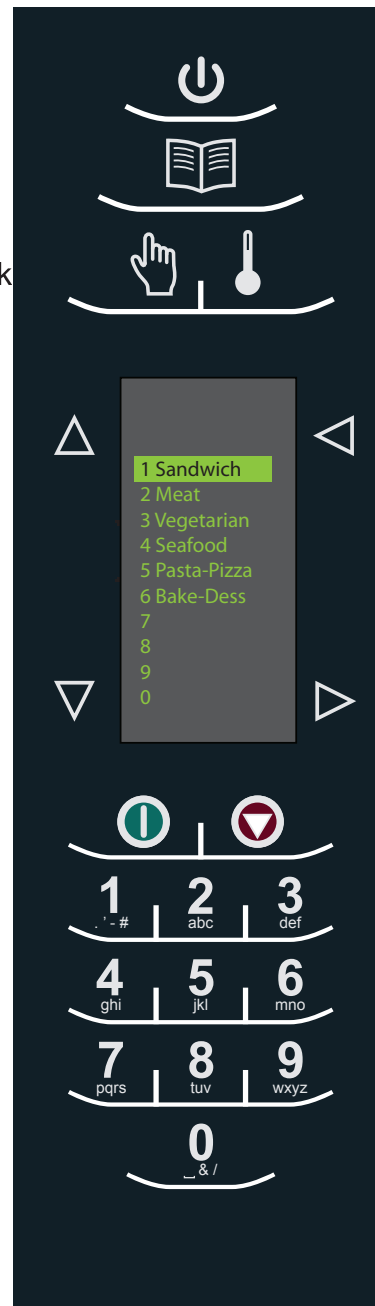

ON / OFF

Program

Temperature

Back

Enter

Stop

Number Pads

# Quick Start Reference Guide | High Speed Commercial Combination Oven

After the oven has preheated, the menu appears. The oven comes preprogrammed with several menu items to simplify cooking.

## MAIN COOKING MENU

Examples of Preprogrammed Menu Items Include:

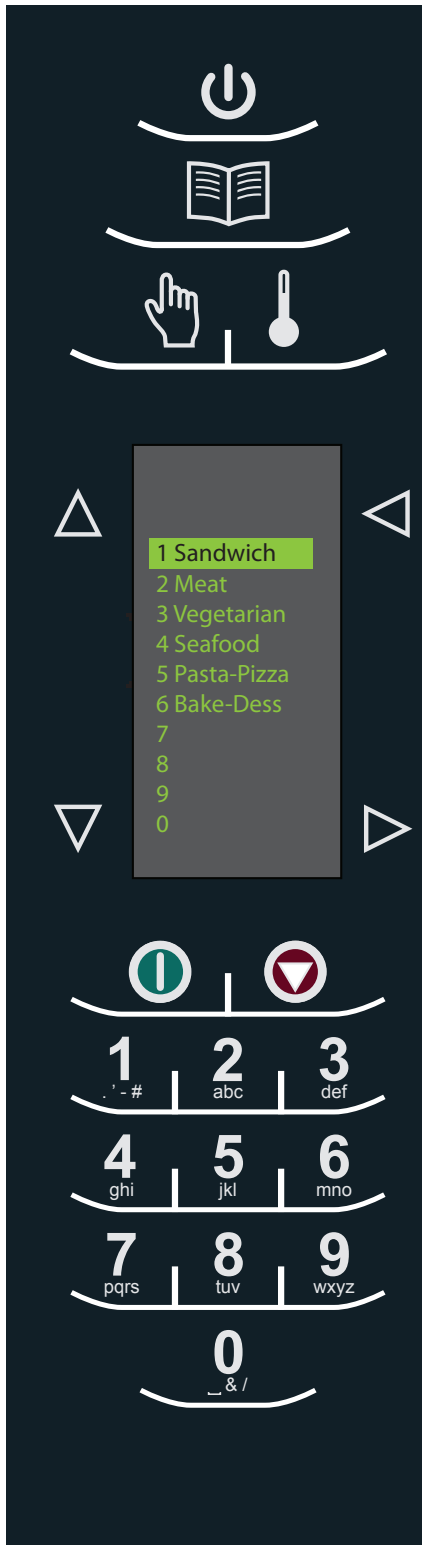

### 1. Sandwich

- Breakfast
- Poultry
- Meat
- Seafood
- Vegetarian

### 2. Meat

- Poultry
- Beef
- Pork
- Appetizers
- Breakfast

### 3. Vegetarian

- Breakfast
- Lunch
- Vegetables
- Appetizers
- Potatoes

### 4. Seafood

- Fish
- Shellfish
- Misc

### 5. Pasta-Pizza

- Small/Large Pizza
- Pasta
- Miscellaneous

### 6. Bakery-Desserts

- Bread
- Desserts
- Snacks
- Breakfast
- Sweet

← Back

← Enter

## Cooking with Preprogrammed Pads

To cook food using preprogrammed menu items

1. After oven has preheated to the desired temperature. Scroll or press number to choose desired food category from menu.
2. Choose menu item group and press Enter to select.
3. Highlight item you wish to cook.

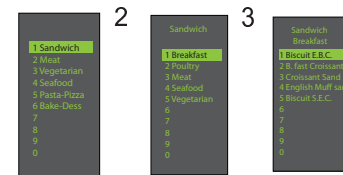

**Note:** If there is a line through the menu item, then preheat temperature is different than menu item preset temperature. The control will not allow you to select that item.



4. Open oven door, place food in oven and close door.
5. Press Enter to start cooking process.

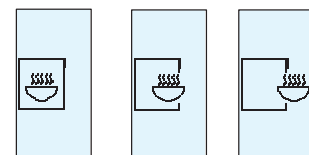

6. At end of cooking cycle, oven beeps and displays animation at right to indicate food can be removed.

**Note:** Menu Items may vary by model.



## Quick Start Reference Guide | High Speed Commercial Combination Oven

### Using MANUAL COOK (Option 4 has to be set to allow manual cooking. See options section)

Use Manual cooking when a specific time and cooking power levels are desired. It's very useful when you are experimenting with new food items. Maximum cook time is 100 minutes. Microwave, Fan and IR can be set in 11 different power levels between 0-100% at 10% increments.

- After oven has preheated to desired temperature (200-520°F / 95-270°C), press Manual Cook keypad.



- Use Scroll Up  and Scroll Down  keypad to move between cooking elements and time
- For Stage 1, enter cooking time using the number pads (up to 100 minutes). Press Scroll Down keypad to move to the following cooking element.

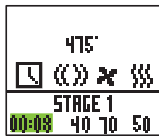

- Enter desired microwave power (press 0 (for 0%), 1 (10%), press 5 (50%)... and press 1 twice for full power (100%). Press Scroll Down keypad to move to the following cooking element

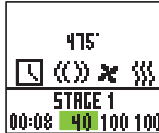

- Input desired fan speed using number keypad.

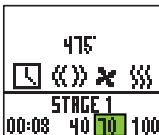

- Enter desired Infrared (IR) power (press 0 (for 0%), 1 (10%), press 5 (50%)... and press 1 twice for full power (100%).

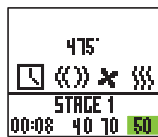

- Repeat steps 2-6 for each cooking stage, if more than one cooking stage is necessary.
- Place food in oven.

- Press Start keypad to begin cooking. The display counts down. The food category is displayed and the word Manual is in the display.



- At end of cooking cycle, oven beeps and displays animation below:

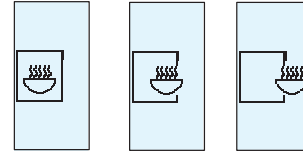

- Remove food from oven.



*Note: To interrupt cooking cycle, open door. To resume cooking, close door and press start.*



### How to Save A Manual Cook Program to the Menu

If satisfied with the cooking results achieved from manual cooking, save the manual cook item:

- To save, press Enter  keypad.



**Note:** Option 5 must be set to save after manual cook.

- Highlight Menu Category by using Scroll Up  or Scroll Down  keypad or create new Menu Category name. Press Enter  keypad.

- Highlight food category by using Scroll Up  and Scroll Down  keypad to select open menu location.

- In the Menu Item screen, highlight the location where you wish to add the new name.

- When new location is highlighted Press Program  keypad.

- Use Number  keypads to enter item name. Use Back  keypad to delete any mistakes. This step needs to be repeated for each menu level. See user option 2 for text case options.



- Press Enter  keypad when finished.

- To exit Manual Cook mode, press Back  keypad repeatedly to take you to the Main Menu screen.



## Quick Start Reference Guide | High Speed Commercial Combination Oven

### ACCESSING THE PROGRAM MENU

1. To access the PROGRAM mode, press the Program  keypad.

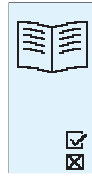
2. Then select Edit  with Scroll Up  or Scroll Down  from the screen.



3. Press Enter  then select the food category, food item to be programmed using the Scroll Up  or Scroll Down  keypad.

### PROGRAM MENU OVERVIEW

**PROGRAM**  Add a new menu item

**ENTER**  To save or go to next screen







**BACK**  Go to previous screen

**SCROLL UP**  or **SCROLL DOWN** 



**EDIT**  Change an existing menu item

**DELETE**  Delete an existing menu item

### EDITING OR ADDING MENU PROGRAM SETTINGS

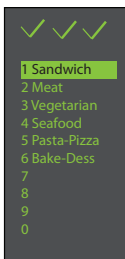

1. Press the Program  keypad.
2. Highlight Edit with Scroll Up  or Scroll Down  keypad.
3. Press the Enter  keypad
4. Use the Scroll Up  or Scroll Down  keypad to highlight Menu Category and/or Food Category where menu item to edit is saved. Press Enter  keypad.





5. At the Menu item screen, use Scroll Up  or Scroll Down  keypad to highlight the desired item to edit.

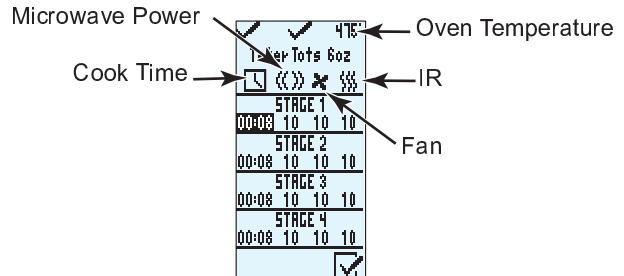

6. Press the Enter keypad and cook settings will appear.

7. Use Scroll Up  or Scroll Down  keypad to Select Temperature, Time, Microwave %, Fan% and IR% setting. Use number keypads to enter the time, temperature or cooking powers. For MW, Fan or IR, press 0 for 0%, 1 for 10%..... 9 for 90% or 1 twice for 100%.













8. When cook settings are complete press Enter  keypad.

9. Press Back  keypad repeatedly to exit program mode.

## Quick Start Reference Guide | High Speed Commercial Combination Oven

### EDITING OR ADDING NEW NAMES FOR MENU CATEGORY OR FOOD CATEGORY OR MENU ITEM

1. Press the Program  keypad.
2. Highlight Edit  with Scroll Up  or Scroll Down  keypad and press Enter  keypad.
3. Using the Scroll Up  or Scroll Down  keypad to highlight location where new category or item will be placed. (In order to navigate to the following screen, Scroll Up  and Scroll Down  keypad to highlight desired menu and press Enter  keypad). For example:

#### I. Editing Name in Menu Category Screen

- A. Highlight Item
- B. go to Step 4



#### II. Editing Name in Food Category

- A. Highlight desired Menu Category
- B. Press Enter



- C. Highlight desired Food Category



- D. Go to Step 4

#### III. Editing / Adding Name in Menu Item

In order to add program settings, you must name your item first.

- A. Highlight desired Menu Category

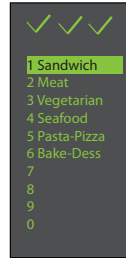

- B. Press Enter

- C. Highlight desired Food Category



- D. Press Enter

- E. Highlight desired Menu Item



- F. Go to Step 4

4. Press the Program  keypad.

5. Enter name for category or item using keypad digits for letters, numbers and symbols. **[For example: Press Keypad “2” three times for letter “c”]**

When the correct letter is displayed, wait until cursor moves to the next space. If a correction is necessary, press back  to erase one character at a time. See user option 2 for text case options page 14.

6. Press the Enter  keypad to save name. and it will take you to the next screen. If you are adding or editing a menu item (last screen), after pressing enter will take you to the program setting screen.







7. Press Back  keypad repeatedly to exit program mode.





















# AXP22 / MXP22

## Quick Start Reference Guide

### High Speed Commercial Combination Oven

There are several options you can change to customize the operation of the oven for your business. The table below shows these options; the factory setting is shown in bold type.

- Oven must be off. To turn oven off, press ON/OFF  keypad.
- Press and hold "2" keypad until option screen appears.
- Choose option by pressing Enter  keypad then use Scroll Up  and Scroll Down  keypad to select option to highlight desired option.
- Press Start  keypad to save and press Stop / Reset  to exit options mode.
- Option 6, if "Password Needed" is highlighted press Program keypad to view or edit password.

Options#	Setting Name	Options
01	Digit Entry	 <b>Single digit entry</b>
		 Double digit entry
02	Text Case	 <b>Caps</b>
		 Lower case
		 <b>Mixed</b>
03	Menu Setting	01=10 Items
		02 =100 Items
		<b>03 = 360 items</b>
04	 (Manual) Cook	<input checked="" type="checkbox"/> <b>Manual cooking allowed</b>
		<input type="checkbox"/> Manual cooking not allowed
05	 (Manual) Save	<input checked="" type="checkbox"/> <b>Save after manual cook</b>
		<input type="checkbox"/> Do not save after manual cook
06	Program Password	<input checked="" type="checkbox"/> <b>Password needed</b>
		<input type="checkbox"/> <b>Changes to programs allowed</b>
07	Door Reset	<input checked="" type="checkbox"/> <b>Opening door resets timer</b>
		<input type="checkbox"/> <b>Opening door pauses cook cycle</b>
08	Keyboard Activation	<input type="checkbox"/> Off
		 30 Seconds
		 <b>60 Seconds</b>
		 120 Seconds
09	 Keybeep	<input checked="" type="checkbox"/> <b>On</b>
		<input type="checkbox"/> Off
10	 Keybeep Volume	<input type="checkbox"/> Low
		<input type="checkbox"/> Medium
		<input checked="" type="checkbox"/> <b>High</b>
11	 End Of Cycle Beep	<input type="checkbox"/> Three beeps once
		<input checked="" type="checkbox"/> <b>Three beeps repeating</b>
		<input type="checkbox"/> Continuous until door is opened
12	 Preheat Warning	<input checked="" type="checkbox"/> Warn if oven not at temp
		<input type="checkbox"/> <b>Off</b>
13	 Temperature Scale	<input checked="" type="checkbox"/> <b>Temperatures are displayed in °F for 60Hz models</b>
		<input type="checkbox"/> Temperatures are displayed in °C for 50Hz models
14	Clean Filter Reminder	<input type="checkbox"/> Off
		<input type="checkbox"/> <b>Displays every 7 days</b>
		<input type="checkbox"/> Displays every 30 days
		<input type="checkbox"/> Displays every 90 days
15	 (Microwave) Only	<input type="checkbox"/> Allow microwave only mode
		<input checked="" type="checkbox"/> <b>No microwave only mode</b>
16	Auto Off	<input type="checkbox"/> Disable
		<input type="checkbox"/> 2 Hours
		<input checked="" type="checkbox"/> <b>4 Hours</b>
		<input type="checkbox"/> 8 Hours
17	Data Transfer	<input type="checkbox"/>  <b>Begin Transfer: Card to Oven. Press Program Keypad</b> 
		<input type="checkbox"/>  <b>Begin Transfer: Oven to Card. Press Program Keypad</b> 

### CLEAN FILTER

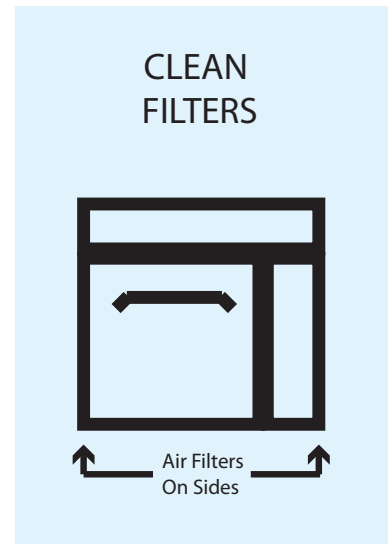

When this message displays, clean the air filter thoroughly. **Cleaning the air filter will not shut off the message.** The message will automatically stop displaying after 24 hours.

Depending on microwave use and environmental conditions, the filter may need to be cleaned more or less frequently. Once the frequency is determined, set the option for the appropriate time frame.

Air filter and vents must be cleaned regularly to prevent overheating of the oven. Refer to Owner's Manual for complete cleaning instructions.

# AXP22 / MXP22





## USB Flash Drive Programming

### To program the oven using standard flash drive:

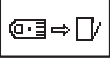
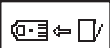

Oven must be in Off mode (Preheat must be OFF)

1. Remove protective cover from bottom of keypad.
2. Insert the flash drive into the slot located below the keypad.

**Note:** After inserting flash drive in USB port wait at least **6 seconds** before proceeding.

3. Press and hold the “2” pad to go to “User Options”.
4. Go to Option #17 by pressing “Back  ” or repeatedly pressing “Enter  ”
5. Select the desired operation by highlighting “Transfer card to oven  ” or “Transfer oven to flash drive  ” with the Scroll Up  or Scroll Down  keypad.

**Note:** Wait at least **6 seconds** before proceeding to Step 6.

6. Press the “Program  ” pad to begin the transfer (The screen will indicate “TRANSFERRING” and indicate “DONE” when transfer is complete.) **Note:** The screen will indicate “ NO CARD” if the data key is not detected.
7. Remove flash drive and reinsert the protective cover.

# **4 | AXP20 / MXP20, AXP22 / MXP22 60 Hz Oven Construction**

# OVEN CONSTRUCTION PANELS (TOP & SIDE)

To remove side panels loosen the three top T-15 torx screws.

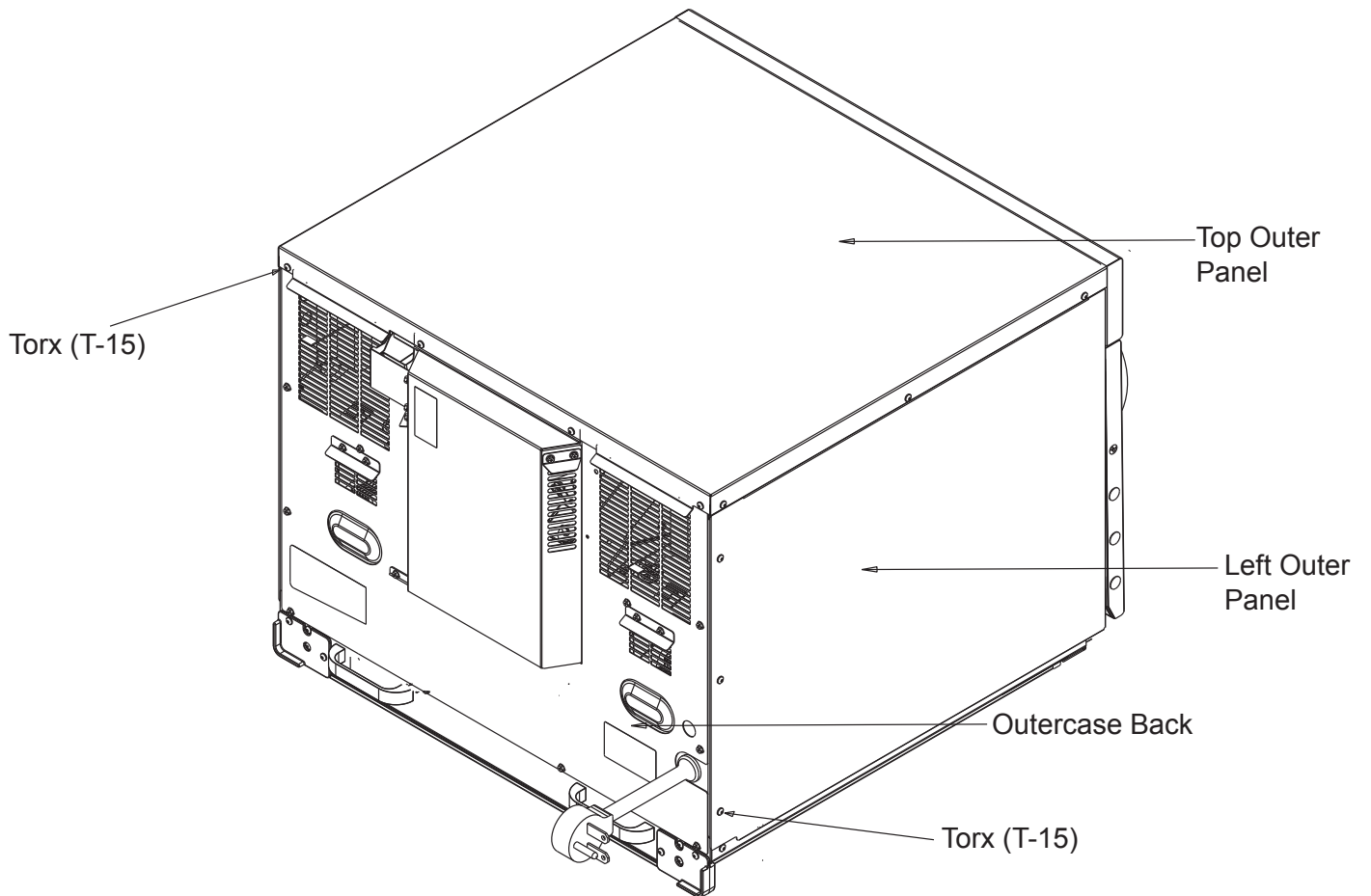
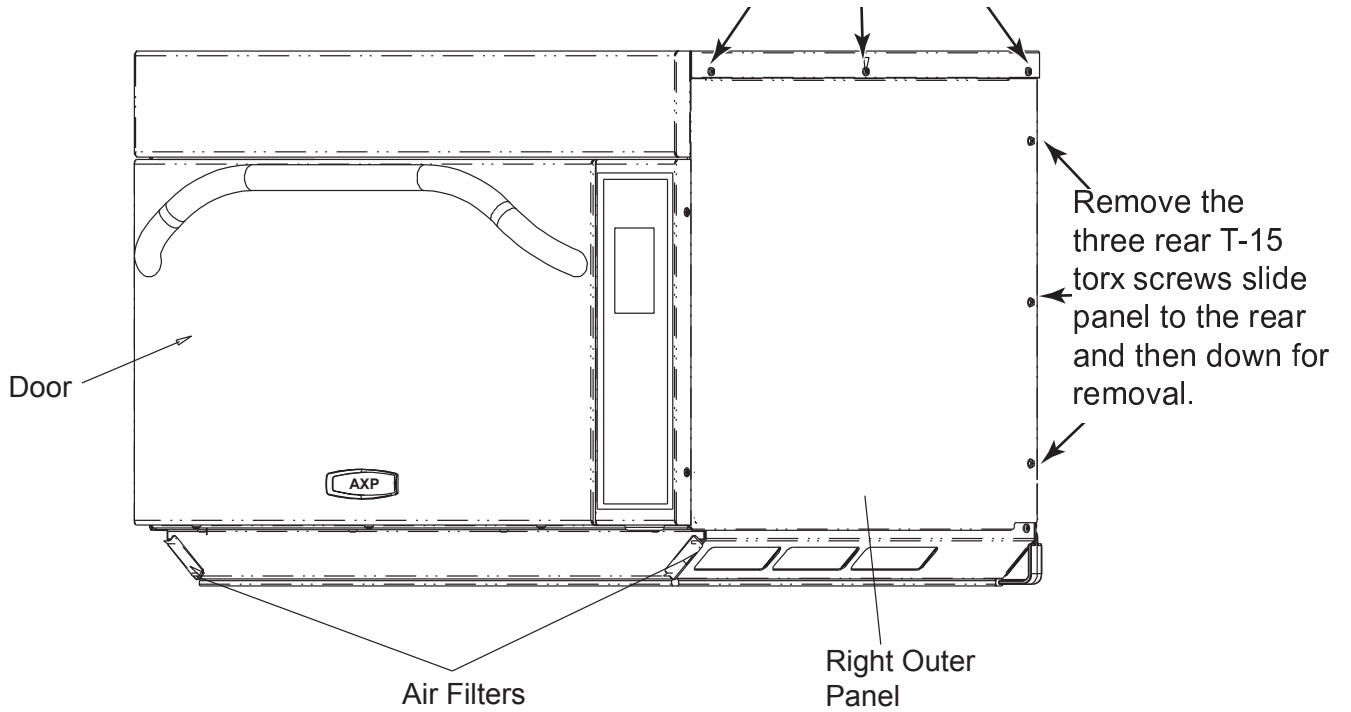

# Door Construction

## Door Assembly

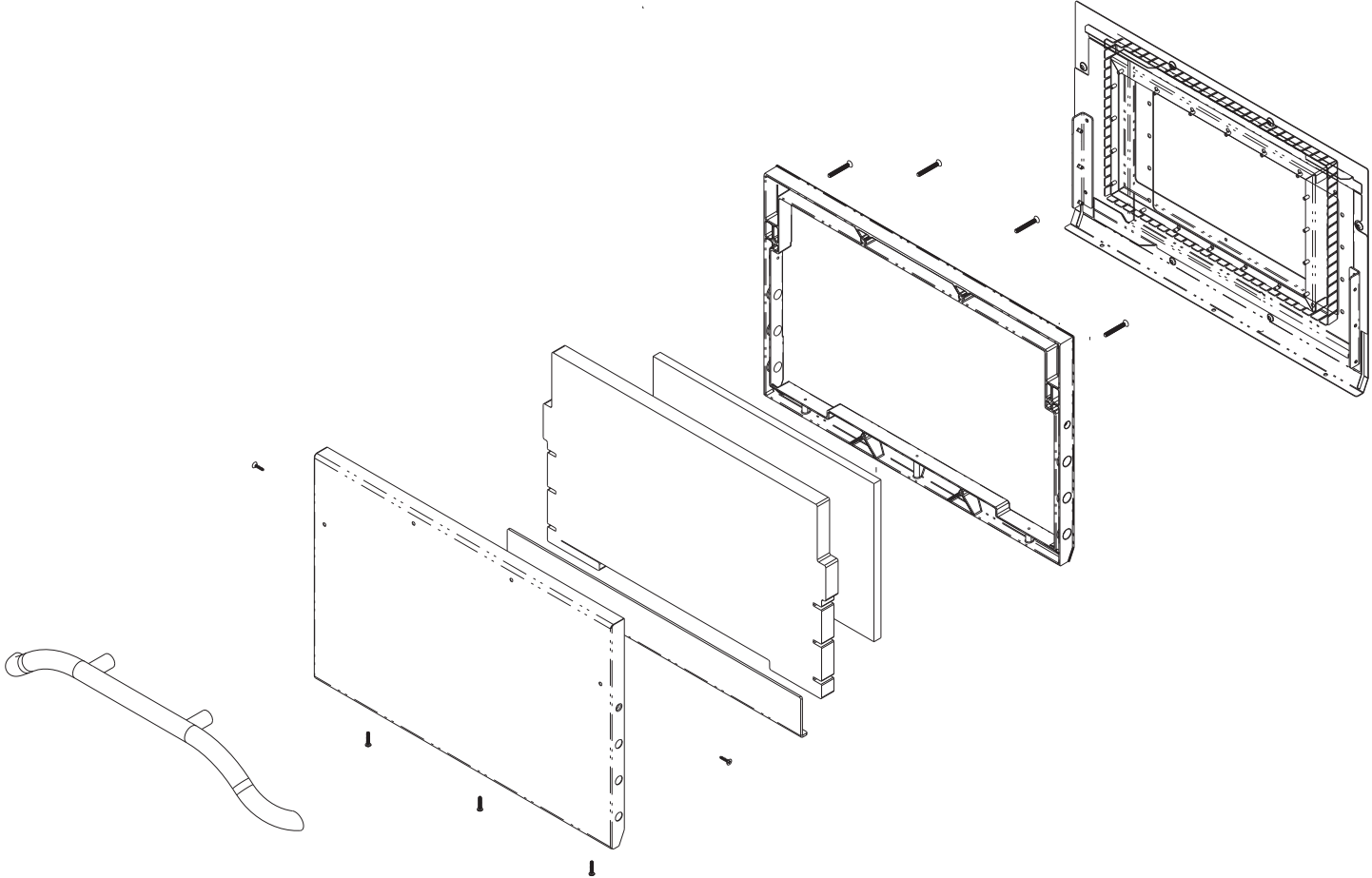

# Oven Construction

HV Transformers  
Magnetrons  
Fuses  
Sensor  
Triac's  
Magnetron TCO's  
Capacitor / Diodes

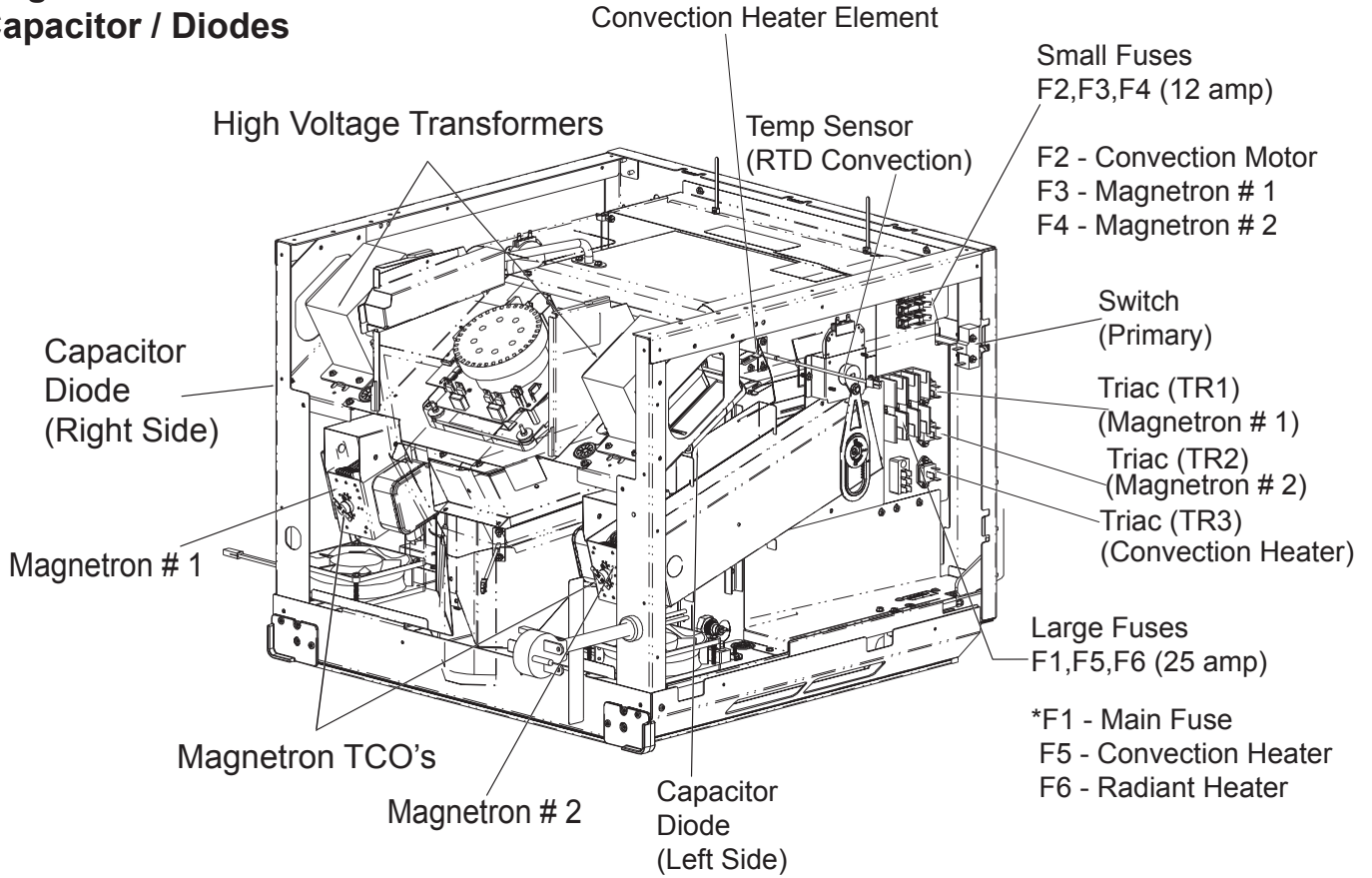

**\*Note: If Main Fuse (F1) is blown  
replace Relay Monitor  
Board and Power Relay.**

# Oven Construction

- Circuit Boards
- Power Relay
- Limiter
- Triac
- Thermocouple (RTD)
- Temp Sensor (RTD)
- Cooling Fans
- Convection Motor

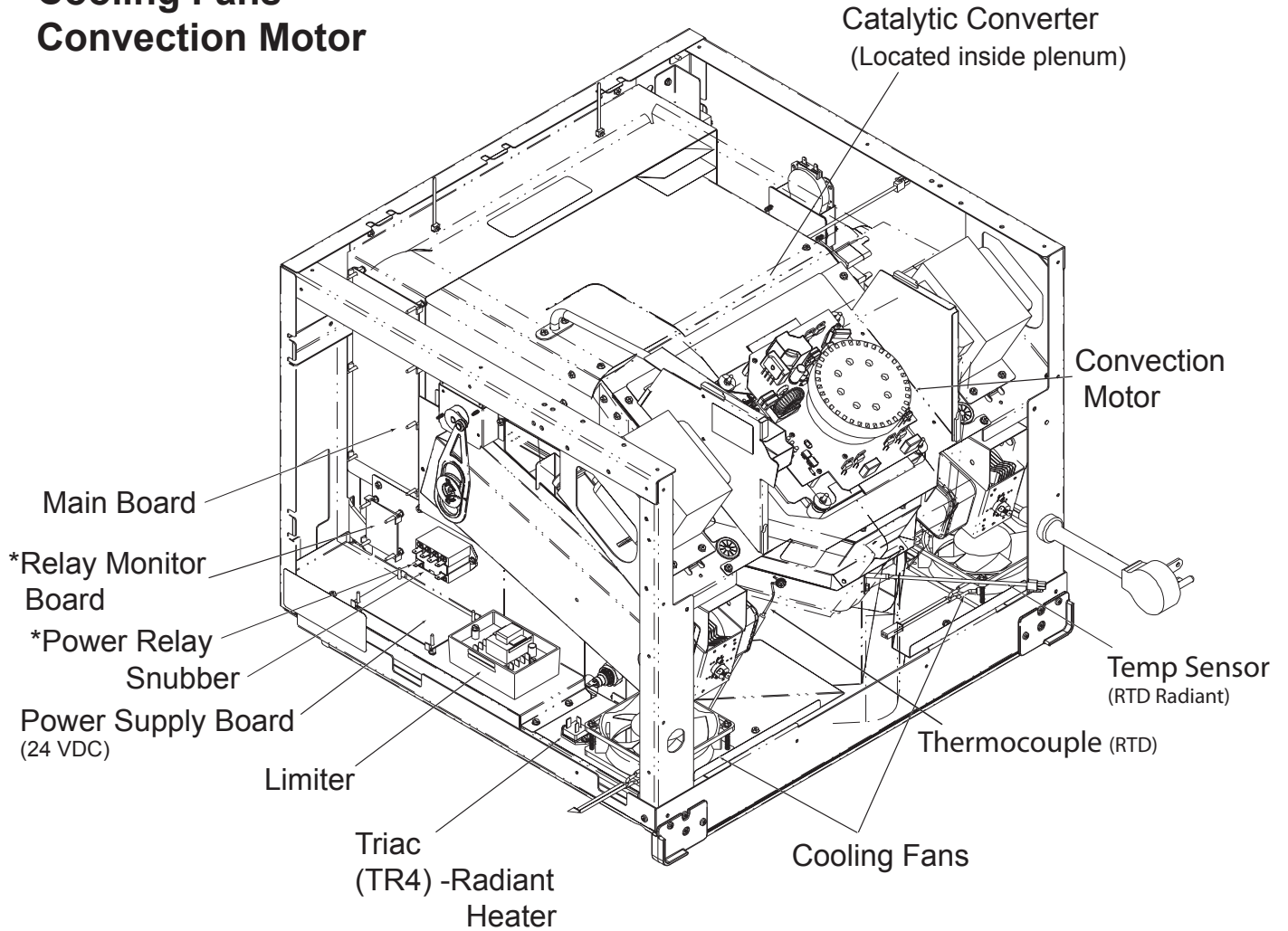

**\*Note: If Main Fuse (F1) is blown  
replace Relay Monitor Board  
and Power Relay.**

# Oven Construction

## AXP20 / MXP20 CONTROL PANEL ASSEMBLY

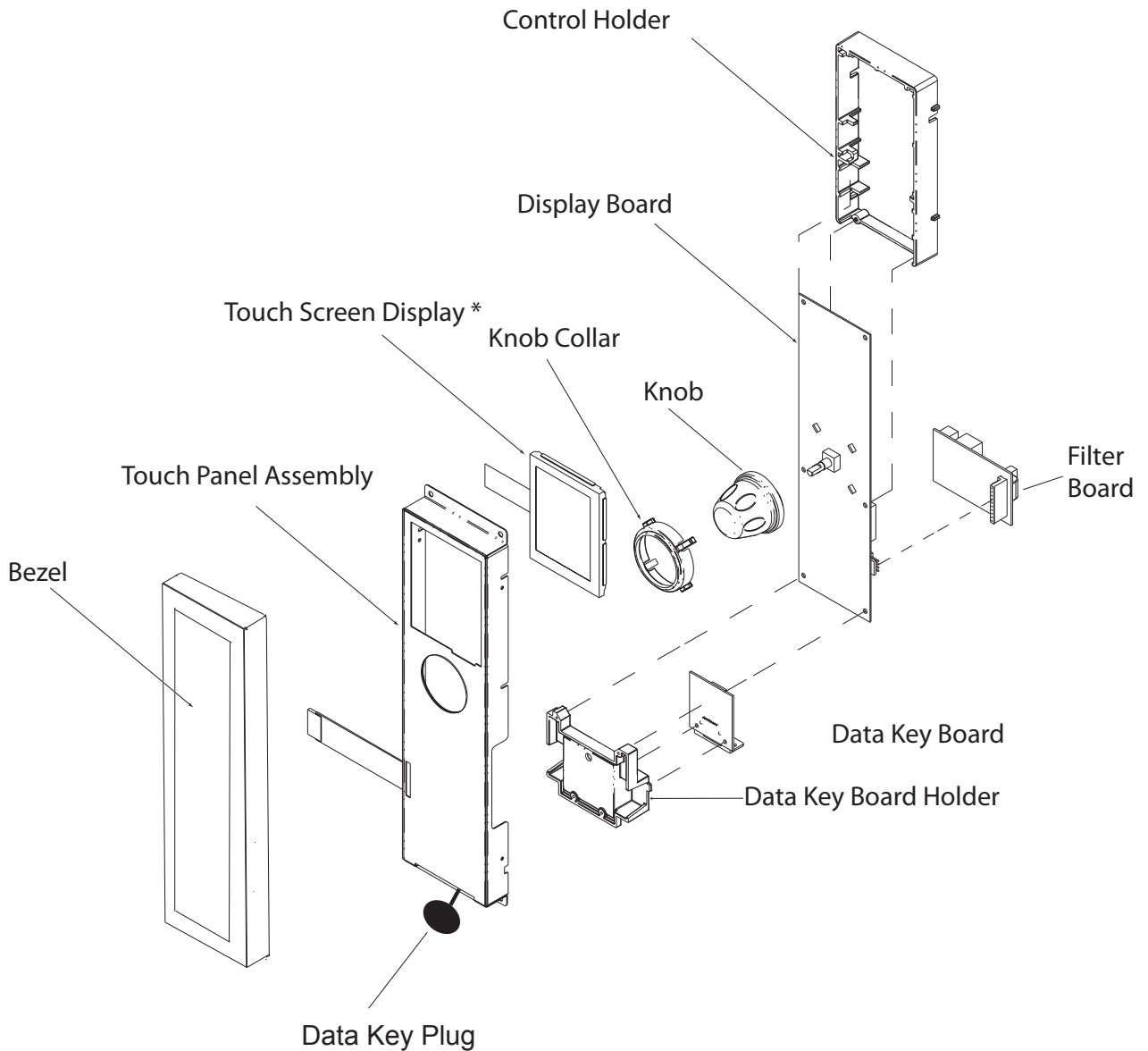

**\* Caution:** Do not handle touch screen display by the sides. This may damage the display circuitry. Handle using the corners.

# Oven Construction

## AXP22 / MXP22 CONTROL PANEL ASSEMBLY

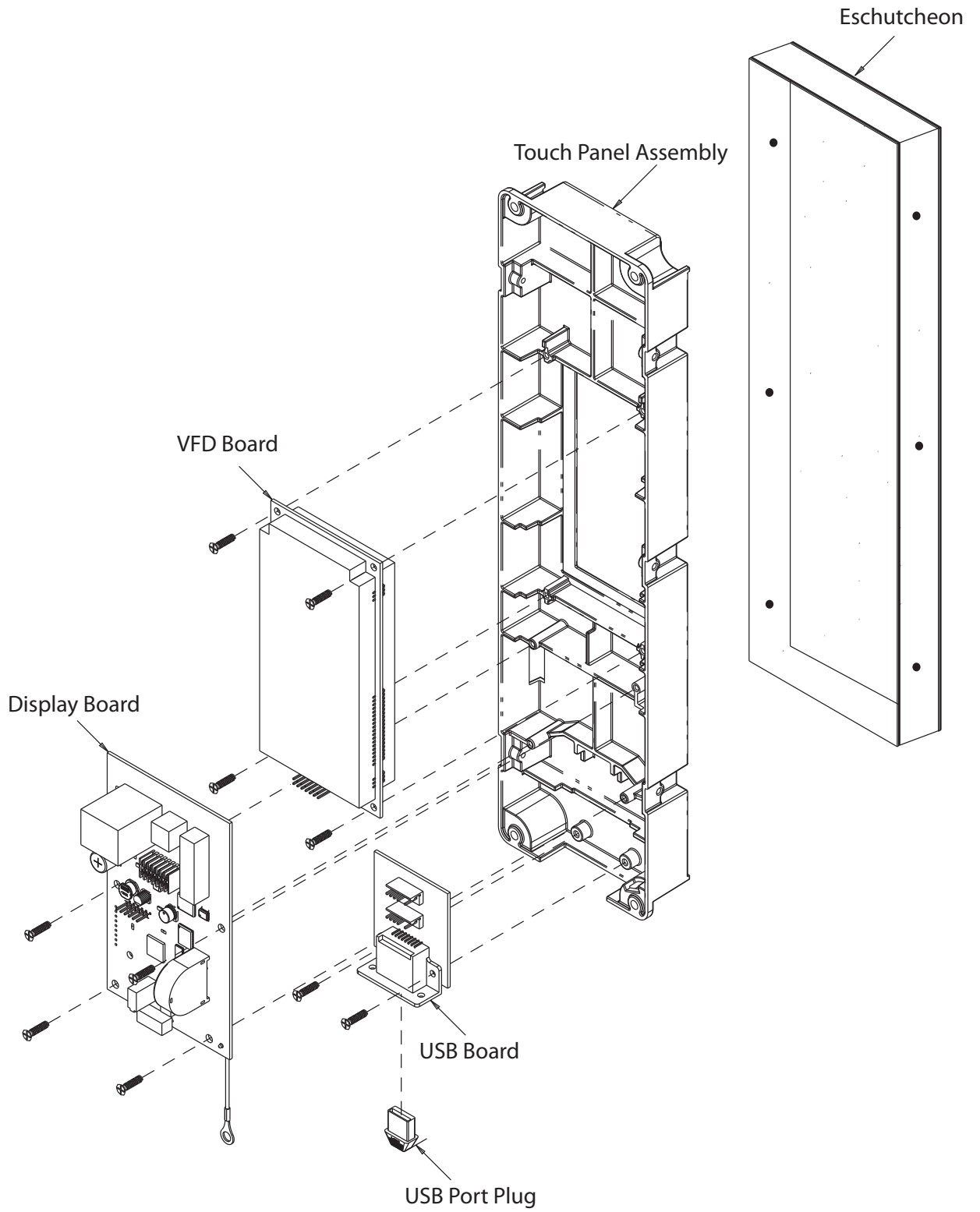

# Oven Construction

- Antenna Motor
- Cam
- Gear Assembly
- Antenna
- Rivet, Plastic
- Radiant Heater

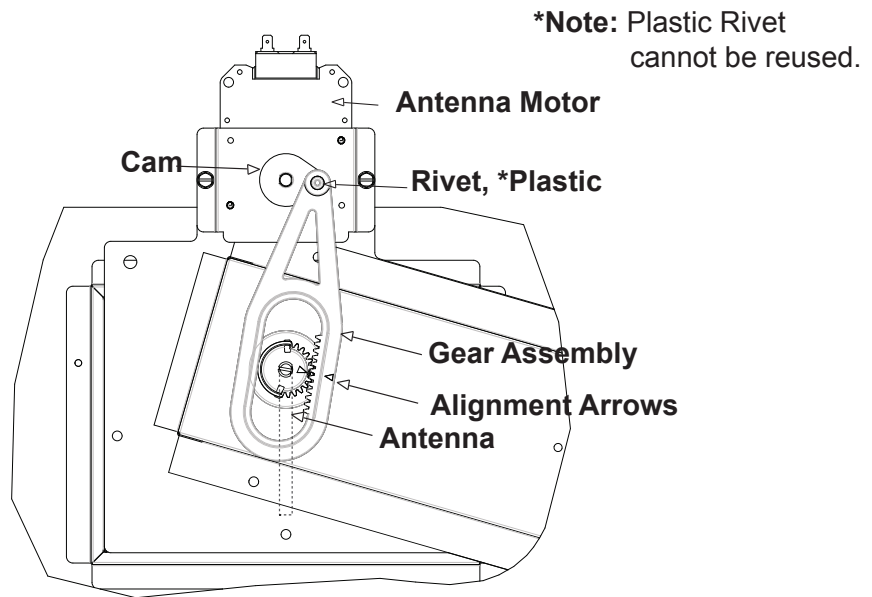
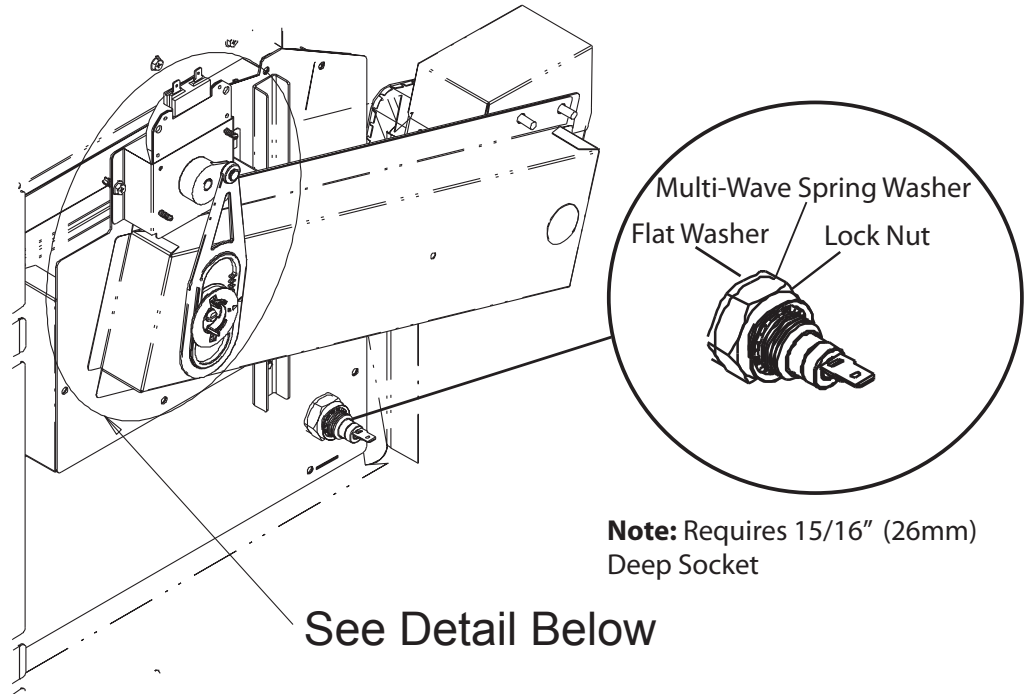

## Oven Construction

### AXP22 / MXP22 Ceramic Tray

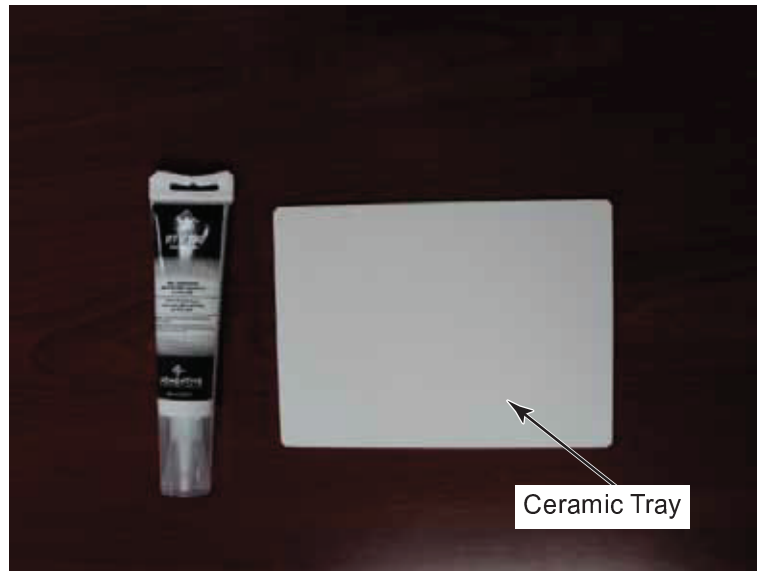

- **Ceramic trays** can be replaced without replacing waveguide. Ceramic trays for both waveguides are available as a separate kit which includes (1) ceramic tray and a tube of high temperature sealer with installation instructions.

### AXP22 / MXP22 Replaceable Waveguide

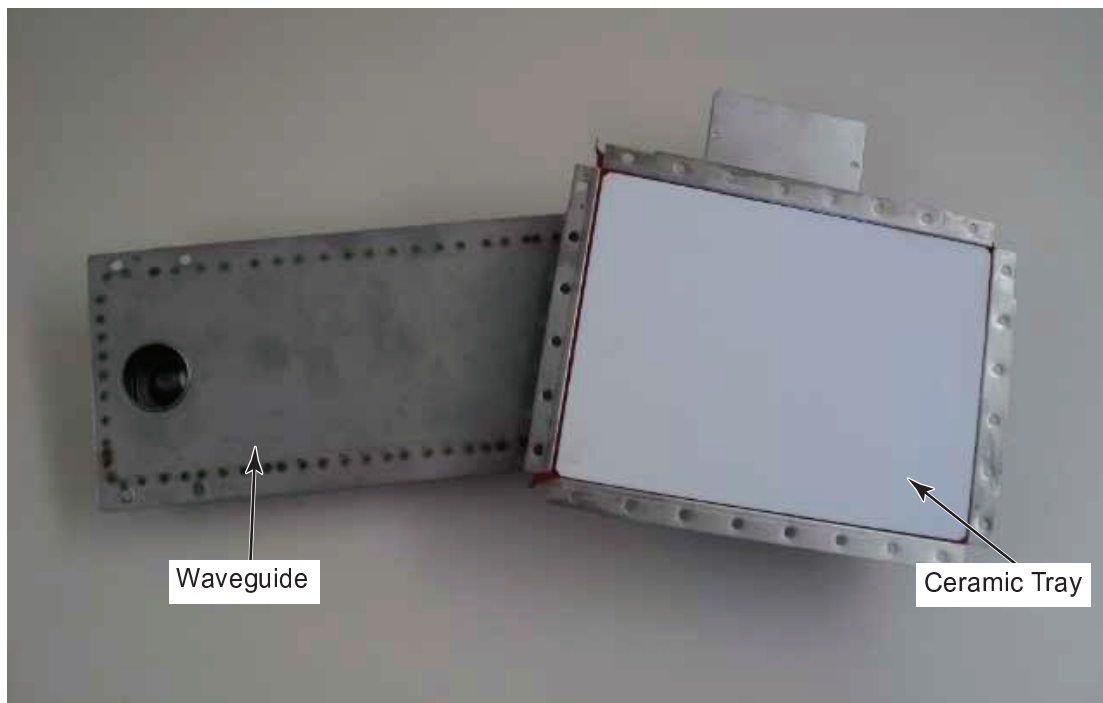

- **Waveguides** are replaceable on AXP22\* / MXP22\* models. Waveguides are available as a right hand or left hand waveguide kit which includes new mounting nuts, studs, antenna, and ceramic tray installed in waveguide with installation instructions.

# **5 | AXP20 / MXP20, AXP22 / MXP22 60 Hz Interlock Switch Service**

# Interlock Switch Service

## Oven Switch Replacement & Interlock Switch Adjustment

Attach Ohm-Meter to  
Wire Harness Connectors

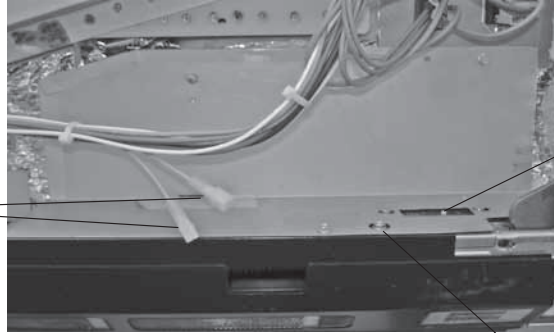

Switch Adjustment  
Lever

## Adjustment

Figure 1

Mounting Screw

### Switch Test:

When the door is opened or closed, the left door hinge activates the secondary / monitor switches.

1. Connect an ohm-meter to wire harness (as shown in figure 1, to verify switch activation).

**Note:** The switch assembly should activate when the door gap is approximately 1/4 inch (6mm).

### Switch Adjustment:

1. Loosen mounting screws.
2. Slide adjustment lever for proper switch activation.
3. Tighten mounting screws.
4. Preheat oven to set temperature and verify switch adjustment settings and function.

**Note:** To ensure proper switch adjustment, the switch mounting **MUST** be tightened after each adjustment prior to testing the door alignment.

## Replacement

### Removal:

1. Remove switch assembly mounting screw.
2. Push switch assembly 1/2 inch (13mm) towards back of oven.
3. Twist mounting leg towards oven cavity to release mounting tab.
4. Push assembly towards back of oven to remove.

**Note:** New replacement switch assembly has been adjusted at the factory, no adjustment should be necessary.

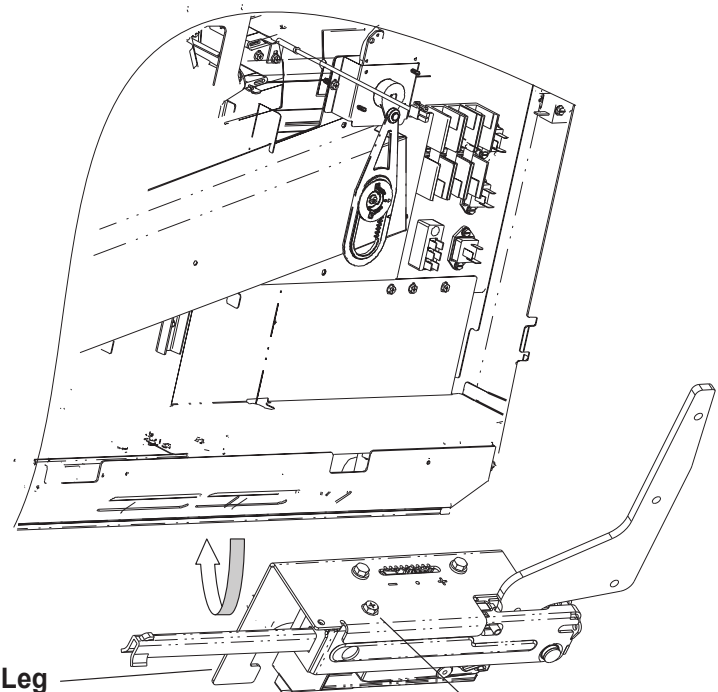

Mounting Leg

Mounting Screw

# **6 | AXP20 / MXP20, AXP22 / MXP22 60 Hz Oven Performance Test**

# Oven Performance Test AXP20 / MXP20

**Note:** To run Oven Performance Test the, OVEN CAVITY MUST BE AT ROOM TEMPERATURE, and the display must read MICROWAVE ONLY mode. See below using oven as a microwave oven. If MICROWAVE ONLY is not in display you must go to User Options and activate MICROWAVE ONLY option.

## Changing User Options:

1. Oven must be OFF.
2. Press and hold Pad "2" for 5 seconds.

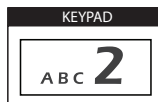

3. Rotate dial to highlight: ALLOW MICROWAVE ONLY mode.
4. Press SAVE.

## USING OVEN AS A MICROWAVE OVEN

This option is only available if the oven cavity temperature is less than 200°F.

When user option MICROWAVE ONLY is set as a default, the MICROWAVE ONLY button appears on the PREHEAT MENU.

See page 11 for Oven Performance Test procedure.

To run Performance Test using microwave only follow these steps:

1. Place filled (1000 ml) test bowl in oven.
2. Press MICROWAVE ONLY button.



3. Press manual cook.
4. Press Pad 3 twice for 33 seconds.
5. Press Start.
6. Oven will beep, remove test bowl from oven.
7. Press OFF to return to PREHEAT MENU.

## PREHEAT MENU

PREHEAT TEMP = 475° F

PRESS TO  
PREHEAT

MICROWAVE ONLY









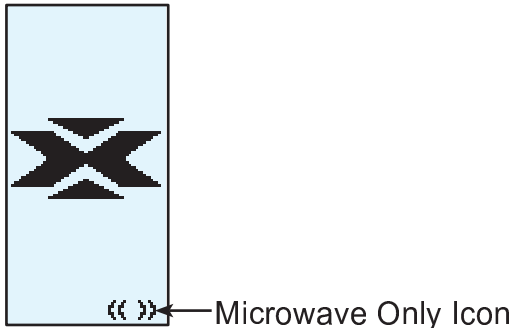

PROGRAM

CHANGE  
TEMP

# Oven Performance Test AXP22 / MXP22







**Note:** To run Oven Performance Test the, OVEN CAVITY MUST BE AT ROOM TEMPERATURE, and the display must read MICROWAVE ONLY mode. See below using oven as a microwave oven. If MICROWAVE ONLY icon does not appear in the bottom right corner of the display you must go to User Options and activate MICROWAVE ONLY option #15.



1. Oven must be off. To turn oven off, press ON/OFF  keypad.
2. Press  again til  appears in display
2. Press and hold “2” keypad until option screen appears.
3. Choose option by pressing Enter  keypad then use Scroll Up  and Scroll Down  keypad to select option #15. Scroll Up  and Scroll Down  keypad to highlight Microwave Only Icon. 
4. Press Start  keypad to save and press Stop / Reset  to exit options mode.
5. Option 6, if password needed is highlighted press Program keypad to view or edit password.

See page 38 for Oven Performance Test procedure.

To run Performance Test using microwave only follow these steps:

1. Press manual cook. 
2. Press forward  arrow icon. 1 thru 0 will appear in the display.
3. Press manual cook. 
4. Press Pad 3 twice for 33 seconds.
5. Place filled (1000 ml) test bowl in oven.
6. Press Start  keypad.
7. Oven will beep, remove test bowl from oven.
8. After test is complete return to options and reset option #15 from  to .

# Oven Performance Test

All Amana and Menumaster microwave oven power outputs are rated using the IEC705 standards. Using the IEC705 test method requires precision measurements and equipment that is not practical to be performed in the field. Using the test shown below will indicate if the oven performance is satisfactory.

## Test equipment required:

- 1000 ml test container and thermometer (ACP Power Test Bowl part # [12018801](#)).
- Digital watch / watch with a second hand for use on ovens with electromechanical timers.

## Important Notes:

- Low line voltage will cause low temperature rise / power output.
- Ovens must be on a dedicated circuit, properly grounded, and polarized. Other equipment on the same circuit may cause a low temperature rise / power output.
- This test and results are not a true IEC705 test procedures and are only intended to provide servicers with an easy means of determining if the microwave oven cooking output is correct.

## Procedure

1. Fill the test container to the 1000 ml line with cool tap water.

**NOTE:** Water temperature should be approximately 60°F / 16°C

2. Using the thermometer, stir water for five to ten seconds; measure, and record the temperature (T1).
3. Place test container of water in the center of oven cavity and close door.
4. Heat the water for a 33-second full power cycle.

**NOTE:** Use a digital watch or a watch with a second hand for ovens with electromechanical timers.

5. At end of the cycle, remove test container. Using the thermometer, stir water for five to ten seconds and record temperature (T2).
6. Subtract the starting water temperature (T1), from the ending water temperature (T2) to obtain the temperature rise ( $\Delta T$ ).
7. If the temperature rise ( $\Delta T$ ) meets or exceeds the minimum, the test is complete. If the temperature rise ( $\Delta T$ ) fails to meet the minimum temperature rise, test the line voltage to verify it is correct. Then repeat steps 1-6 making sure to change the water. If the temperature rise ( $\Delta T$ ) fails to meet the minimum temperature rise again the oven will require service.

**Minimum Temperature Rise at Thirty -Three (33) Seconds Run Time**



$\Delta T$ (°F)	Cooking Power Output	$\Delta T$ (°F)	Cooking Power Output	$\Delta T$ (°C)	Cooking Power Output	$\Delta T$ (°C)	Cooking Power Output
10.....	1000	20 .....	2000	5 .....	1000	11 .....	2000
11.....	1100	21 .....	2100	5.5.....	1100	11.5.....	2100
12.....	1200	22 .....	2200	6.5.....	1200	12 .....	2200
14.....	1400	24 .....	2400	7.5.....	1400	13 .....	2400
17.....	1700	25 .....	2500	9.5.....	1700	13.5.....	2500
18.....	1800	27 .....	2700	10 .....	1800	15 .....	2700
19.....	1900	30 .....	3000	10.5.....	1900	16.5.....	3000

# **7** | **AXP20 / MXP20, AXP22 / MXP22** **60 Hz Component Testing** **Procedures**

# Component Testing Procedures

## ⚠ WARNING

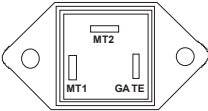
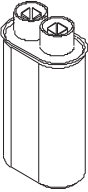
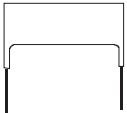
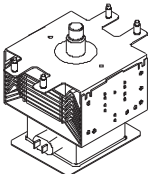
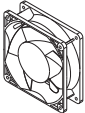
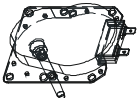
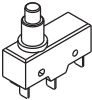

To avoid risk of electrical shock, personal injury or death; disconnect power to oven and discharge capacitor before servicing, unless testing requires power.

Illustration	Component	Test	Results
	Thermal cutout	Disconnect all wires from TCO. Measure resistance across terminals. Control TCO ..... Magnetron TCO .....	Closed at 235°F (113°C) and open at 150°F (66°C) Open at 300°F (149°C) and closed at 257°F (125°C)
	Diode	<b>Discharge Capacitor</b>  Remove diode lead from capacitor and connect ohmmeter.  Reverse leads for second test.	Infinite resistance should be measured in one direction and 50KΩ or more in the opposite direction.  <b>NOTE:</b> Ohmmeter must contain a battery of 6 volts minimum.
	Triac	Disconnect wires to triac.  Measure resistance from: MT1 to MT2 ..... MT1 to Gate .....  MT2 to Gate ..... All terminals to ground .....	<b>Caution - Do not operate oven with wire to terminal MT2 removed.</b>  Infinite Approximately 15 Ω, then reverse meter leads 30 Ω Infinite Infinite
Triac 1 (top) is for front element Triac 2 (middle) is for rear element		Measure voltage from: MT1 to Gate	0.8 VAC when energized. If no voltage, check H.V. board and wiring.
	Capacitor	<b>Discharge Capacitor</b>  Remove wires from capacitor terminals and connect ohmmeter, set on highest resistance scale to terminals.  Also check between each terminal and capacitor case.....	Between Terminals: Meter should momentarily deflect towards zero then return to over 5 MΩ. If no deflection occurs, or if continuous deflection occurs, replace capacitor.  Terminal to Case: Infinite resistance
	Snubber assembly	Disconnect wires to snubber.  Measure resistance across terminals.....	Infinite
	Magnetron	<b>Discharge Capacitor</b>  Remove wires from magnetron and connect ohmmeter to terminals. Also check between each terminal and ground.	Between Terminals: Less than 1 Ω  Each terminal to ground measures Infinite resistance. <b>Note:</b> This test is not conclusive. If oven does not heat and all other components test good replace the magnetron and retest.
	Cooling blower motor	Measure voltage at motor	Approximately 24 vdc at incoming leads
	Stirrer motor	Remove all wires from terminals.  Measure resistance from: Terminal to terminal.....	Approximately 29K Ω
	Interlock, primary	Remove violet and orange from terminals. Measure resistance from: NO to Common (Door Open)..... NO to Common (Door Closed).....	Infinite Continuity

# Component Testing Procedures

## ⚠ WARNING

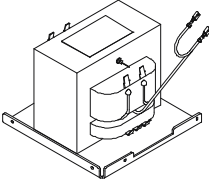
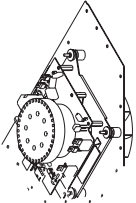
To avoid risk of electrical shock, personal injury or death; disconnect power to oven and discharge capacitor before servicing, unless testing requires power.

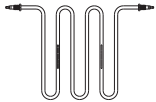
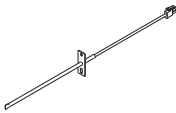
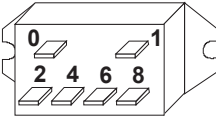
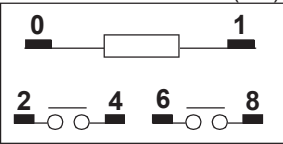
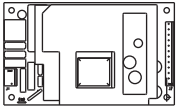
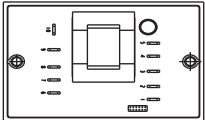
Illustration	Component	Test	Results
	Transformer	<p><b>Discharge Capacitor</b> Remove all wires from terminals.</p> <p>Measure resistance from:                      230 to COM.....                      208 to COM.....                      230 to Ground.....                      208 to Ground.....                      Terminal 5 to 6.....                      Terminal 4 to Ground.....</p>	<p>Less than 1 Ω                      Less than 1 Ω                      Infinite                      Infinite                      Less than 1 Ω                      Approximately 46 Ω</p>
	Convection blower motor	Perform service test on low and high speed to verify operation. Service test procedure is located in Service Test section.	
	Convection heating element	<p>Disconnect wires from terminals.</p> <p>Measure resistance across heating element.                      Element                    2000 W .....</p>	Approximately 19 - 22 Ω
	Cavity heating element	<p>Disconnect wires from terminals.</p> <p>Measure resistance across heating element.                      Element                    3000 W .....</p>	Approximately 14 Ω
	Thermocouple (RTD) (Convection Heater) Temp Sensor (Cavity Heater) Temp Sensor	<p>Temperature</p> <p>32°F .....</p> <p>350°F .....</p>	<p>Resistance</p> <p>1000 Ω</p> <p>1654 Ω</p>
	Relay  This relay contains a diode in the coil circuit.	<p>Measure resistance from:                      Terminal 0 to terminal 1 (coil) .....</p> 	<p>Approximately 6 to 7 M Ω</p> <p>Terminal 0 - 1 Line Voltage</p> <p>Terminal 2 - 6 Line Voltage</p> <p>Terminal 4 - 8 Line Voltage</p> <p><b>NOTE:</b> Analog meter is recommended for measurement.</p> <p><b>NOTE:</b> If using a digital meter it must contain a battery of 6 volts minimum.</p>
Wire harness	High voltage board to display module harness	Test continuity of wires .....	Indicates continuity
	Power supply board 24 Volt	<p>Input voltage Orange J1-1 to Red J1-3.....</p> <p>Red J2-1 to White J2-6 Power Supply Board</p>	<p>Line Voltage</p> <p>Approximately 24 vdc</p>
	Limiter, Electronic	<p>Orange 9 to Red 10.....</p> <p>Yellow 6 to Yellow 7 .....</p>	<p>Line Voltage</p> <p>Approximately 24 vdc</p>

# 8 | **AXP20 / MXP20 60 Hz Service Test**

# Service Test AXP20 / MXP20

## Access to Service Mode

Screen



Hidden Pad

While at the Main Screen, press the following sequence on the keypad:

**NOTE:** The “MICROWAVE ONLY” button may or may not be present.

1. Press OFF pad until PRESS TO PREHEAT appears.
  2. Press Hidden Pad.
  3. Press pads 1 - 3 - 5 - 7 - 9
- The display indicates SERVICE MODE.

## Oven Information

1

Screen

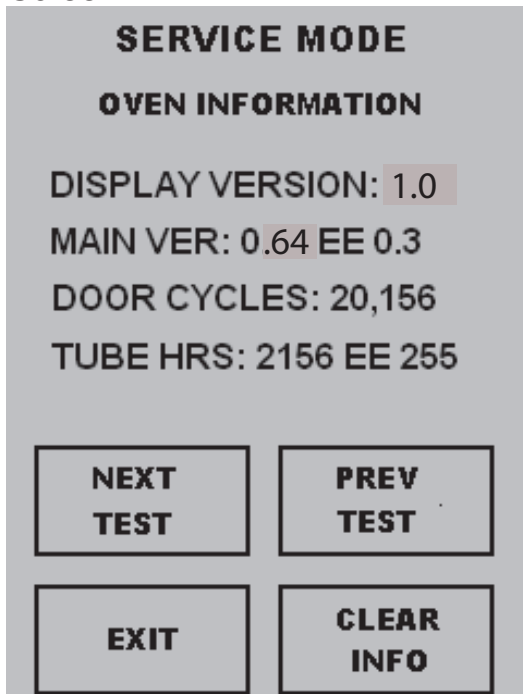

This screen is Oven Information showing the versions of software in the control boards and information about door cycles and tube hours.

**NEXT TEST:** Press this pad to go to the next Service Mode Test

**PREV TEST:** Press this pad to go to the previous Service Mode Test

**CLEAR INFO:** Press this pad to reset the Door Cycles and Tube Hours back to zero.

**EXIT:** Press this pad to return to the ovens Main Menu

# Service Test AXP20 / MXP20

Manual Operation of Magnetrons #1 & #2	2
<p>Screen</p> <p><b>SERVICE MODE</b></p> <p><b>MAGNETRONS #1 &amp; #2</b></p> <p>MAGNETRON #1: 9 AMPS</p> <p>MAGNETRON #2: 9 AMPS</p> <p>ACCEPTABLE RANGE:</p> <p><b>NEXT TEST</b>      <b>PREV TEST</b></p> <p><b>CANCEL</b>          <b>TURN ON</b></p>	<p>This screen will allow operation of Magnetron #1 and #2 together and show the number of amps being drawn.</p> <p><b>NEXT TEST:</b> Press this pad to go to the next Service Mode Test</p> <p><b>PREV TEST:</b> Press this pad to go to the previous Service Mode Test</p> <p><b>TURN ON:</b> This pad will toggle between turning the magnetrons on and off.</p> <p><b>CANCEL:</b> Press this pad to return to the Main Menu</p> <p><b>RANGE:</b> Under normal operation, each mag's amp draw should be <b>5 – 12 amps</b>.</p>

Manual Operation of Magnetron #1	3
<p>Screen</p> <p><b>SERVICE MODE</b></p> <p><b>MAGNETRON #1</b></p> <p>CURRENT DRAW: 9 AMPS</p> <p>ACCEPTABLE RANGE:</p> <p><b>NEXT TEST</b>      <b>PREV TEST</b></p> <p><b>CANCEL</b>          <b>TURN ON</b></p>	<p>This screen will allow operation of Magnetron #1 and show the number of amps being drawn.</p> <p><b>NEXT TEST:</b> Press this pad to go to the next Service Mode Test</p> <p><b>PREV TEST:</b> Press this pad to go to the previous Service Mode Test</p> <p><b>TURN ON:</b> This pad will toggle between turning the magnetron on and off.</p> <p><b>CANCEL:</b> Press this pad to return to the Main Menu</p> <p><b>RANGE:</b> Under normal operation, the amp draw should be <b>5 – 12 amps</b>.</p>

# Service Test AXP20 / MXP20

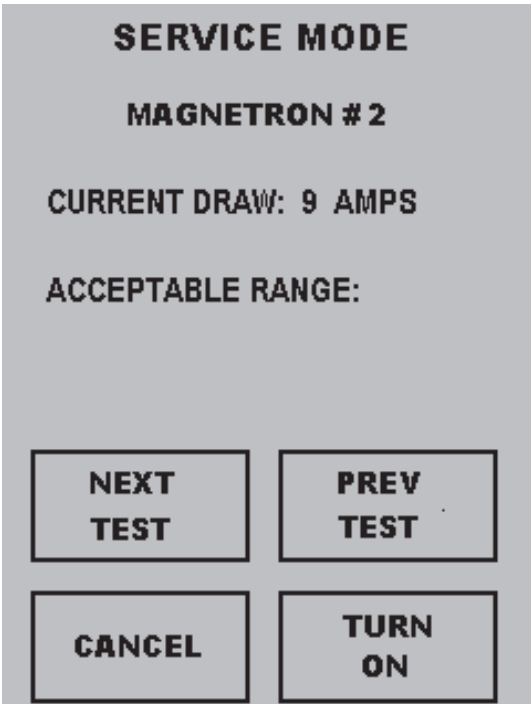
Manual Operation of Magnetron #2		4
Screen		<p>This screen will allow operation of Magnetron #2 and show the number of amps being drawn.</p> <p><b>NEXT TEST:</b> Press this pad to go to the next Service Mode Test</p> <p><b>PREV TEST:</b> Press this pad to go to the previous Service Mode Test</p> <p><b>TURN ON:</b> This pad will toggle between turning the magnetron on and off.</p> <p><b>CANCEL:</b> Press this pad to return to the Main Menu</p> <p><b>RANGE:</b> Under normal operation, the amp draw should be <b>5 – 12 amps</b>.</p>

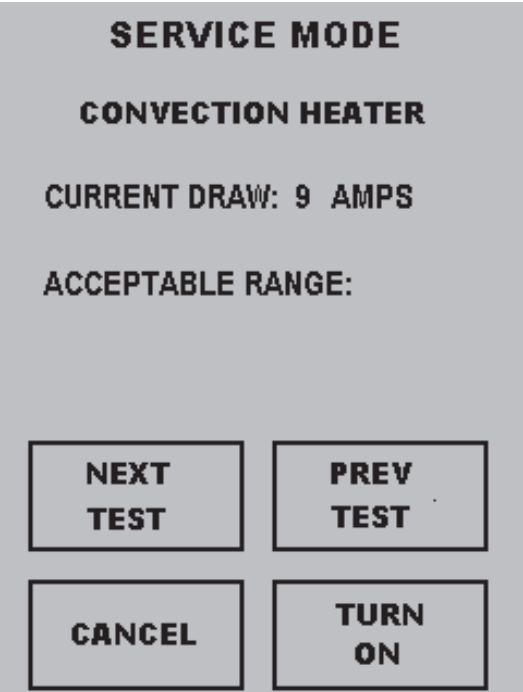
Convection Heater		5
Screen		<p>This screen will allow operation of the convection heater and show the number of amps being drawn.</p> <p><b>NEXT TEST:</b> Press this pad to go to the next Service Mode Test</p> <p><b>PREV TEST:</b> Press this pad to go to the previous Service Mode Test</p> <p><b>TURN ON:</b> This pad will toggle between turning the heater on and off.</p> <p><b>CANCEL:</b> Press this pad to return to the Main Menu</p> <p><b>RANGE:</b> Under normal operation, the amp draw should be <b>5 – 12 amps</b>.</p>

# Service Test AXP20 / MXP20

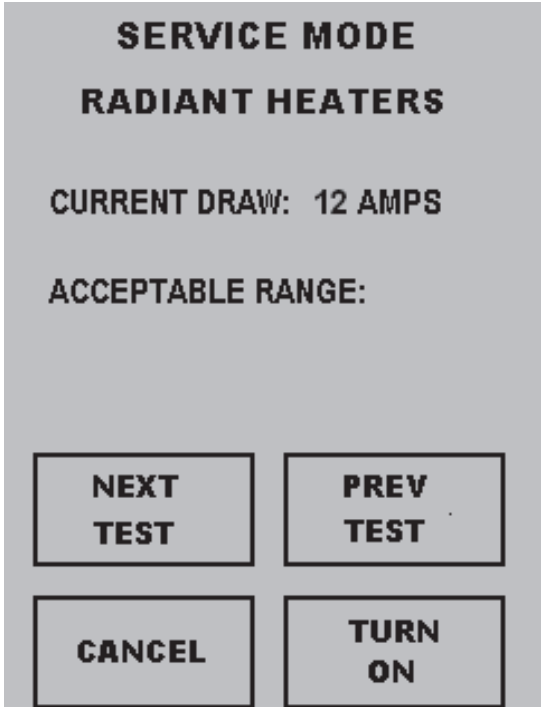
Radiant Heater	6
<p>Screen</p>  <p><b>SERVICE MODE</b> <b>RADIANT HEATERS</b></p> <p>CURRENT DRAW: 12 AMPS</p> <p>ACCEPTABLE RANGE:</p> <p><b>NEXT TEST</b>      <b>PREV TEST</b></p> <p><b>CANCEL</b>          <b>TURN ON</b></p>	<p>This screen will allow operation of the radiant heater and show the number of amps being drawn.</p> <p><b>NEXT TEST:</b> Press this pad to go to the next Service Mode Test</p> <p><b>PREV TEST:</b> Press this pad to go to the previous Service Mode Test</p> <p><b>TURN ON:</b> This pad will toggle between turning the heater on and off.</p> <p><b>CANCEL:</b> Press this pad to return to the Main Menu</p> <p><b>RANGE:</b> Under normal operation, the amp draw should be <b>10 – 16 amps</b>.</p>

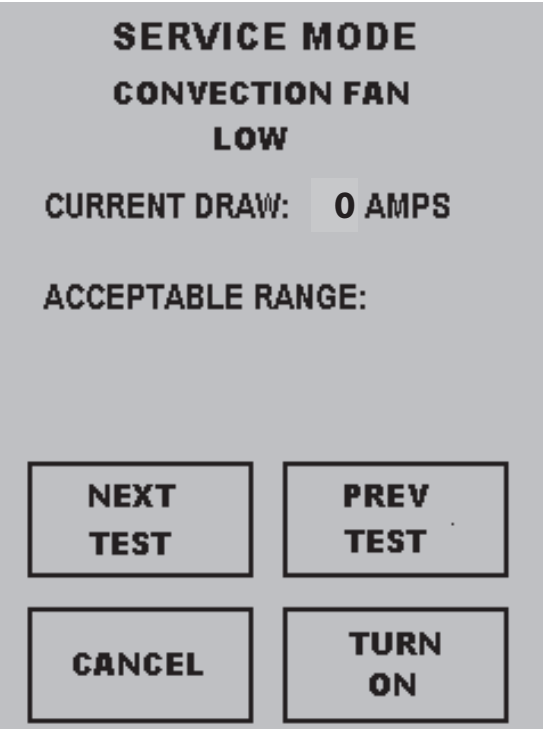
Convection Fan – Low Speed	7
<p>Screen</p>  <p><b>SERVICE MODE</b> <b>CONVECTION FAN</b> <b>LOW</b></p> <p>CURRENT DRAW: 0 AMPS</p> <p>ACCEPTABLE RANGE:</p> <p><b>NEXT TEST</b>      <b>PREV TEST</b></p> <p><b>CANCEL</b>          <b>TURN ON</b></p>	<p>This screen will allow operation of the convection fan at a low speed and show the number of amps being drawn.</p> <p><b>NEXT TEST:</b> Press this pad to go to the next Service Mode Test</p> <p><b>PREV TEST:</b> Press this pad to go to the previous Service Mode Test</p> <p><b>TURN ON:</b> This pad will toggle between turning the convection fan on and off at a low speed.</p> <p><b>CANCEL:</b> Press this pad to return to the Main Menu</p> <p><b>RANGE:</b> Under normal operation, the amp draw is too low to read.</p>

# Service Test AXP20 / MXP20

## Convection Fan – High Speed

8

Screen

**SERVICE MODE**  
**CONVECTION FAN**  
**HIGH**

CURRENT DRAW: 1.5 AMPS

ACCEPTABLE RANGE:

**NEXT TEST**      **PREV TEST**

**CANCEL**          **TURN ON**

This screen will allow operation of the convection fan at a high speed and show the number of amps being drawn.

**NEXT TEST:** Press this pad to go to the next Service Mode Test

**PREV TEST:** Press this pad to go to the previous Service Mode Test

**TURN ON:** This pad will toggle between turning the convection fan on and off at a high speed.

**CANCEL:** Press this pad to return to the Main Menu

**RANGE:** Under normal operation, the amp draw should be **0.6 – 2.6 amps.**  
(It may not read amps)

## Cooling Fan

9

Screen

**SERVICE MODE**  
**COOLING FAN**

CURRENT DRAW: 1.5 AMPS

ACCEPTABLE RANGE:

**NEXT TEST**      **PREV TEST**

**CANCEL**          **TURN ON**

This screen will allow operation of the cooling fan show the number of amps being drawn.

**NEXT TEST:** Press this pad to go to the next Service Mode Test

**PREV TEST:** Press this pad to go to the previous Service Mode Test

**TURN ON:** This pad will toggle between turning the cooling fan on and off.

**CANCEL:** Press this pad to return to the Main Menu

**RANGE:** Under normal operation, the amp draw should be **0.9 – 2.5 amps.**  
(It may not read amps)

# Service Test AXP20 / MXP20

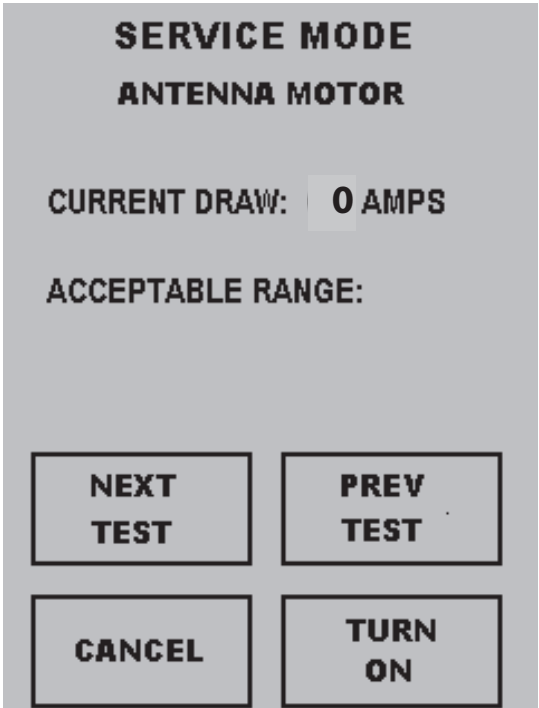
Antenna Motor	10
<p>Screen</p>  <p><b>SERVICE MODE</b> <b>ANTENNA MOTOR</b></p> <p>CURRENT DRAW: 0 AMPS</p> <p>ACCEPTABLE RANGE:</p> <p><b>NEXT TEST</b>      <b>PREV TEST</b></p> <p><b>CANCEL</b>          <b>TURN ON</b></p>	<p>This screen will allow operation of the antenna motor show the number of amps being drawn.</p> <p><b>NEXT TEST:</b> Press this pad to go to the next Service Mode Test</p> <p><b>PREV TEST:</b> Press this pad to go to the previous Service Mode Test</p> <p><b>TURN ON:</b> This pad will toggle between turning the antenna motor on and off.</p> <p><b>CANCEL:</b> Press this pad to return to the Main Menu</p> <p><b>RANGE:</b> Under normal operation, the amp draw may be to low to read.</p>

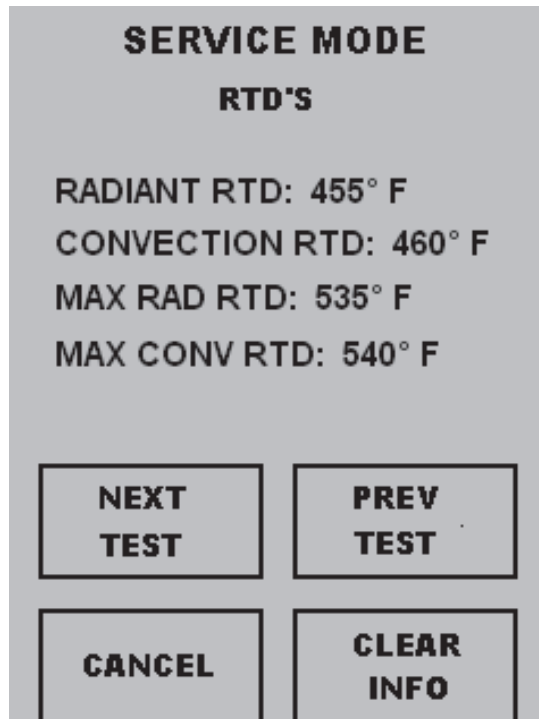
RTD Status	11
<p>Screen</p>  <p><b>SERVICE MODE</b> <b>RTD'S</b></p> <p>RADIANT RTD: 455° F CONVECTION RTD: 460° F MAX RAD RTD: 535° F MAX CONV RTD: 540° F</p> <p><b>NEXT TEST</b>      <b>PREV TEST</b></p> <p><b>CANCEL</b>          <b>CLEAR INFO</b></p>	<p>This screen will show the temperatures being reported to the RTD's in the oven. The maximum temps seen by the controller are also recorded for diagnostic purposes.</p> <p><b>NEXT TEST:</b> Press this pad to go to the next Service Mode Test</p> <p><b>PREV TEST:</b> Press this pad to go to the previous Service Mode Test</p> <p><b>CANCEL:</b> Press this pad to return to the Main Menu</p> <p><b>CLEAR INFO:</b> Press this pad to reset the Maximum RTD temps to zero.</p>

# Service Test AXP20 / MXP20

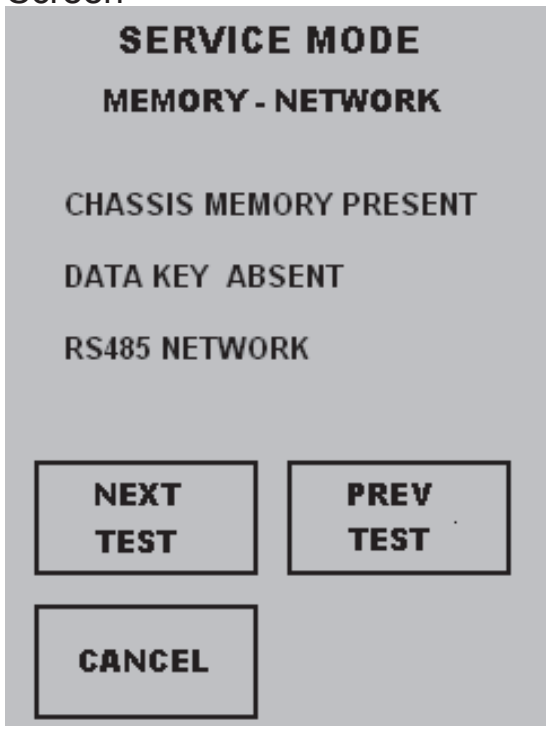
Memory / Network Status	12
<p>Screen</p>  <p><b>SERVICE MODE</b> <b>MEMORY - NETWORK</b></p> <p>CHASSIS MEMORY PRESENT DATA KEY ABSENT RS485 NETWORK</p> <p><b>NEXT TEST</b>      <b>PREV TEST</b></p> <p><b>CANCEL</b></p>	<p>This screen will show which memory chips are present and if the oven is hooked up to an external network.</p> <p><b>NEXT TEST:</b> Press this pad to go to the next Service Mode Test</p> <p><b>PREV TEST:</b> Press this pad to go to the previous Service Mode Test</p> <p><b>CANCEL:</b> Press this pad to return to the Main Menu</p>

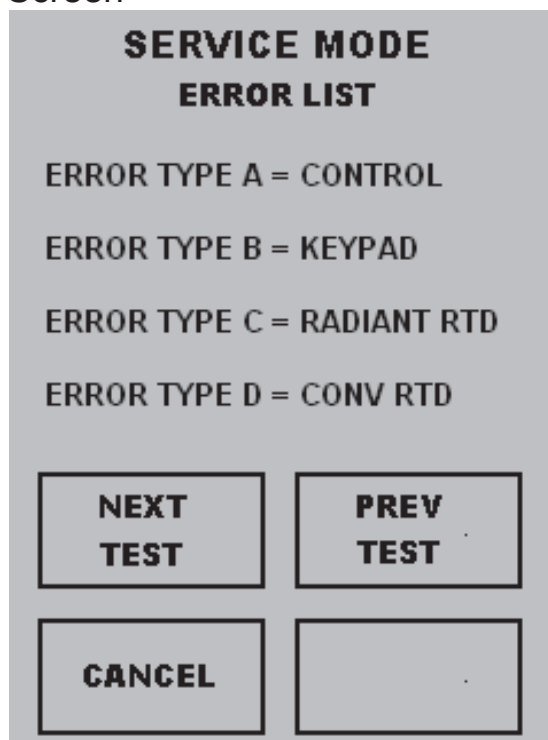
Error List	13
<p>Screen</p>  <p><b>SERVICE MODE</b> <b>ERROR LIST</b></p> <p>ERROR TYPE A = CONTROL ERROR TYPE B = KEYPAD ERROR TYPE C = RADIANT RTD ERROR TYPE D = CONV RTD</p> <p><b>NEXT TEST</b>      <b>PREV TEST</b></p> <p><b>CANCEL</b>      [Empty Button]</p>	<p>This screen will show a description of the types of errors that can occur.</p> <p><b>NEXT TEST:</b> Press this pad to go to the next Service Mode Test</p> <p><b>PREV TEST:</b> Press this pad to go to the previous Service Mode Test</p> <p><b>CANCEL:</b> Press this pad to return to the Main Menu</p>

# Service Test AXP20 / MXP20

## Error History

14

Screen

**SERVICE MODE  
ERROR HISTORY**

1) G2  
2) C0  
3) H1  
4) B0

**NEXT TEST**      **PREV TEST**

**CANCEL**          **SCROLL**

This screen will show the previous error codes that have occurred in the oven.

**NEXT TEST:** Press this pad to go to the next Service Mode Test

**PREV TEST:** Press this pad to go to the previous Service Mode Test

**SCROLL:** This pad will advance through the history of the error codes. (1-10)

**CANCEL:** Press this pad to return to the Main Menu

**Note:** To clear codes: Press and hold Pad 1 until Code(s) disappear.

## Voltage Switching

15

Screen

**SERVICE MODE  
VOLTAGE SWITCHING**

LINE VOLTAGE = 208 VAC

**NEXT TEST**      **PREV TEST**

**CANCEL**

This screen will show the line voltage detected by the oven.

**NEXT TEST:** Press this pad to go to the next Service Mode Test

**PREV TEST:** Press this pad to go to the previous Service Mode Test

**CANCEL:** Press this pad to return to the Main Menu

# 9 | **AXP20 / MXP20 60 Hz Troubleshooting**

# Troubleshooting AXP20 / MXP20

## POWER UP CONDITION

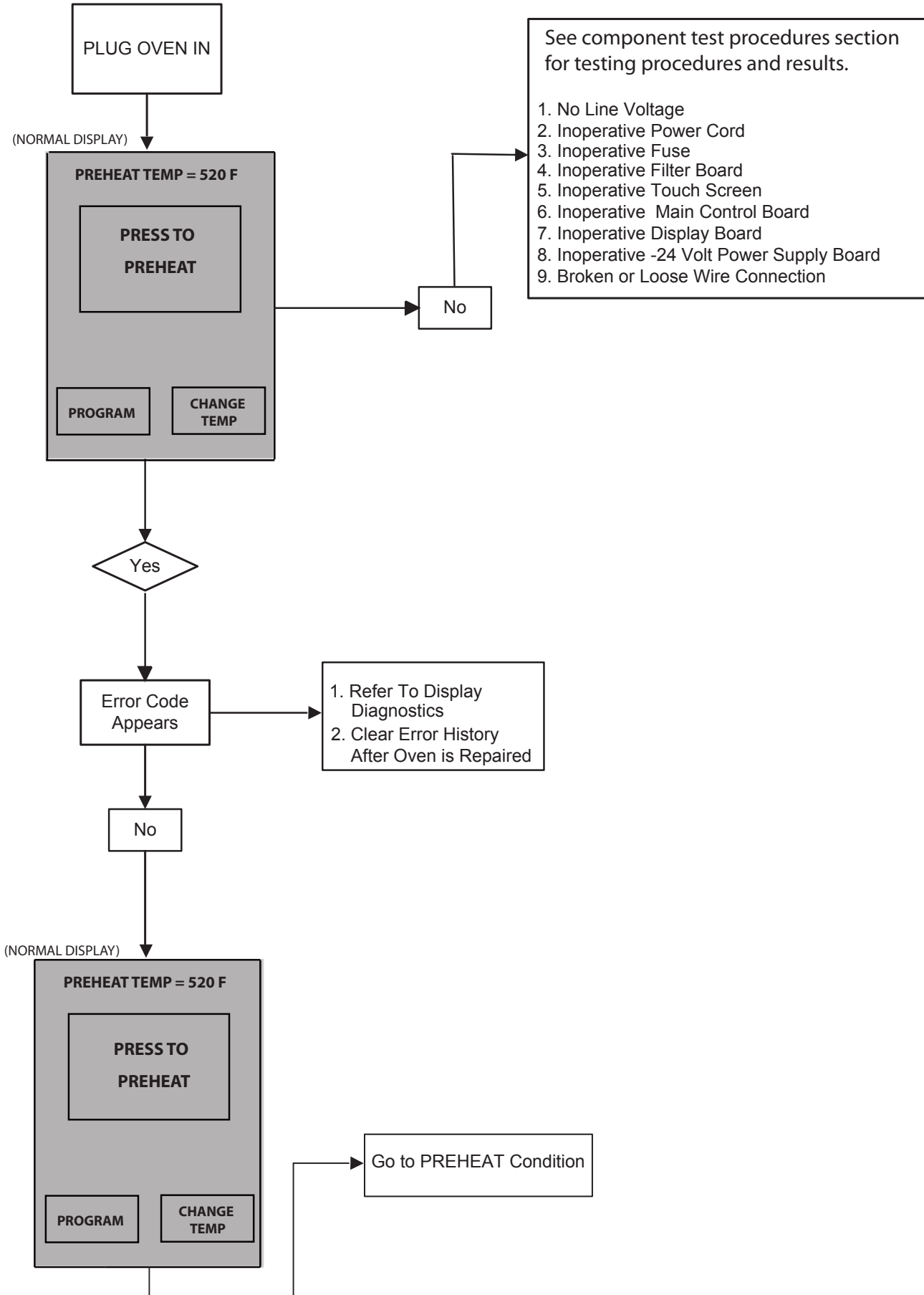

# Troubleshooting AXP20 / MXP20

## PREHEAT CONDITION

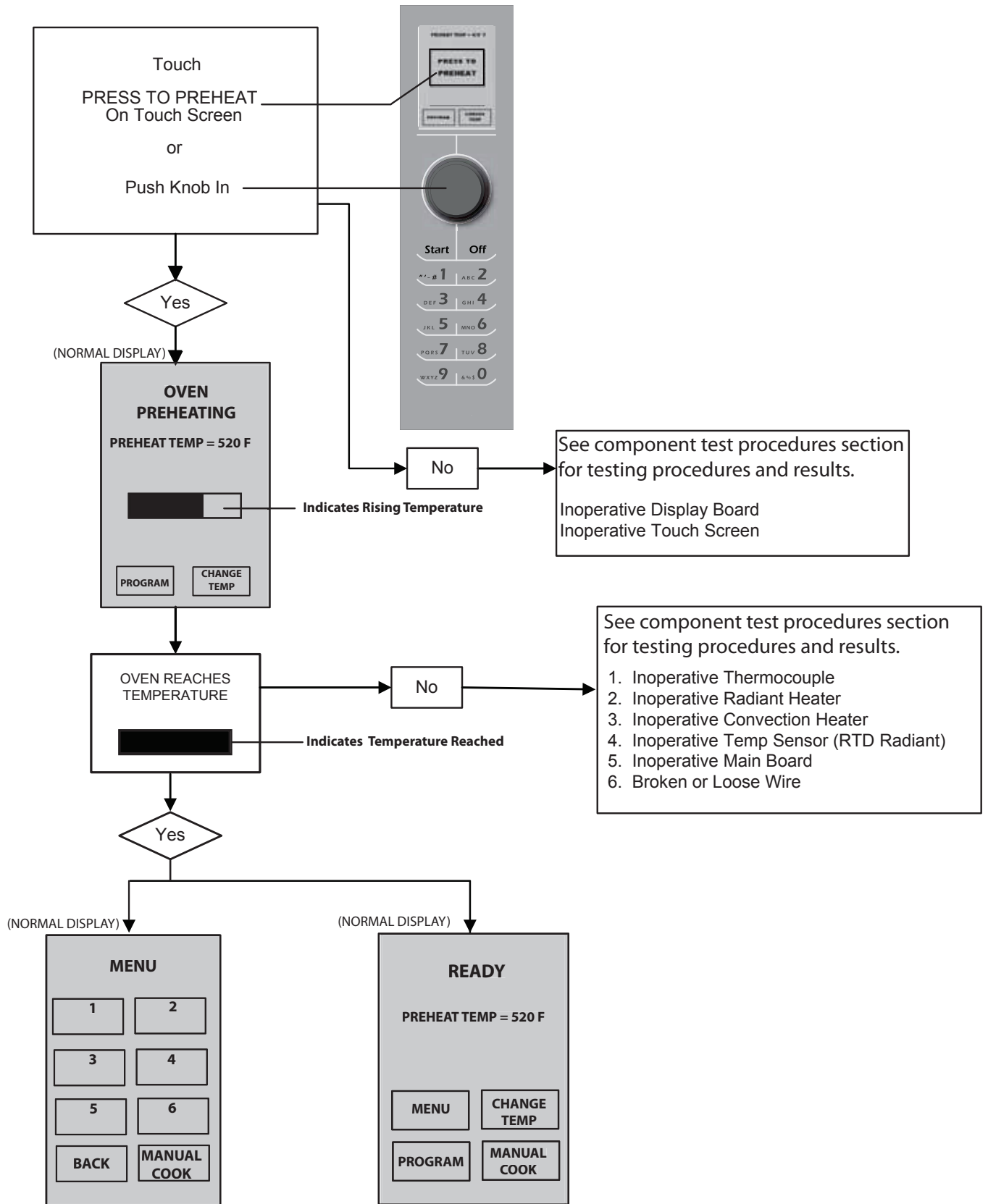

# Troubleshooting AXP20 / MXP20

## MICROWAVE CONDITION

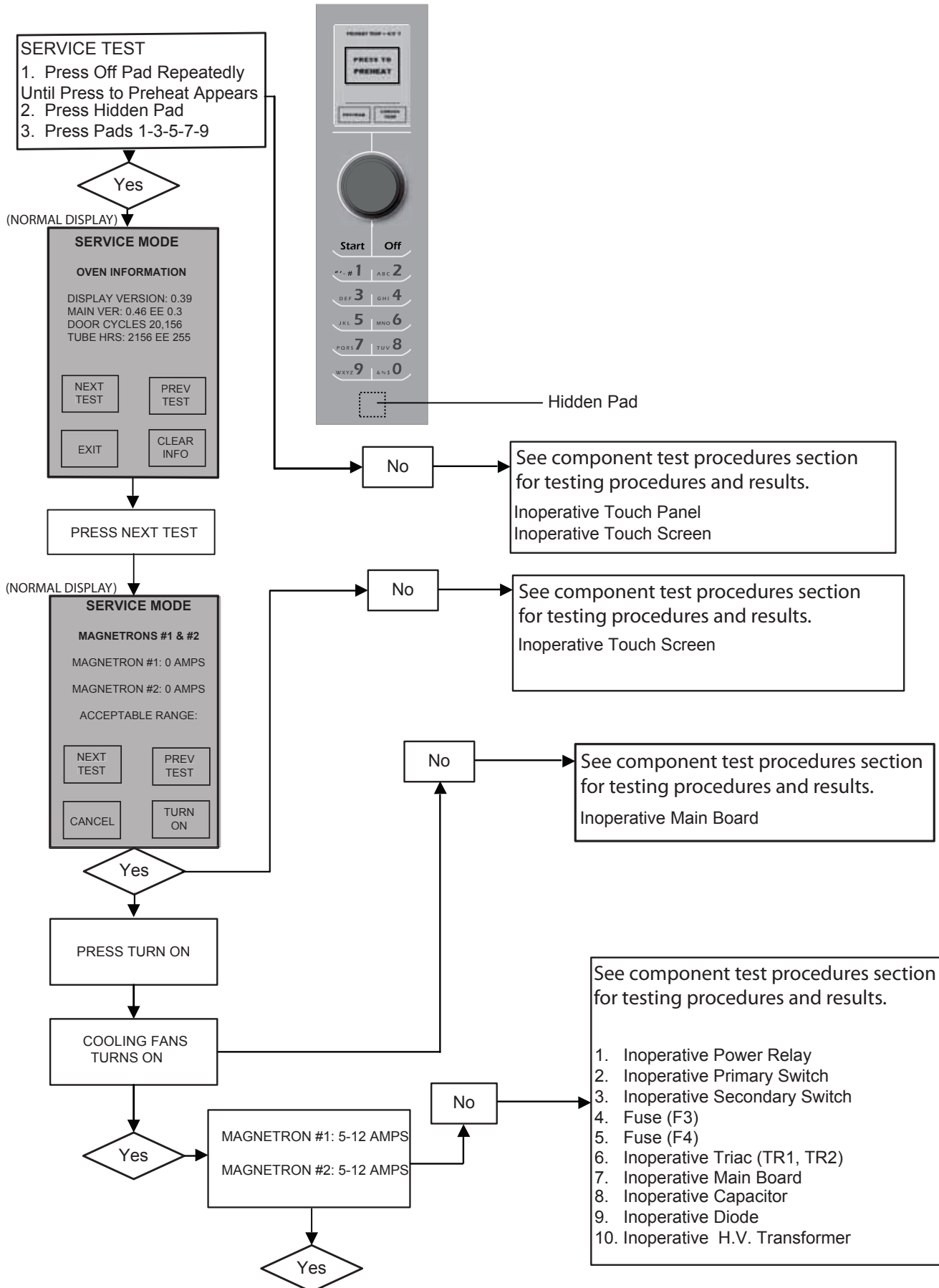

# Troubleshooting AXP20 / MXP20

## OPERATIONAL CODES

During oven operation the display may indicate one of the following:

CALL SERVICE  
CODE G0

1. When you press the pad/ knob to preheat the oven the display indicates.
2. During cooking, the oven display indicates.

1. Unplug / plug oven in  
2. If code continues to appear replace Electronic Limiter.  
3. If code continues to appear after replacing Electronic Limiter replace Thermocouple.  
**Note:** When replacing thermocouple position the thermocouple in the same position in the cabinet as the original thermocouple.

DOOR  
OPEN

1. After food is placed in the oven the door is closed the display indicates.

See component test procedures section for testing procedures and results.

1. Inoperative Monitor Switch
2. Interlock Switch Assembly out of adjustment
3. Broken or loose wire connection

CLOSE DOOR  
PLACE FOOD  
IN OVEN

1. After food is placed in the oven the door is closed the display indicates.

See component test procedures section for testing procedures and results.

1. Interlock Switch Assembly out of adjustment
2. Inoperable Monitor Switch
3. Broken or loose wire connection

# Troubleshooting AXP20 / MXP20

## OPERATIONAL CODES

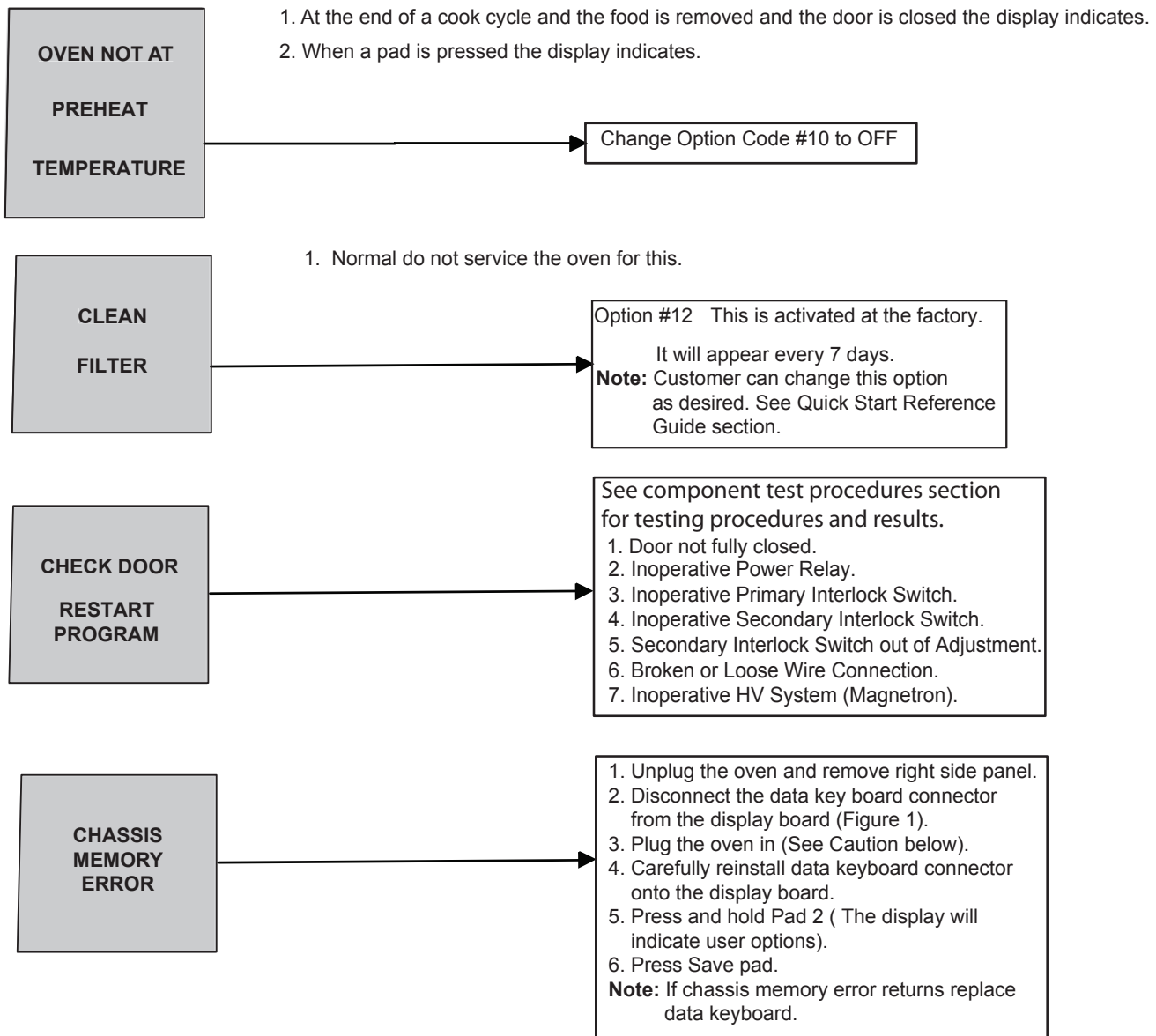

Data Key Connector

Figure 1

**CAUTION**

Oven is energized, use care when plugging connector into data key board.

# 10 | **AXP20 / MXP20 60 Hz** **Display Diagnostics**

# Display Diagnostics AXP20 / MXP20

## Error Codes

Display	Description	Corrective Action
A0	Main Board	Replace main board
A2	Display Board	Replace display board
B0	Touch Panel	Replace Touch Panel
B1	Touch Panel	Replace Touch Panel
C-0	Temp Sensor (RTD) (open)	Replace Temp Sensor
C-1	Temp Sensor (RTD) (shorted)	Replace Temp Sensor
C-2	Temp Sensor (RTD) (out of range)	Replace Temp Sensor
D-0	Thermocouple (RTD) (open)	Replace Thermocouple
D-1	Thermocouple (RTD) (shorted)	Replace Thermocouple
D-2	Thermocouple (RTD) (out of range)	Replace Thermocouple
G-0	Oven Exceeded Max. Temp.	Unplug / Plug oven in If G-0 continues to appear: 1. Check wire connector on main board J7-1,2 2. Test thermocouple / RTD and replace if necessary. 3. If thermocouple/ RTD test good replace electronic limiter.
G-2	Magnetron TCO	Perform service test (Magnetron #1 & #2)
G-2	Cooling Motor	Perform service test (Cooling Fan)
H-0	Signal Missing	Plug disconnected from J1 on main board
H-1	Main Board Set Point Incorrect.	Unplug / Plug oven in
H-2	Main Board	Replace main board
H-3	Main Board	Replace main board
M-0	Current Sense Low Amps	Perform service test (Magnetron #1 & #2)
M-1	Magnetron 1 Low Amps	Perform service test (Magnetron #1)
M-2	Magnetron 2 Low Amps	Perform service test (Magnetron #2)

**Note:** While in the service test the error history can be cleared by pressing and holding Pad 1.

# **1 1 | AXP22 / MXP22 60 Hz Service Test**

# Service Test AXP22 / MXP22

## Access to Service Mode

Screen

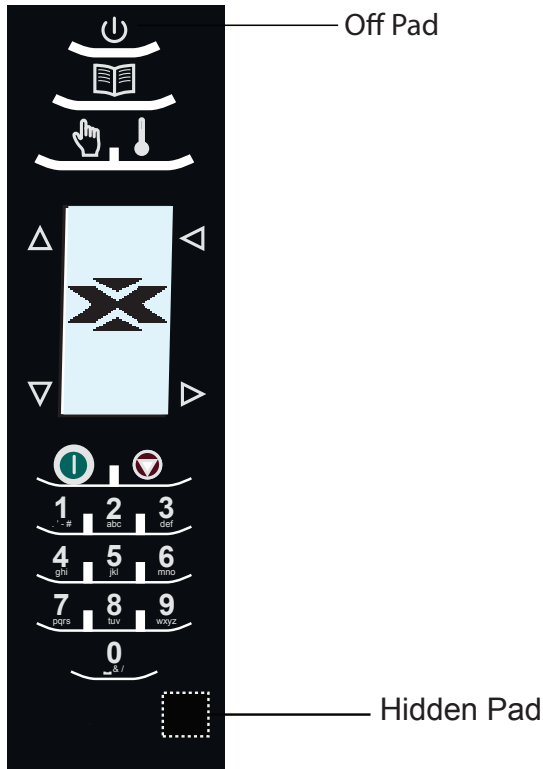

While in the OFF mode, press the following sequence on the keypad:

1. Press OFF pad until  Icon appears.
  2. Press Hidden Pad.
  3. Press pads 1 - 3 - 5 - 7 - 9
- The display indicates SERVICE MODE.

## Oven Information

1

Screen

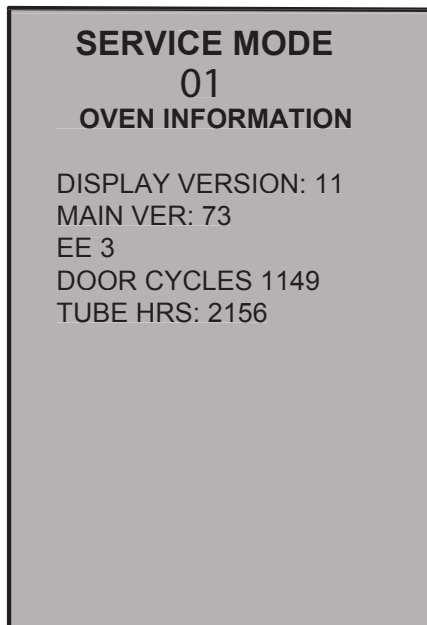

This screen is Oven Information showing the versions of software in the control boards and information about door cycles and tube hours.



Press this pad to go to the next Service Mode Test



Press this pad to go to the previous Service Mode Test

Press 0 pad for 5 seconds to reset the Door Cycles and Tube Hours back to zero.



Press this pad repeatedly to exit Service Mode.

# Service Test AXP22 / MXP22

## Manual Operation of Magnetrons #1

2

Screen

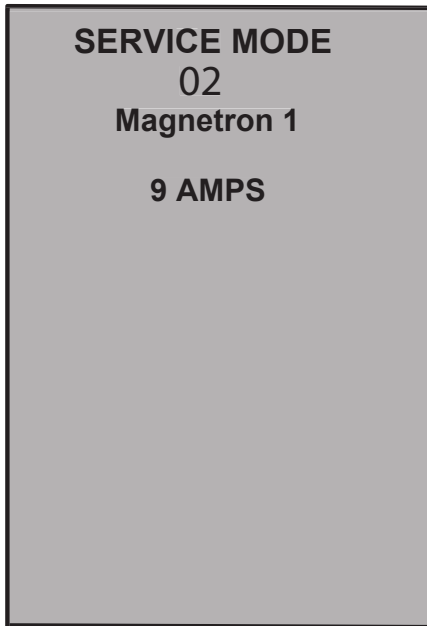

This screen will allow operation of Magnetron #1 and show the number of amps being drawn.



Press this pad to go to the next Service Mode Test



Press this pad to go to the previous Service Mode Test



This pad will turn the magnetron on.



This pad will turn the magnetron off.



Press this pad repeatedly to exit Service Mode

**RANGE:** Under normal operation, each mag's amp draw should be **5 – 12 amps**.

## Manual Operation of Magnetron #2

3

Screen

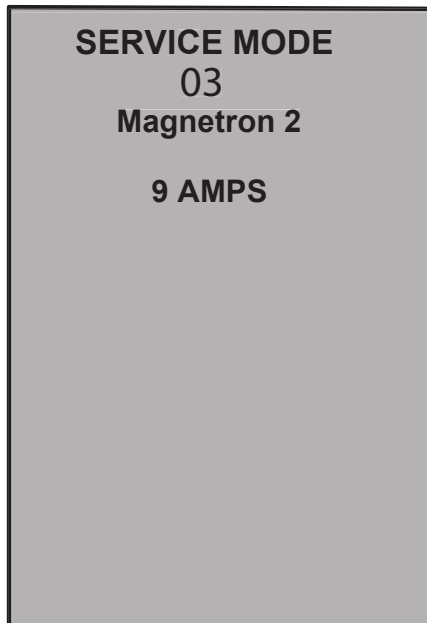

This screen will allow operation of Magnetron #2 and show the number of amps being drawn.



Press this pad to go to the next Service Mode Test



Press this pad to go to the previous Service Mode Test



This pad will turn the magnetron on.



This pad will turn the magnetron off.



Press this pad repeatedly to exit Service Mode.

**RANGE:** Under normal operation, each mag's amp draw should be **5 – 12 amps**.

# Service Test AXP22 / MXP22

## Convection Heater

5

Screen

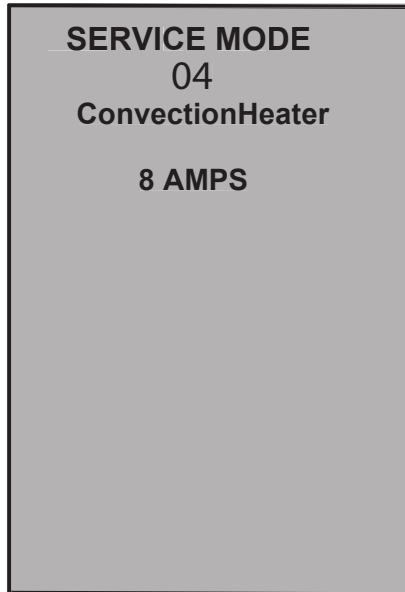

This screen will allow operation of the convection heater and show the number of amps being drawn.



Press this pad to go to the next Service Mode Test



Press this pad to go to the previous Service Mode Test



This pad will turn the heater on.



This pad will turn the heater off.



Press this pad repeatedly to exit Service Mode.

**RANGE:** Under normal operation, the amp draw should be **5 – 12 amps**.

## Radiant Heater

6

Screen

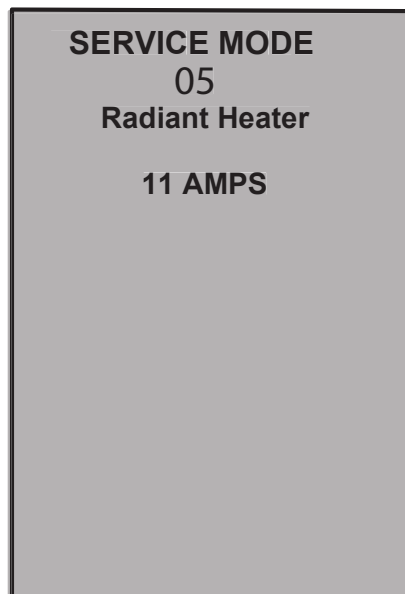

This screen will allow operation of the radiant heater and show the number of amps being drawn.



Press this pad to go to the next Service Mode Test



Press this pad to go to the previous Service Mode Test



This pad will turn the heater on.



This pad will turn the heater off.



Press this pad repeatedly to exit Service Mode.

**RANGE:** Under normal operation, the amp draw should be **10 – 16 amps**.

# Service Test AXP22 / MXP22

## Convection Fan – Low Speed

7

Screen

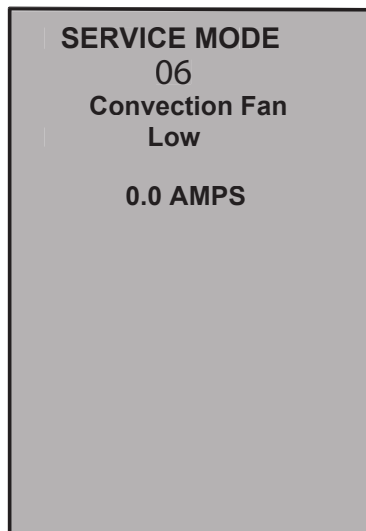

This screen will allow operation of the convection fan at a low speed and show the number of amps being drawn.



Press this pad to go to the next Service Mode Test



Press this pad to go to the previous Service Mode Test



This pad will turn the fan on low speed.



This pad will turn the fan off.



Press this pad repeatedly to exit Service Mode

**RANGE:** Under normal operation, the amp draw is too low to read.

## Convection Fan – High Speed

8

Screen

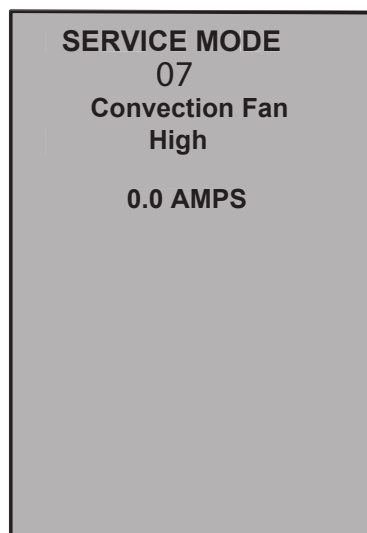

This screen will allow operation of the convection fan at a high speed and show the number of amps being drawn.



Press this pad to go to the next Service Mode Test



Press this pad to go to the previous Service Mode Test



This pad will turn the fan on high speed.



This pad will turn the fan off.



Press this pad repeatedly to exit Service Mode

**RANGE:** Under normal operation the amp draw is too low to read.

# Service Test AXP22 / MXP22

## Cooling Fan

9

Screen

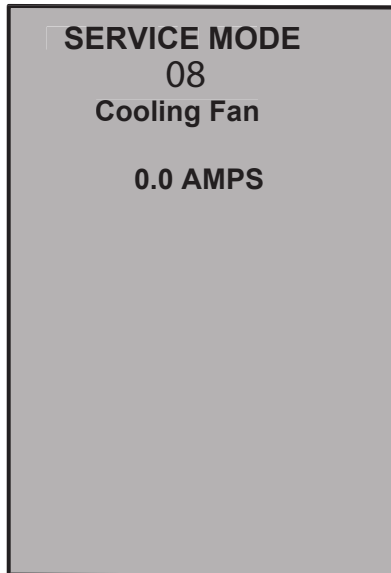

This screen will allow operation of the cooling fan and show the number of amps being drawn.



Press this pad to go to the next Service Mode Test.



Press this pad to go to the previous Service Mode Test.



This pad will turn the fan on.



This pad will turn the fan off.



Press this pad repeatedly to exit Service Mode.

**RANGE:** Under normal operation, the amp draw should be **0.9 - 2.5 amps**. (It may not read amps)

## Antenna Motors

10

Screen

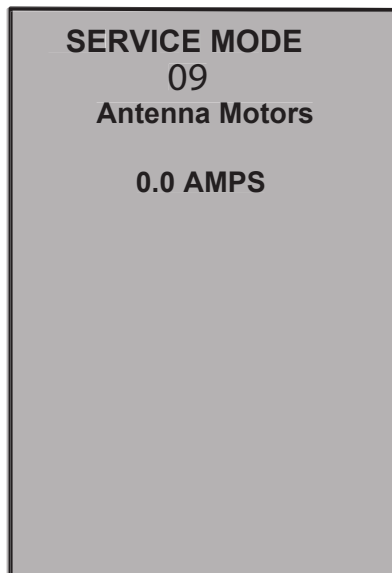

This screen will allow operation of the antenna motors and show the number of amps being drawn.



Press this pad to go to the next Service Mode Test.



Press this pad to go to the previous Service Mode Test.



This pad will turn the antenna motors on.



This pad will turn the antenna motors off.



Press this pad repeatedly to exit Service Mode.

**RANGE:** Under normal operation, the amp draw may be too low to read.

# Service Test AXP22 / MXP22

## RTD Status

11

Screen

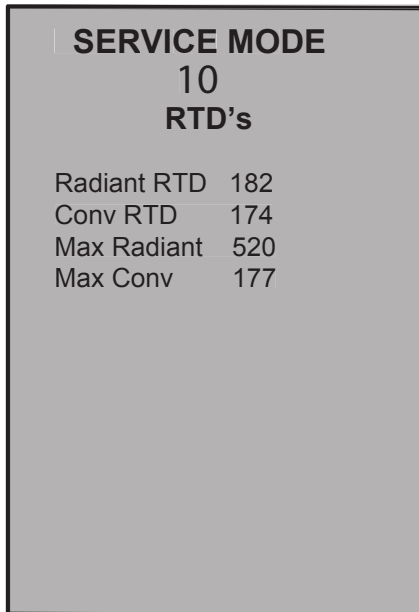

This screen will show the temperatures being reported to the RTD's in the oven. The maximum temps seen by the controller are also recorded for diagnostic purposes.



Press this pad to go to the next Service Mode Test.



Press this pad to go to the previous Service Mode Test.



Press this pad repeatedly to exit Service Mode

Press the 0 pad for 5 seconds to reset the Maximum RTD temps to zero.

## Memory / Network Status

12

Screen

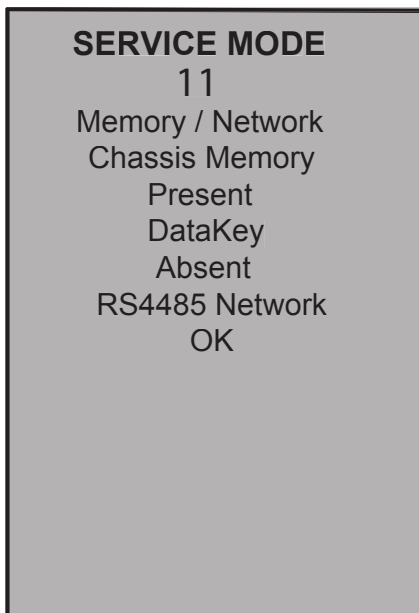

This screen will show which memory chips are present and if the oven is hooked up to an external network.



Press this pad to go to the next Service Mode Test.



Press this pad to go to the previous Service Mode Test.



Press this pad repeatedly to exit Service Mode

# Service Test AXP22 / MXP22

## Error List

13

Screen

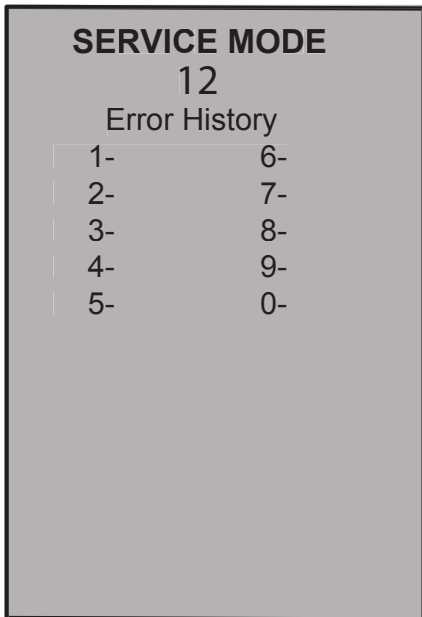

This screen will show a description of the types of errors that can occur.



Press this pad to go to the next Service Mode Test.



Press this pad to go to the previous Service Mode Test.



Press this pad repeatedly to exit Service Mode

**Note:** Most recent Error listed in #1 position. Press 0 to clear Error History.

## Voltage Switching

14

Screen

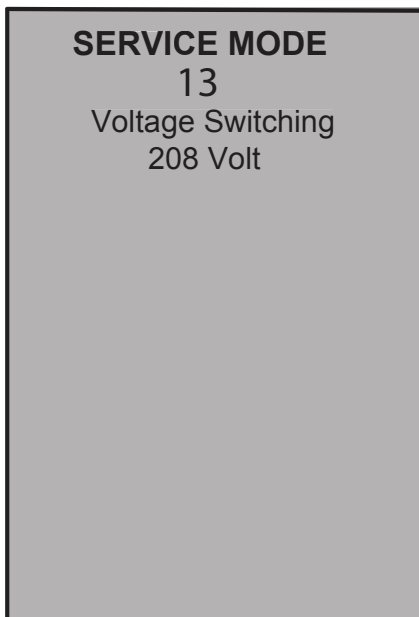

This screen will show the line voltage detected by the oven.



Press this pad to go to the next Service Mode Test.



Press this pad to go to the previous Service Mode Test.



Press this pad repeatedly to exit Service Mode

# 12 | **AXP22 / MXP22 60 Hz Troubleshooting**

# Troubleshooting AXP22 / MXP22

## POWER UP CONDITION

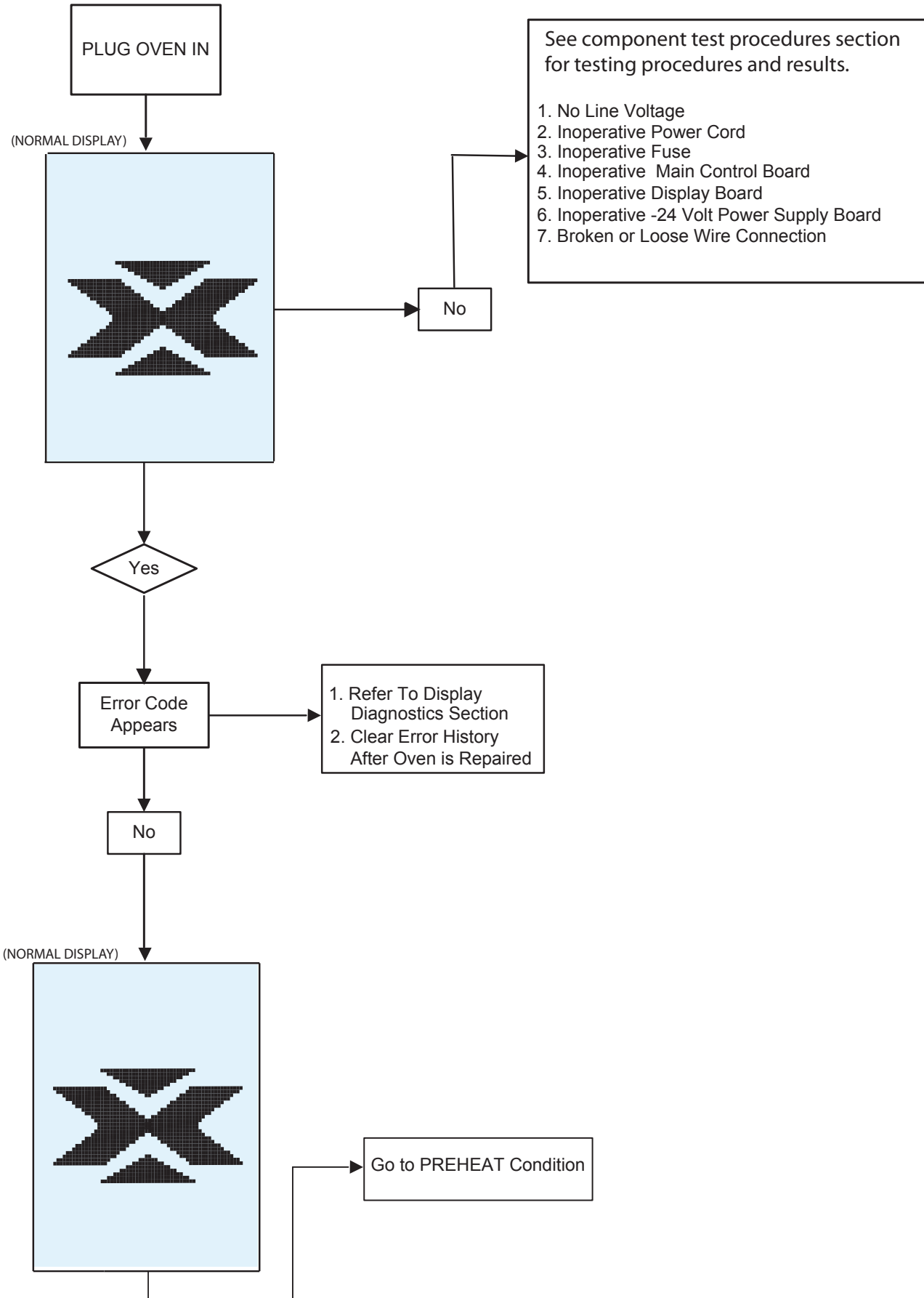

# Troubleshooting AXP22 / MXP22

## PREHEAT CONDITION

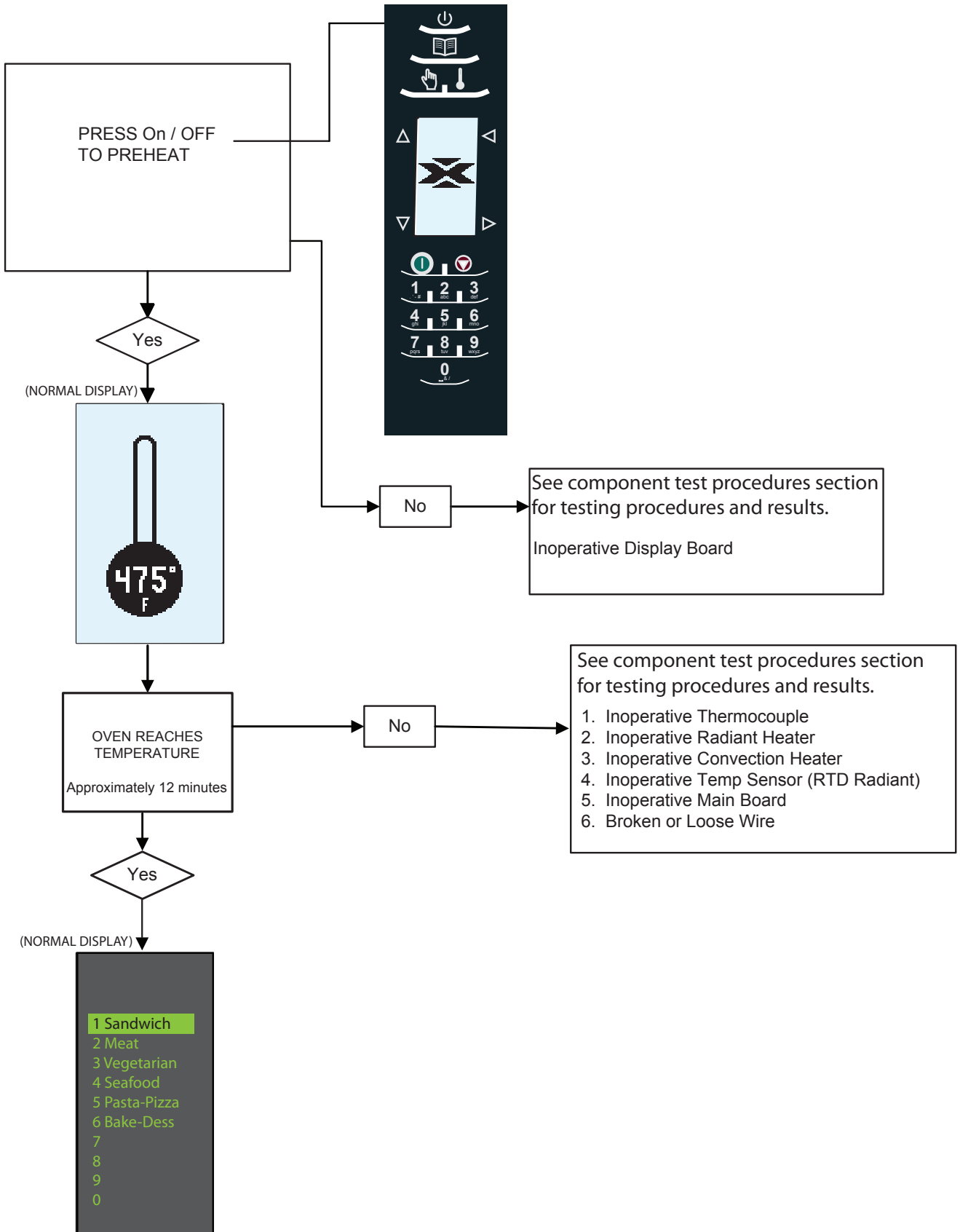

# Troubleshooting AXP22 / MXP22

## MICROWAVE CONDITION

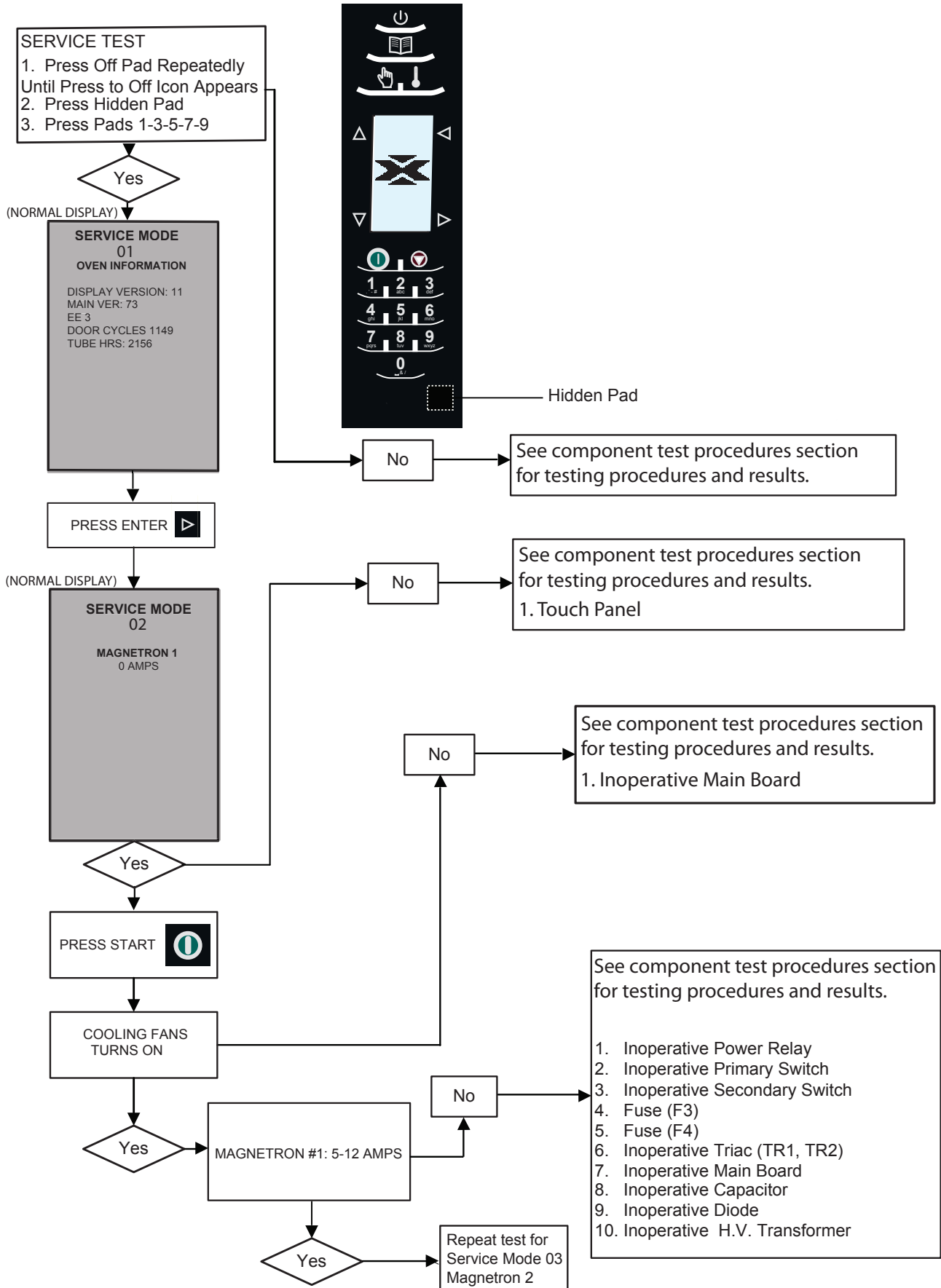

# Troubleshooting AXP22 / MXP22

## OPERATIONAL CODES

During oven operation the display may indicate one of the following:

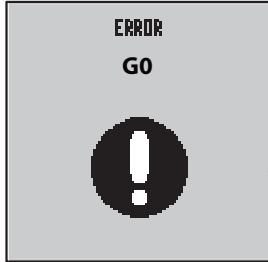

1. When you press the pad to preheat the oven the display indicates.
2. During cooking, the oven display indicates.

Unplug / plug oven in  
If G-0 continues to appear:

1. Check wire connector on main board J7-1,2
2. Test thermocouple / RTD and replace if necessary.
3. If thermocouple/ RTD test good replace electronic limiter.

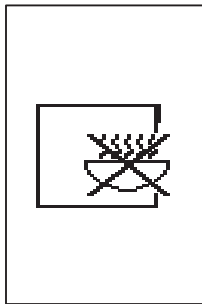

Check Door

1. Door not fully closed.
2. Inoperative Power Relay.
3. Inoperative Primary Interlock Switch.
4. Inoperative Secondary Interlock Switch.
5. Interlock Switch Assembly out of Adjustment.
6. Broken or Loose Wire Connection.
7. Inoperative HV System (Magnetron).

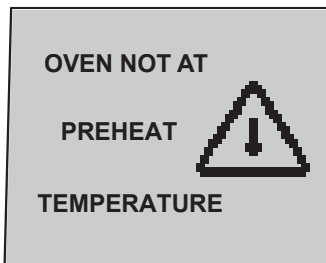

Preheat Warning

1. At the end of a cook cycle and the food is removed and the door is closed the display indicates.
2. When a pad is pressed the display indicates.

Change Option Code #12 to OFF

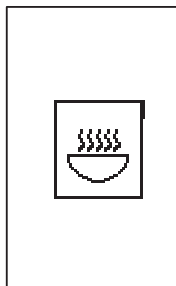

1. After food is placed in the oven the door is closed the display indicates.
2. During a cook cycle the oven stops.

1. End of cook cycle oven is operating normally.

# Troubleshooting AXP22 / MXP22

## OPERATIONAL CODES

Appetizers-Side  
Miscellaneous  
Tater Tots 6oz



Pause

1. During the cook cycle the door is opened or the stop key is pressed once the display indicates. (This is normal operation).
2. Press start key to continue cook cycle or press stop key twice to cancel cook cycle.

### To disable pause feature:

Change Option Code #07 to Opening door resets timer to disable feature.

CHASSIS  
MEMORY  
ERROR

1. Unplug the oven and remove right side panel.
  2. Disconnect the data key board connector from the display board (Figure 1).
  3. Plug the oven in (See Caution below).
  4. Carefully reinstall data keyboard connector onto the display board.
  5. Press and hold Pad 2 ( The display will indicate user options).
  6. Press Save pad.
- Note:** If chassis memory error returns replace data keyboard.

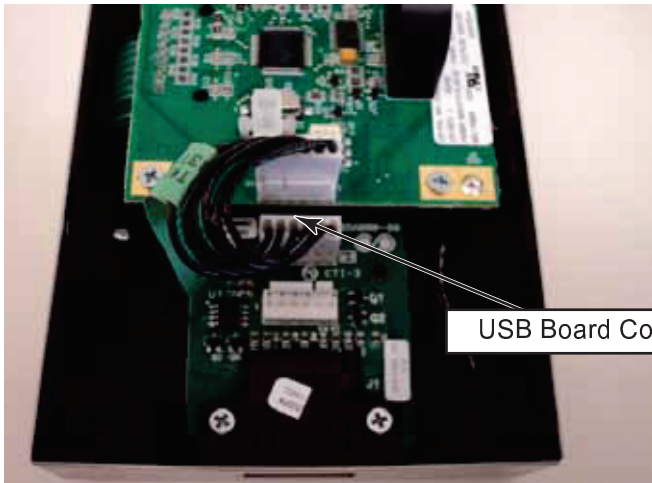

USB Board Connector

### CAUTION

Oven is energized, use care when plugging connector into data key board.

CLEAN  
FILTER

1. Normal operation do not service the oven for this.

Option #12 This is activated at the factory.

It will appear every 7 days.

**Note:** Customer can change this option as desired. See Quick Start Reference Guide section.

# 13 | **AXP22 / MXP22 60 Hz Display Diagnostics**

# Display Diagnostics AXP22 / MXP22

## Error Codes

Display	Description	Corrective Action
A0	Main Board	Replace main board
A2	Display Board	Replace display board
B1	Touch Panel	Replace touch panel
B0	Touch Panel	Replace Touch Panel
C0	Temp Sensor (RTD) (open)	Replace temp sensor
C1	Temp Sensor (RTD) (shorted)	Replace temp sensor
C2	Temp Sensor (RTD) (out of range)	Replace temp sensor
D0	Thermocouple (RTD) (open)	Replace thermocouple
D1	Thermocouple (RTD) (shorted)	Replace thermocouple
D-2	Thermocouple (RTD) (out of range)	Replace Thermocouple
G0	Oven Exceeded Max. Temp.	Unplug / Plug oven in If G-0 continues to appear: 1. Check wire connector on main board J7-1,2 2. Test thermocouple / RTD and replace if necessary. 3. If thermocouple/ RTD test good replace electronic limiter.
G2	Magnetron TCO	Perform service test (Magnetron #1 & #2)
G2	Cooling Motor	Perform service test (Cooling Fan)
H0	Signal Missing	Plug disconnected from J1 on main board
H1	Main Board Set Point Incorrect.	Unplug / Plug oven in
H2	Main Board	Replace main board
H3	Main Board	Replace main board

**Note:** While in the service test the error history can be cleared by pressing and holding Pad 0.

# **14 | AXP20 / MXP20 , AXP22 / MXP22 60 Hz Wiring Diagrams / Schematics**

# Wiring Diagram Sample AXP20

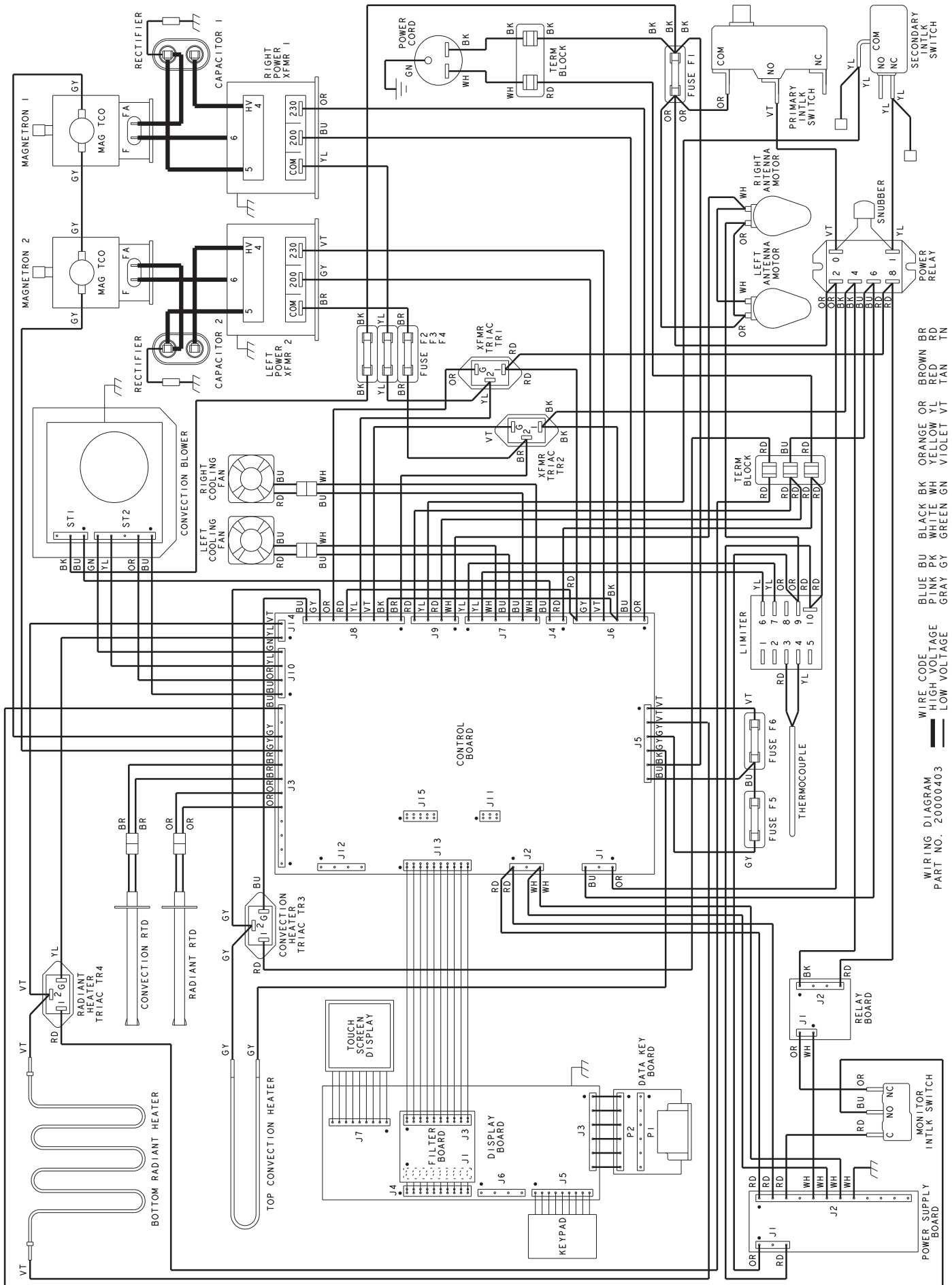

WIRING DIAGRAM  
PART NO. 20000403

WIRE CODE  
 HIGH VOLTAGE  
 LOW VOLTAGE

BLUE BU  
 PINK PK  
 GRAY GY  
 BLACK BK  
 WHITE WH  
 GREEN GN  
 ORANGE OR  
 YELLOW YL  
 VIOLET VT  
 BROWN BR  
 RED RD  
 TAN TN

# Schematic Sample AXP20

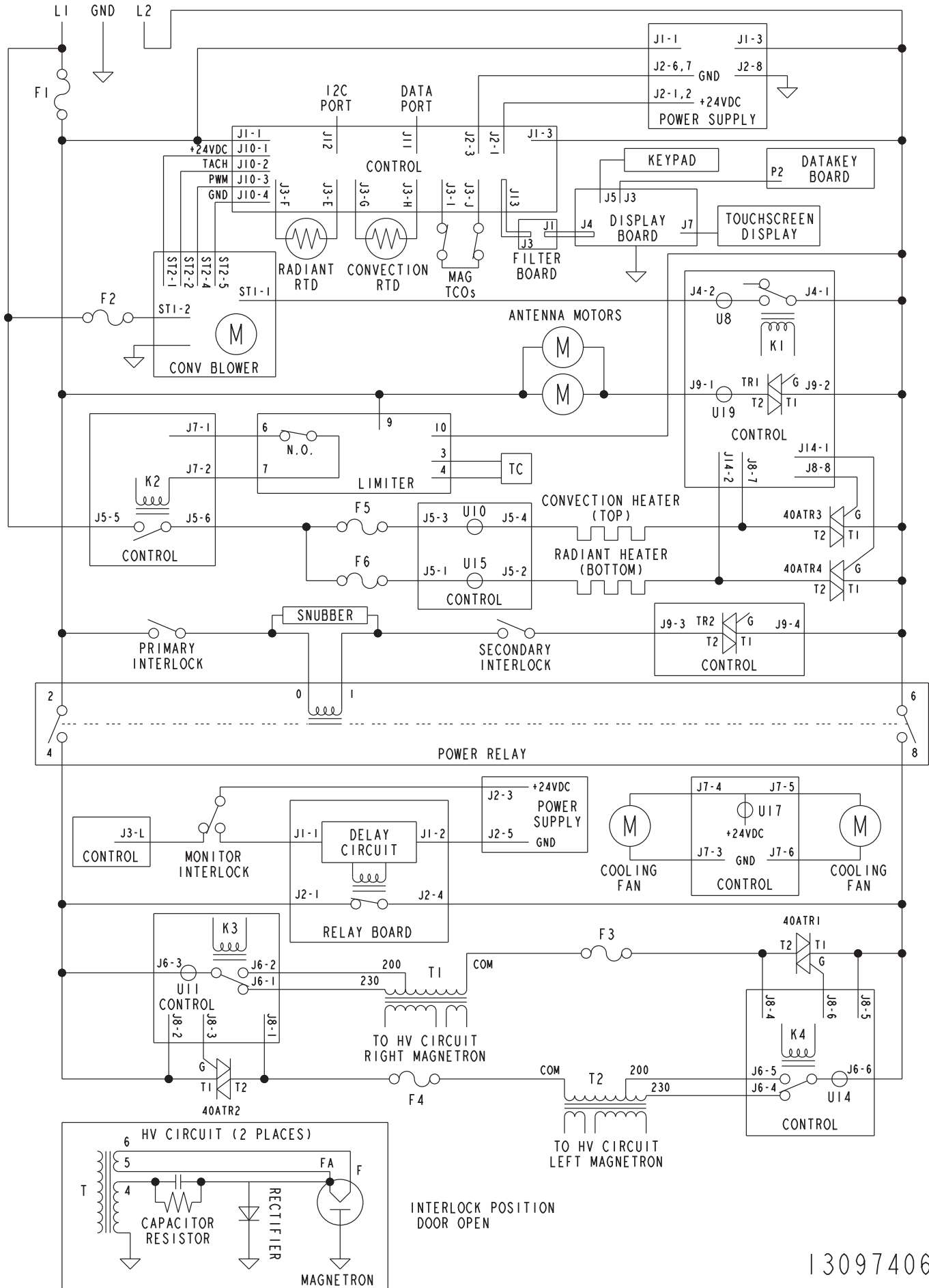

13097406

# Wiring Diagram Sample AXP22 / MXP22QT

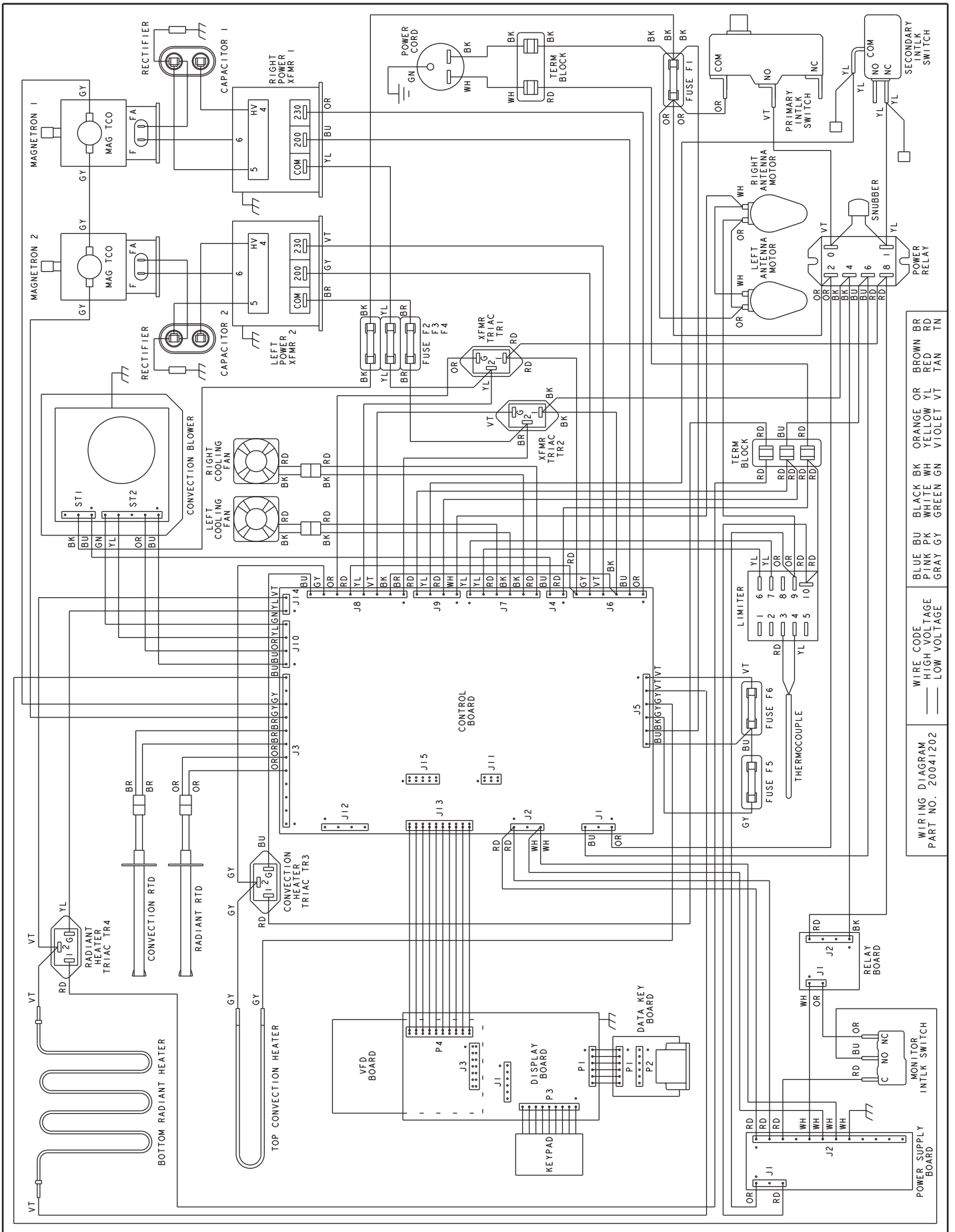

# Wiring Schematic Sample AXP22 / MXP22QT

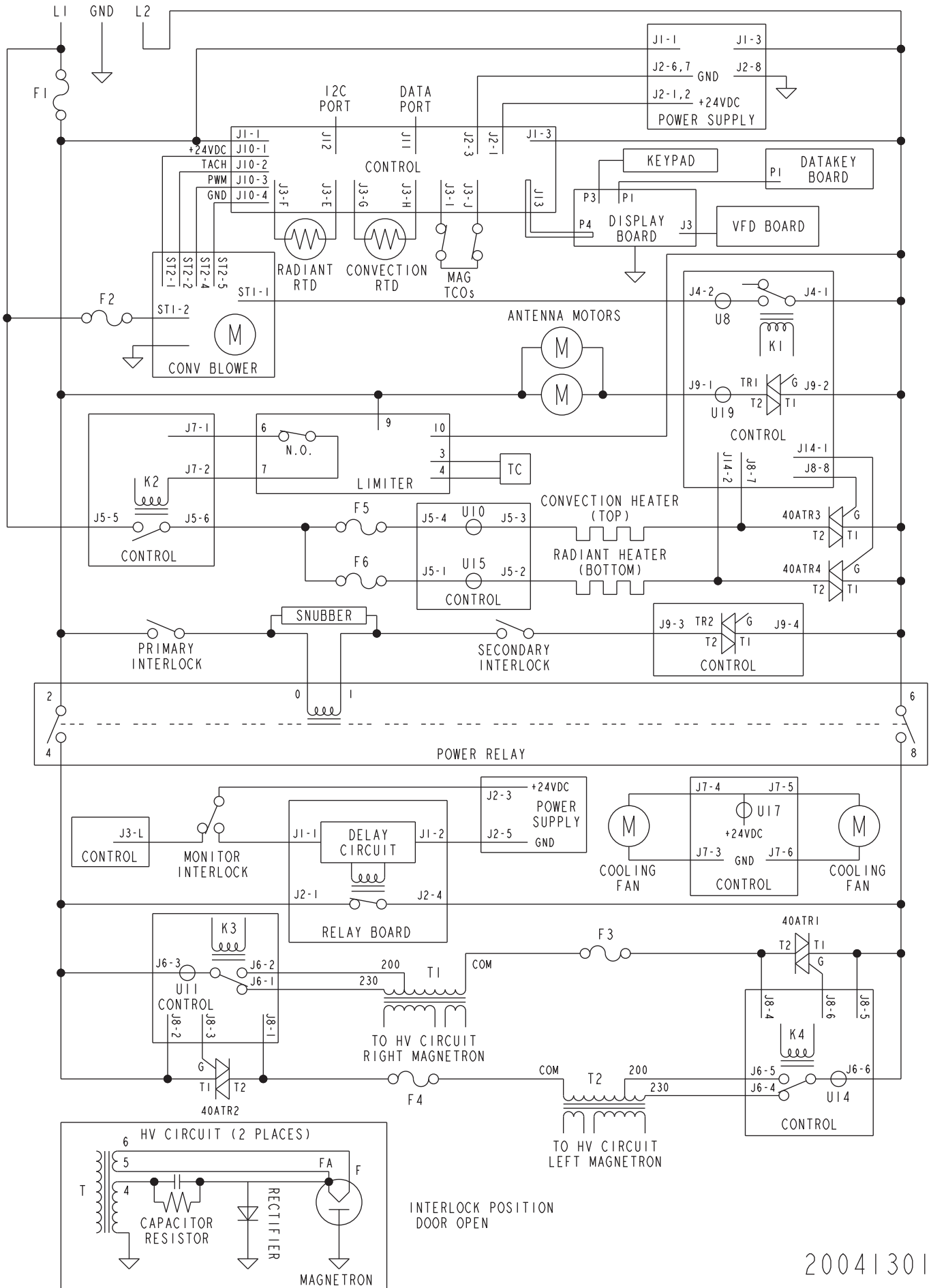

20041301

