

**ALTO SHAAM®**

# **Island Takeout Merchandiser**



**Models:  
ITM-48  
ITM-72**



- **INSTALLATION**
- **OPERATION**
- **MAINTENANCE**

**HALO  
HEAT®**

**24•7**  
Your Service Hotline  
1-800-558-8744

W164 N9221 Water Street • P.O. Box 450 • Menomonee Falls, Wisconsin 53052-0450 USA

PHONE: 262.251.3800 • 800.558.8744 USA/CANADA

FAX: 262.251.7067 • 800.329.8744 U.S.A. ONLY

WEBSITE: [www.alto-shaam.com](http://www.alto-shaam.com)

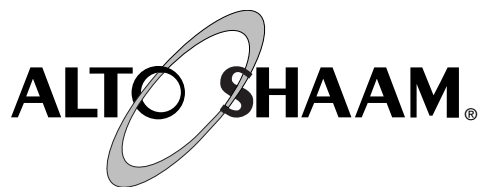

## DELIVERY

This Alto-Shaam appliance has been thoroughly tested and inspected to insure only the highest quality unit is provided. Upon receipt, check for any possible shipping damage and report it at once to the delivering carrier. *See Transportation Damage and Claims section located in this manual.*

This appliance, complete with unattached items and accessories, may have been delivered in one or more packages. Check to ensure that all standard items and options have been received with each model as ordered.

Save all the information and instructions packed with the appliance. Complete and return the warranty card to the factory as soon as possible to assure prompt service in the event of a warranty parts and labor claim.

This manual must be read and understood by all people using or installing the equipment model. Contact the Alto-Shaam service department if you have any questions concerning installation, operation, or maintenance.

**NOTE:** All claims for warranty must include the full model number and serial number of the unit.

## UNPACKING

1. Carefully remove the appliance from the carton or crate.

**NOTE:** Do not discard the carton and other packaging material until you have inspected the unit for hidden damage and tested it for proper operation.

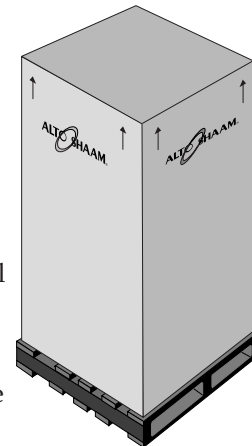

2. Read all instructions in this manual carefully before initiating the installation of this appliance.

### **DO NOT DISCARD THIS MANUAL.**

This manual is considered to be part of the appliance and is to be provided to the owner or manager of the business or to the person responsible for training operators. *Additional manuals are available from the Alto-Shaam service department.*

3. Remove all protective plastic film, packaging materials, and accessories from the appliance before connecting electrical power. Store any accessories in a convenient place for future use.

# SAFETY PROCEDURES AND PRECAUTIONS

Knowledge of proper procedures is essential to the safe operation of electrically and/or gas energized equipment. In accordance with generally accepted product safety labeling guidelines for potential hazards, the following signal words and symbols may be used throughout this manual.

 <b>DANGER</b>	Used to indicate the presence of a hazard that <b>will</b> cause severe personal injury, death, or substantial property damage if the warning included with this symbol is ignored.
---	---

 <b>WARNING</b>	Used to indicate the presence of a hazard that <b>can</b> cause personal injury, possible death, or major property damage if the warning included with this symbol is ignored.
--	--

 <b>CAUTION</b>	Used to indicate the presence of a hazard that can or will cause minor or moderate personal injury or property damage if the warning included with this symbol is ignored.
--	--

<b>CAUTION</b>	Used to indicate the presence of a hazard that can or will cause minor personal injury, property damage, or a potential unsafe practice if the warning included with this symbol is ignored.
----------------	--

<b>NOTE:</b>	Used to notify personnel of installation, operation, or maintenance information that is important but not hazard related.
--------------	---

1. This appliance is intended to cook, hold or process foods for the purpose of human consumption. No other use for this appliance is authorized or recommended.
2. This appliance is intended for use in commercial establishments where all operators are familiar with the purpose, limitations, and associated hazards of this appliance. Operating instructions and warnings must be read and understood by all operators and users.
3. Any troubleshooting guides, component views, and parts lists included in this manual are for general reference only and are intended for use by qualified technical personnel.
4. This manual should be considered a permanent part of this appliance. This manual and all supplied instructions, diagrams, schematics, parts lists, notices, and labels must remain with the appliance if the item is sold or moved to another location.

<b>NOTE</b>	
	For equipment delivered for use in any location regulated by the following directive: <b>DO NOT DISPOSE OF ELECTRICAL OR ELECTRONIC EQUIPMENT WITH OTHER MUNICIPAL WASTE.</b>

# INSTALLATION

## SITE INSTALLATION

The appliance, complete with unattached items and accessories should be checked to ensure all the ordered items have been received.

This Alto-Shaam appliance is designed for the purpose of maintaining hot food at a temperature for safe consumption. The unit must be installed on a level surface in a location that will permit the equipment to function for its intended purpose and allow adequate access for proper cleaning and maintenance.

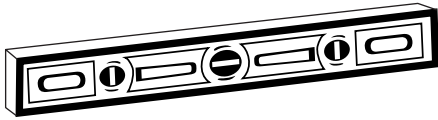

Level the appliance from side-to-side and front-to-back with the use of a spirit level.

**DANGER**  
**IMPROPER INSTALLATION, ALTERATION, ADJUSTMENT, SERVICE OR MAINTENANCE COULD RESULT IN SEVERE INJURY, DEATH OR CAUSE PROPERTY DAMAGE.**

Locate the merchandiser indoors with a normal room temperature of 68-70°F (20-21°C) in an area where it will not be affected by constant cool air current from air conditioners, open doors and windows, etc.

### INSTALLATION REQUIREMENTS

Unit must not be kept in any area where it may be affected by steam, grease, dripping water, high temperatures, or any other severely adverse conditions.

### WEIGHT

	ITM-48	ITM-72
<b>NET</b>	421 lb (191 kg)	677 lb (307 kg)
<b>SHIP</b>	630 lb (286 kg)	845 lb (383 kg)
<b>CRATE</b>	68" x 70" x 52" est. (1729mm x 1778mm x 1321mm)	67" x 93" x 52" (1702mm x 2362mm x 1321mm)
	(H x W x D)	



### CAUTION

**TO PREVENT PERSONAL INJURY, USE CAUTION WHEN MOVING OR LEVELING THIS APPLIANCE.**

# INSTALLATION

## SITE INSTALLATION

### ITM-48

#### OPTIONS & ACCESSORIES

Exterior Base Panels

Custom color	P146
Stainless steel side, 2 REQUIRED	1000428
Stainless steel end, 2 REQUIRED	5000215

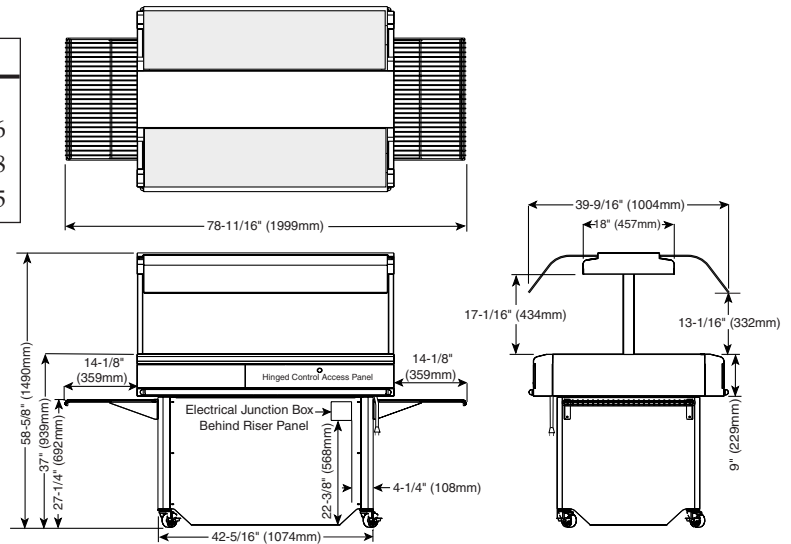

### Exterior Dimensions

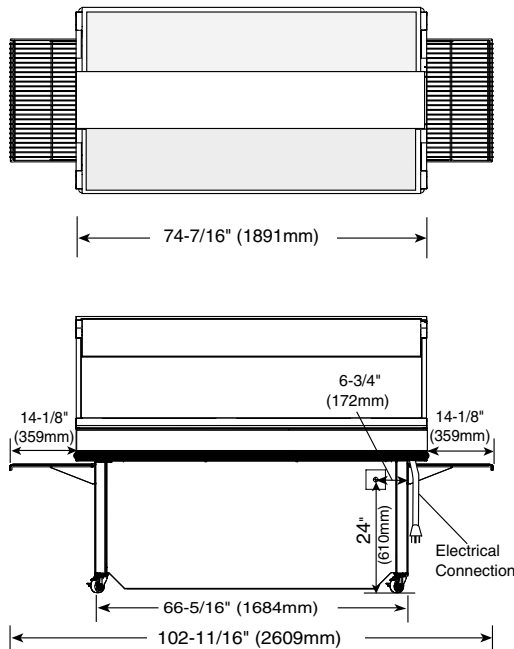

### ITM-72

#### OPTIONS & ACCESSORIES

Exterior Base Panels

Custom color	P147
Stainless steel side, 2 REQUIRED	1000429
Stainless steel end, 2 REQUIRED	5000215

# INSTALLATION

## ELECTRICAL CONNECTION

1. An identification tag is permanently mounted on the unit.

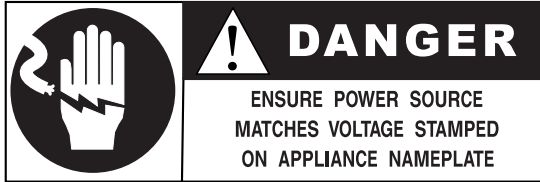

2. If necessary, a proper receptacle or permanent wiring for this unit must be installed by a licensed electrician in accordance with applicable local electrical codes.
3. Plug the unit into a properly grounded receptacle ONLY, positioning the unit so the power supply cord is easily accessible in case of an emergency. Arcing will occur when connecting or disconnecting the unit unless all controls are in the OFF position.



**230V:** To prevent an electrical shock hazard between the appliance and other appliances or metal parts in close vicinity, an equalization-bonding stud is provided. An equalization bonding lead must be connected to this stud and the other appliances / metal parts to provide sufficient protection against potential difference. The terminal is marked with the following symbol. 

**NOTE:** The appliance must be connected to an electrical circuit that is protected by an external GFCI outlet.



ELECTRICAL - ITM-48						
	VOLTAGE	PHASE	CYCLE/HZ	AMPS	kW	CORD & PLUG INCLUDED
120/208-240V	at 208	1	60	17.0	3.5	 NEMA 14-30P 120/250V 30 AMP PLUG
	at 240	1	60	17.6	4.2	
PROVIDED WITH A LOAD CENTER AND CIRCUIT BREAKERS FOR POWER INPUT WITHIN BASE						

ELECTRICAL - ITM-72						
	VOLTAGE	PHASE	CYCLE/HZ	AMPS	kW	CORD & PLUG INCLUDED
120/208-240V	at 208	1	60	25.4	5.3	 NEMA 14-50P 120/250V 50 AMP PLUG
	at 240	1	60	26.3	6.3	
PROVIDED WITH A LOAD CENTER AND CIRCUIT BREAKERS FOR POWER INPUT WITHIN BASE						

# OPERATION

## USER SAFETY INFORMATION

This appliance is intended for use in commercial establishments by qualified personnel who are familiar with the purpose, limitations, and associated hazards of this appliance. Operating instructions and warnings must be read and understood by all operators and users.

	<b>CAUTION</b>
	METAL PARTS OF THIS EQUIPMENT BECOME EXTREMELY HOT WHEN IN OPERATION. TO AVOID BURNS, ALWAYS USE HAND PROTECTION WHEN OPERATING THIS APPLIANCE.

- ✓ Be certain only hot PREPACKAGED foods in appropriate heat tested containers are used in this hot display case.
- ✓ Do not stack food containers.
- ✓ Use hand protection when handling hot items.

	<b>CAUTION</b>
	The performance of this unit has been optimized using the factory provided bulbs. These bulbs should be replaced with an exact replacement or with a factory recommended replacement. These bulbs have been treated to resist breakage and must be replaced with similarly treated bulbs in order to maintain compliance with NSF standards. <b>DO NOT</b> over-tighten bulbs in their receptacles as this can cause damage to the bulb filament.

<b>PRODUCT CAPACITY - ITM-48</b>
42 lbs (20 kg) MAXIMUM
VOLUME MAXIMUM: 26 QUARTS (25 LITERS)
CHICKEN BOATS WITH DOMES - CAPACITY: 12
DOMES PACKAGE SIZE: APPROX. 7" x 10" (178mm x 254mm)

<b>PRODUCT CAPACITY - ITM-72</b>
75 lbs (34 kg) MAXIMUM
VOLUME MAXIMUM: 47 QUARTS (44 LITERS)
CHICKEN PACKAGES WITH DOMES - CAPACITY: 21
DOMES PACKAGE SIZE: APPROX. 7" x 10" (178mm x 254mm)

# OPERATION

## BEFORE INITIAL USE:

Before operating the unit, clean both the interior and exterior of the unit with a damp cloth and mild soap solution. Rinse well.

### 1. Turn the breaker switch "ON".

### 2. Following is the recommended preheat sequence:

- Set lower cable heat thermostat to "9" .
- Set upper calrod heat thermostat to "9".
- Turn the light power switch "ON".
- Turn the lights "ON".

An indicator light will illuminate when the thermostats are turned "ON". The indicators will remain lit as long as the unit is preheating or calling for heat. This unit should be preheated, for a minimum of **45-60 minutes** before loading the case with food. When preheating is completed, the indicator lights will turn off.

Preheat the unit *along with any empty serving pans or containers* which will be used to transfer hot foods for display.

### 3. Load prepackaged hot foods into the merchandiser.

Before loading food into the unit, use a pocket-type meat thermometer to make certain all products have reached an internal temperature of 160° F (71°C) or higher. If any food product is not at proper serving temperature, use a Halo Heat cooking and holding oven or Combitherm Oven to bring the product within the correct temperature range.

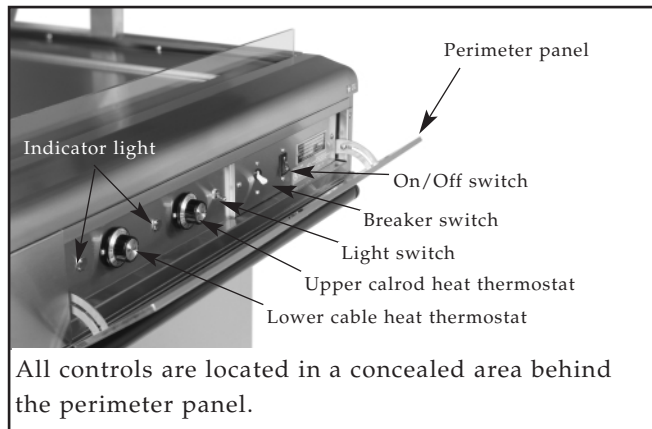

- ✓ Use hand protection when handling hot items.
- ✓ Do not stack food containers.
- ✓ Be certain only hot PREPACKAGED foods in appropriate heat tested containers are used in this hot display case.

### 4. Reset thermostats as needed.

Since proper temperature range depends on the type of products and the quantities being held, it is necessary to periodically use a pocket thermometer to check each item to make certain the correct temperatures are being maintained. Local health regulations may vary regarding minimum serving temperatures. Proper temperature range is usually 160°F (71°C) or higher. Normally, this will require a thermostat setting of "8" although a higher or lower setting may sometimes be required.

# OPERATION

## GENERAL HOLDING GUIDELINES

Chefs, cooks and other specialized food service personnel employ varied methods of cooking. Proper holding temperatures for a specific food product must be based on the moisture content of the product, product density, volume, and proper serving temperatures. Safe holding temperatures must also be correlated with palatability in determining the length of holding time for a specific product.

Halo Heat maintains the maximum amount of product moisture content without the addition of water, water vapor, or steam. Maintaining maximum natural product moisture preserves the natural flavor of the product and provides a more genuine taste. In addition to product moisture retention, the gentle properties of Halo Heat maintain a consistent temperature throughout the cabinet without the necessity of a heat distribution fan, thereby preventing further moisture loss due to evaporation or dehydration.

When product is removed from a high temperature cooking environment for immediate transfer into equipment with the lower temperature required for hot food holding, condensation can form on the outside of the product and on the inside of plastic containers used in self-service applications. Allowing the product to release the initial steam and heat produced by high temperature cooking can alleviate this condition. To preserve the safety and quality of freshly cooked foods however, a maximum of 1 to 2 minutes must be the only time period allowed for the initial heat to be released from the product.

Use a metal-stemmed thermometer to measure the internal temperature of the product being held. Adjust the thermostat setting to achieve the best overall setting based on internal product temperature.

HOLDING TEMPERATURE RANGE		
	FAHRENHEIT	CELSIUS
<b>MEAT</b>		
BEEF ROAST — Rare	140°F	60°C
BEEF ROAST — Med/Well Done	160°F	71°C
BEEF BRISKET	160° — 175°F	71° — 79°C
CORN BEEF	160° — 175°F	71° — 79°C
PASTRAMI	160° — 175°F	71° — 79°C
PRIME RIB — Rare	140°F	60°C
STEAKS — Broiled/Fried	140° — 160°F	60° — 71°C
RIBS — Beef or Pork	160°F	71°C
VEAL	160° — 175°F	71° — 79°C
HAM	160° — 175°F	71° — 79°C
PORK	160° — 175°F	71° — 79°C
LAMB	160° — 175°F	71° — 79°C
<b>POULTRY</b>		
CHICKEN — Fried/Baked	160° — 175°F	71° — 79°C
DUCK	160° — 175°F	71° — 79°C
TURKEY	160° — 175°F	71° — 79°C
GENERAL	160° — 175°F	71° — 79°C
<b>FISH/SEAFOOD</b>		
FISH — Baked/Fried	160° — 175°F	71° — 79°C
LOBSTER	160° — 175°F	71° — 79°C
SHRIMP — Fried	160° — 175°F	71° — 79°C
<b>BAKED GOODS</b>		
BREADS/ROLLS	120° — 140°F	49° — 60°C
<b>MISCELLANEOUS</b>		
CASSEROLES	160° — 175°F	71° — 79°C
DOUGH — Proofing	80° — 100°F	27° — 38°C
EGGS — Fried	150° — 160°F	66° — 71°C
FROZEN ENTREES	160° — 175°F	71° — 79°C
HORS D'OEUVRES	160° — 180°F	71° — 82°C
PASTA	160° — 180°F	71° — 82°C
PIZZA	160° — 180°F	71° — 82°C
POTATOES	180°F	82°C
PLATED MEALS	180°F	82°C
SAUCES	140° — 200°F	60° — 93°C
SOUP	140° — 200°F	60° — 93°C
VEGETABLES	160° — 175°F	71° — 79°C
The holding temperatures listed are suggested guidelines only.		

# CARE and CLEANING

## CLEANING AND PREVENTIVE MAINTENANCE

### PROTECTING STAINLESS STEEL SURFACES



It is important to guard against corrosion in the care of stainless steel surfaces. Harsh, corrosive, or inappropriate chemicals can completely destroy the

protective surface layer of stainless steel. Abrasive pads, steel wool, or metal implements will abrade surfaces causing damage to this protective coating and will eventually result in areas of corrosion. Even water, particularly hard water that contains high to moderate concentrations of chloride, will cause oxidation and pitting that result in rust and corrosion. In addition, many acidic foods spilled and left to remain on metal surfaces are contributing factors that will corrode surfaces.

Proper cleaning agents, materials, and methods are vital to maintaining the appearance and life of this appliance. Spilled foods should be removed and the area wiped as soon as possible but at the very least, a minimum of once a day. Always thoroughly rinse surfaces after using a cleaning agent and wipe standing water as quickly as possible after rinsing.

### CLEANING AGENTS

Use non-abrasive cleaning products designed for use on stainless steel surfaces. Cleaning agents must be chloride-free compounds and must not contain quaternary salts. Never use hydrochloric acid (muriatic acid) on stainless steel surfaces. Always use the proper cleaning agent at the manufacturer's recommended strength. Contact your local cleaning supplier for product recommendations.

### CLEANING MATERIALS

The cleaning function can usually be accomplished with the proper cleaning agent and a soft, clean cloth. When more aggressive methods must be employed, use a non-abrasive scouring pad on difficult areas and make certain to scrub with the visible grain of surface metal to avoid surface scratches. Never use wire brushes, metal scouring pads, or scrapers to remove food residue.

	<p><b>CAUTION</b></p> <p><b>TO PROTECT STAINLESS STEEL SURFACES, COMPLETELY AVOID THE USE OF ABRASIVE CLEANING COMPOUNDS, CHLORIDE BASED CLEANERS, OR CLEANERS CONTAINING QUATERNARY SALTS. NEVER USE HYDROCHLORIC ACID (MURIATIC ACID) ON STAINLESS STEEL. NEVER USE WIRE BRUSHES, METAL SCOURING PADS OR SCRAPERS.</b></p>
--	--

## CARE and CLEANING

The cleanliness and appearance of this equipment will contribute considerably to operating efficiency and savory, appetizing food. Good equipment that is kept clean works better and lasts longer.



### THOROUGHLY CLEAN THE APPLIANCE DAILY

1. Turn lights and adjustable thermostat(s) to the "OFF" position. Disconnect unit from power source by turning breaker switch to the "OFF" position. Let the unit cool.
2. Remove, cover or wrap, and refrigerate food.
3. Clean interior metal surfaces of the unit with a damp, clean cloth and any good commercial detergent or grease solvent at the recommended strength. Use a plastic scouring pad or oven cleaner for difficult areas. Rinse carefully to remove all residue and wipe dry.



**NOTE:** Avoid the use of abrasive cleaning, compounds, chloride based cleaners, or cleaners containing quaternary salts. Never use hydrochloric acid (muriatic acid) on stainless steel.

4. Wipe control panel, any vents, handles, and gaskets thoroughly since these areas harbor food debris.
5. Interior can be wiped with a sanitizing solution after cleaning and rinsing. This solution must be approved for use on stainless steel food contact surfaces.
6. Clean glass and heat guard with a window cleaner.
7. To help maintain the protective film coating on polished stainless steel, clean the exterior of the unit with a cleaner recommended for stainless steel surfaces. Spray the cleaning agent on a cloth and wipe with the grain of the stainless steel.

Always follow appropriate state or local health (hygiene) regulations regarding all applicable cleaning and sanitation requirements for foodservice equipment.

Remember to turn the breaker switch ON again before operating the unit.



# SANITATION

Food flavor and aroma are usually so closely related that it is difficult, if not impossible, to separate them. There is also an important, inseparable relationship between cleanliness and food flavor. Cleanliness, top operating efficiency, and appearance of equipment contribute considerably to savory, appetizing foods. Good equipment that is kept clean, works better and lasts longer.

Most food imparts its own particular aroma and many foods also absorb existing odors. Unfortunately, during this absorption, there is no distinction between GOOD and BAD odors. The majority of objectionable flavors and odors troubling food service operations are caused by bacteria growth. Sourness, rancidity, mustiness, stale or other OFF flavors are usually the result of germ activity.

The easiest way to insure full, natural food flavor is through comprehensive cleanliness. This means good control of both visible soil (dirt) and invisible soil (germs). A thorough approach to sanitation will provide essential cleanliness. It will assure an attractive appearance of equipment, along with maximum efficiency and utility. More importantly, a good sanitation program provides one of the key elements in the prevention of food-borne illnesses.

A controlled holding environment for prepared foods is just one of the important factors involved in the prevention of food-borne illnesses. Temperature monitoring and control during receiving, storage, preparation, and the service of foods are of equal importance.

The most accurate method of measuring safe temperatures of both hot and cold foods is by internal product temperature. A quality thermometer is an effective tool for this purpose, and should be routinely used on all products that require holding at a specific temperature.

A comprehensive sanitation program should focus on the training of staff in basic sanitation procedures. This includes personal hygiene, proper handling of raw foods, cooking to a safe internal product temperature, and the routine monitoring of internal temperatures from receiving through service.

Most food-borne illnesses can be prevented through proper temperature control and a comprehensive program of sanitation. Both these factors are important to build quality service as the foundation of customer satisfaction. Safe food handling practices to prevent food-borne illness is of critical importance to the health and safety of your customers. HACCP, an acronym for Hazard Analysis (at) Critical Control Points, is a quality control program of operating procedures to assure food integrity, quality, and safety. Taking steps necessary to augment food safety practices are both cost effective and relatively simple. While HACCP guidelines go far beyond the scope of this manual, additional information is available by contacting:

**Center for Food Safety and Applied Nutrition  
Food and Drug Administration  
1-888-SAFEFOOD**

INTERNAL FOOD PRODUCT TEMPERATURES		
<b>HOT FOODS</b>		
DANGER ZONE	40° TO 140°F	(4° TO 60°C)
CRITICAL ZONE	70° TO 120°F	(21° TO 49°C)
SAFE ZONE	140° TO 165°F	(60° TO 74°C)
<b>COLD FOODS</b>		
DANGER ZONE	ABOVE 40°F	(ABOVE 4°C)
SAFE ZONE	36°F TO 40°F	(2°C TO 4°C)
<b>FROZEN FOODS</b>		
DANGER ZONE	ABOVE 32°F	(ABOVE 0°C)
CRITICAL ZONE	0° TO 32°F	(-18° TO 0°C)
SAFE ZONE	0°F OR BELOW	(-18°C OR BELOW)

## SERVICE

	Description	ITM-48	Qty.	ITM-72	Qty.
1	Bulb, 60W, 130V, coated	LP-33598	6	LP-33598	8
2	Bulb Receptacle	RP-3955	6	RP-3955	8
3	Cord Set, electric, NOT SHOWN	CD-33672	1	CD-33673	1
4	Block, 4 terminal, NOT SHOWN	BK-3023	1	BK-3023	1
5	Circuit Breaker, Switch, 15 Amp	SW-33342	1	SW-33342	1
6	Circuit Breaker, Switch, 30 Amp	SW-3715	1	SW-3715	1
7	Light Switch, toggle, 6 Amp, 125V	SW-3041	1	SW-3041	1
8	Block, 2 terminal, Sensor, NOT SHOWN	BK-33546	1	BK-33546	1
9	Block, modular assembly	BK-33364	1	BK-33364	1
10	Thermostat, Upper heat	TT-33461	1	TT-33461	1
11	Thermostat, Lower heat	TT-3498	1	TT-3498	1
12	Light Indicator	LI-3025	2	LI-3025	2
13	Cable, Heating	CB-3045	127 ft. (38.70m)	CB-3045	195 ft. (59.44)
14	Extrusion, Bumper	1000230	2	1000209	2
15	Bumper, black vinyl, extrusion	BM-24082	8 ft. (2.44m)	BM-24082	12 ft. (3.66m)
16	Bumper, rail end cap, black vinyl	BM-24083	4	BM-24083	4
17	Clamp, glass	CM-26985	2	CM-26986	2
18	Bumper to protect glass sneeze-guard	DR-2533	4	DR-2533	4
19	Guard, Heat	GD-24852	4	GD-24853	4
	End Heat Guard, NOT SHOWN	16370	2	16370	2
	End Heat Guard Spacer, NOT SHOWN	SP-25365	4	SP-25365	4
20	Guard, thermostat capillary	GD-2536	1	GD-2536	1
21	Element, Calrod, heating, 208V	EL-33866	2	EL-33869	2
	Element, Calrod, heating, 240V	EL-33868	2	EL-33870	2
22	Heat Guard Cover for Calrod Element, NOT SHOWN	5002055	2	5002056	2
23	Knob, Thermostat	KN-3473	2	KN-3473	2
24	Caster, 3" (76mm) swivel w/brake	CS-24351	4	CS-24351	4
25	Glass, sneeze-guard	GL-22593	2	GL-22594	2
26	Gasket	GS-22547	6 ft. (1.82m)	GS-22547	6 ft. (1.82m)
27	Insulation, NOT SHOWN	IN-2003	4	IN-2003	4
28	Insulation, NOT SHOWN	IN-22364	2	IN-22364	2
29	Shelf, side, grid	SH-2114	2	SH-2114	2
30	Shelf bracket, LH	1000171	2	1000171	2
31	Shelf bracket, RH	1000172	2	1000172	2
32	Control side trim	5000097	1	5000089	1
33	Customer trim	5000096	1	5000088	1
34	Control door panel	5000087	2	5000087	2
35	End Panel base	55239	2	55239	2
36	Front & Rear Panel base	OP26656	2	1000169	2
37	Pan insert, shallow	5000182	1	5000181	1
	Guard mount, NOT SHOWN	1000440	2	1000438	2

*See service views on following pages.*

# SERVICE

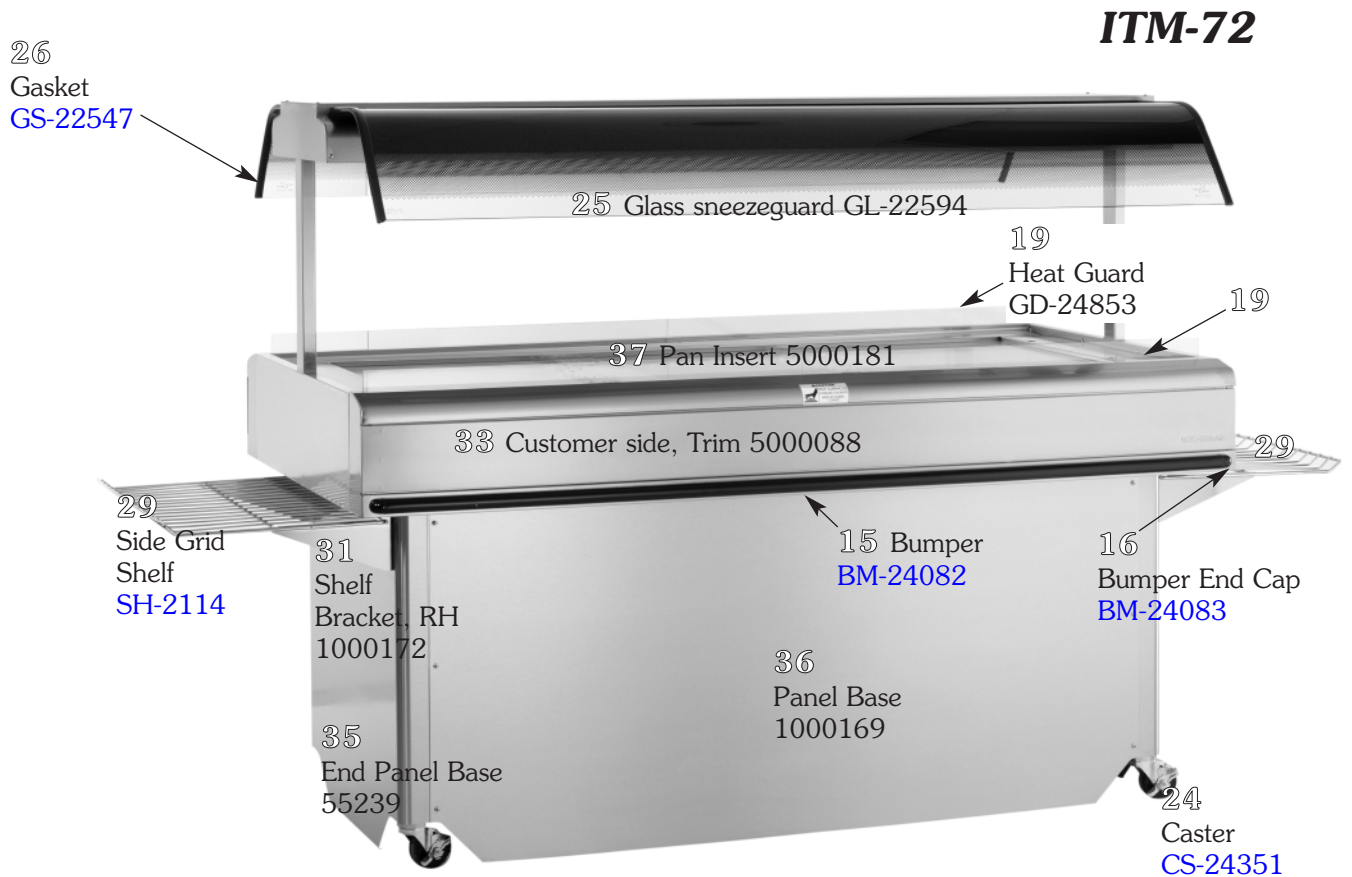
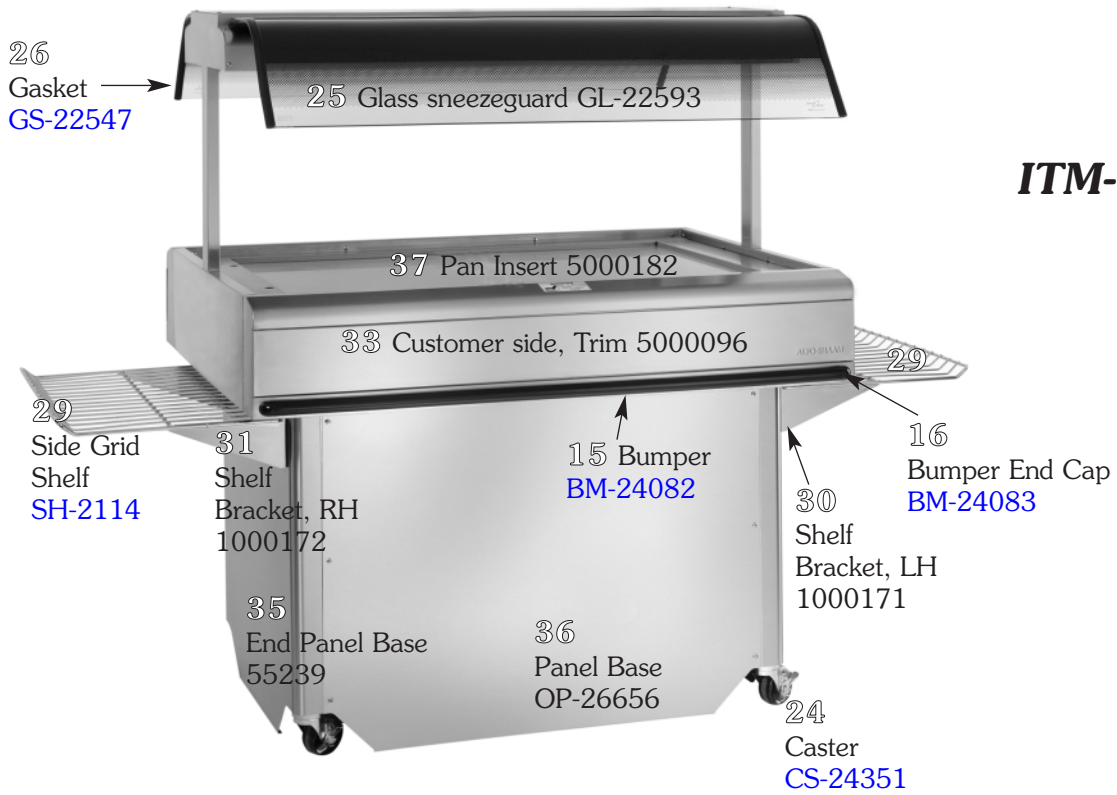

## SERVICE

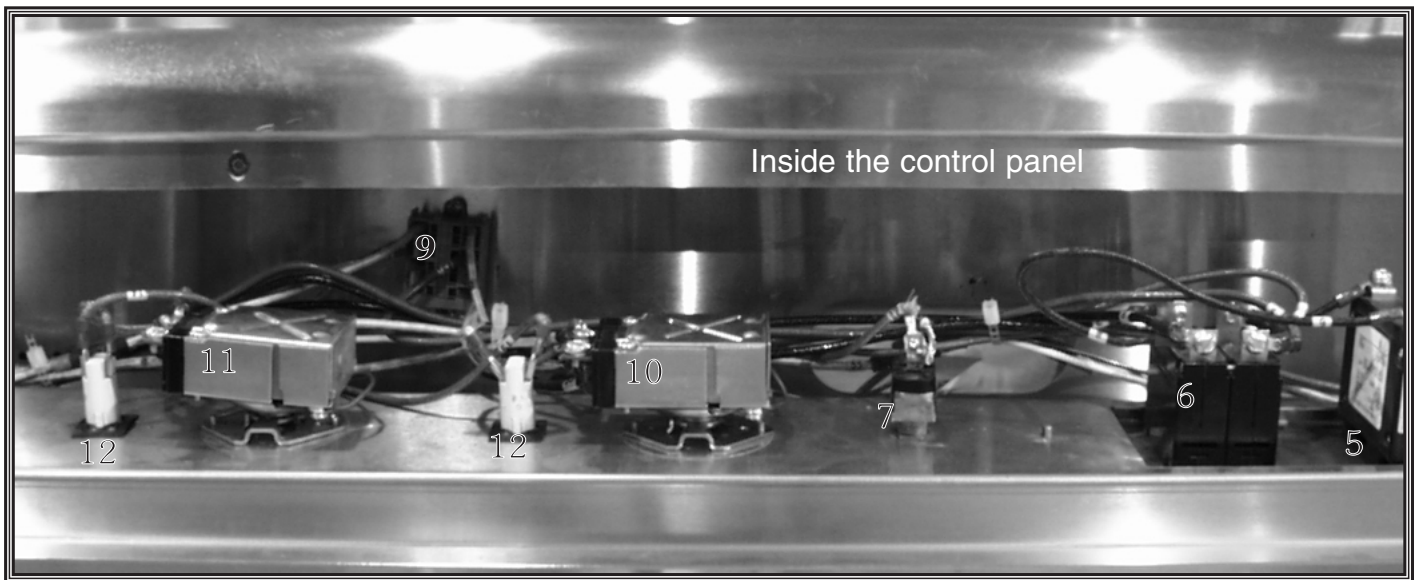
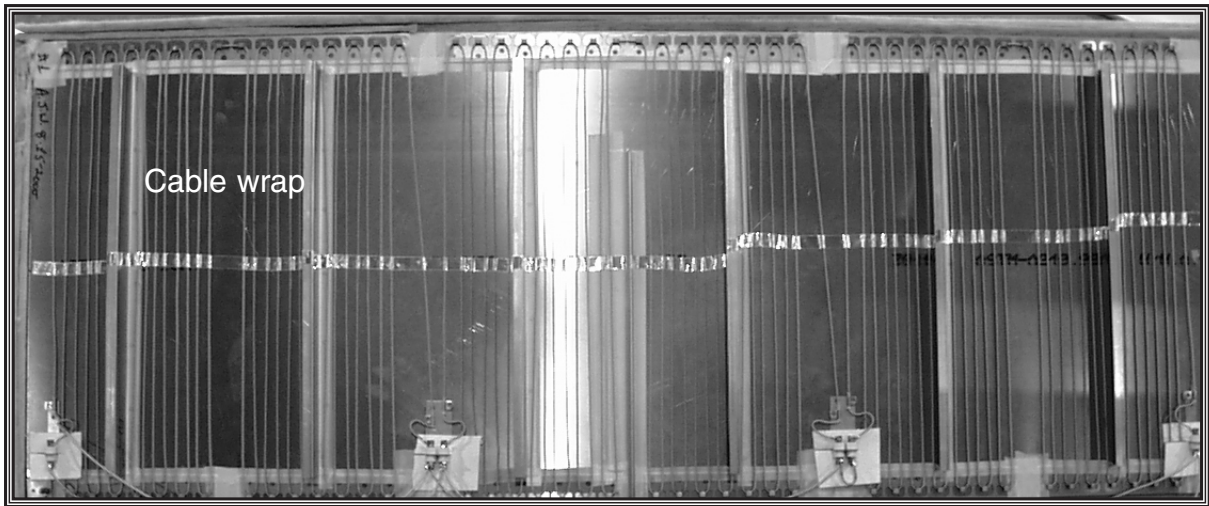

- |    |                              |          |
|----|------------------------------|----------|
| 5  | Circuit Breaker, 15 Amp      | SW-33342 |
|    | ON/OFF Light Switch          | SW-3715  |
| 6  | Circuit Breaker, 30 Amp      | SW-3041  |
| 7  | Light Toggle Switch,         | BK-33364 |
| 9  | Block, modular assembly      | TT-33461 |
| 10 | Upper Heat Calrod Thermostat | TT-3498  |
| 11 | Lower Heat Cable Thermostat  | LI-3025  |
| 12 | Indicator Light              | CB-3045  |
| 13 | Cable, Heating               |          |

# SERVICE



Heated well can be lifted for servicing cable heating element.

## Assembled Well #55654

### ITM - 48

Cable Heating Service Kit . . . . . No. 4880

includes:

<b>CB-3045</b>	Cable Heating Element . . . . .	134 feet
<b>CR-3226</b>	Ring Connector . . . . .	4
<b>IN-3488</b>	Insulation Corner . . . . .	1 foot
<b>BU-3105</b>	Shoulder Bushing . . . . .	4
<b>BU-3106</b>	Cup Bushing . . . . .	4
<b>SL-3063</b>	Insulating Sleeve . . . . .	4
<b>TA-3540</b>	Electrical tape . . . . .	1 roll
<b>ST-2439</b>	Stud, 10-32 . . . . .	4
<b>NU-2215</b>	Hex Nut, 10-32 . . . . .	8

## Assembled Well #55655

### ITM-72

Cable Heating Service Kit . . . . . 4881

includes:

<b>CB-3045</b>	Cable Heating Element . . . . .	210 feet
<b>CR-3226</b>	Ring Connector . . . . .	12
<b>IN-3488</b>	Insulation Corner . . . . .	1 foot
<b>BU-3105</b>	Shoulder Bushing . . . . .	12
<b>BU-3106</b>	Cup Bushing . . . . .	12
<b>SL-3063</b>	Insulating Sleeve . . . . .	12
<b>TA-3540</b>	Electrical Tape . . . . .	1 roll
<b>ST-2439</b>	Stud, 10-32 . . . . .	12
<b>NU-2215</b>	Hex Nut, 10-32 . . . . .	24

## SERVICE



- 17 Glass Clamp  
CM-26985 or CM-26986
- 18 Bumper to protect glass  
[DR-2533](#)

- 1 Bulb  
[LP-33598](#)
- 2 Bulb Receptacle  
[RP-3955](#)
- 20 Guard, thermostat capillary  
[GD-2536](#)
- 21 Calrod heating element  
EL-33966 or EL-33869,  
208V  
EL-33868 or EL-33870,  
240V

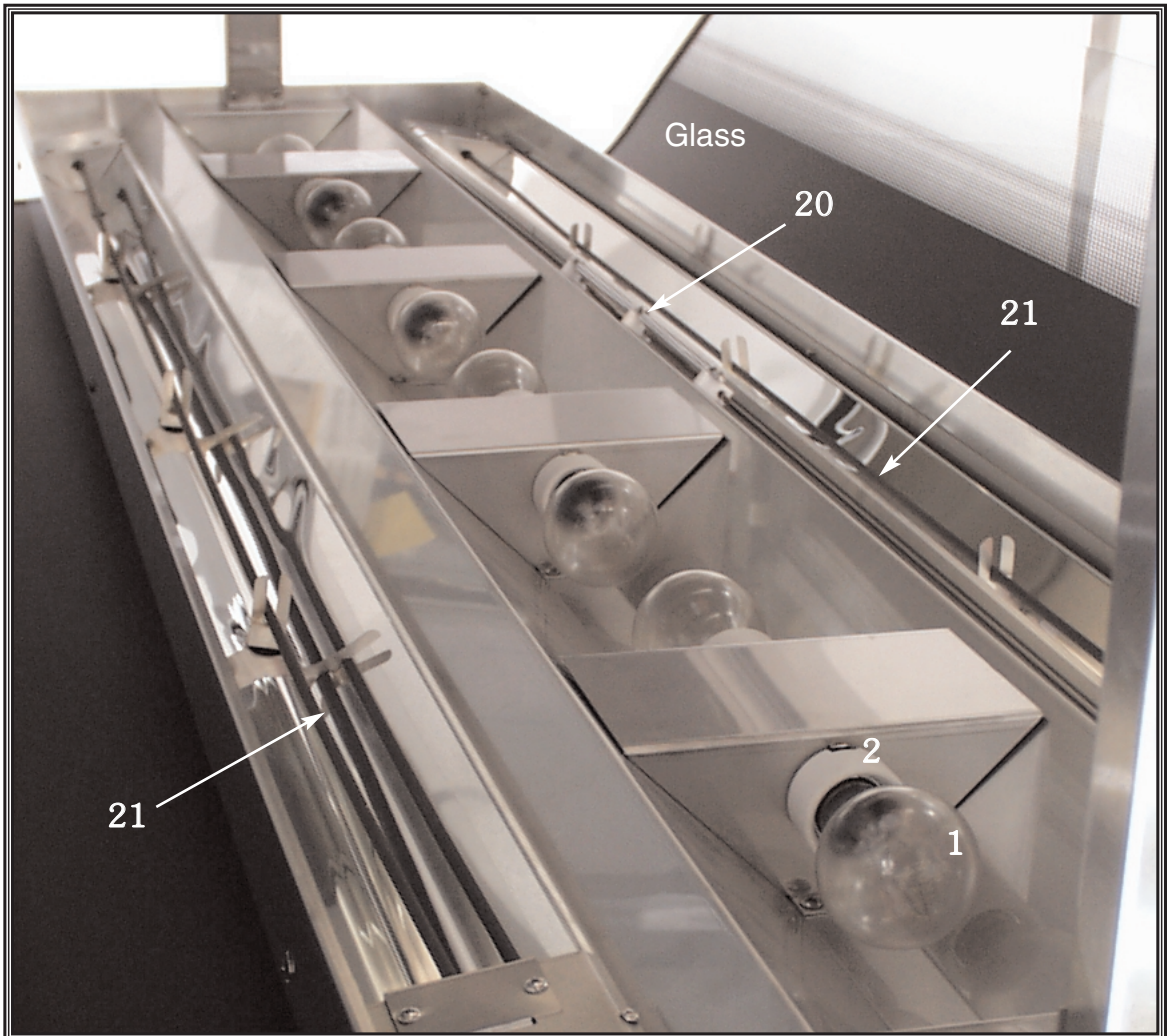

UPPER CALROD HEATING ELEMENT  
 (EL-33866) 590W @ 208V, 2.8 AMPS (2 REQUIRED)  
 -OR-  
 (EL-33868) 590W @ 240V, 2.5 AMPS (2 REQUIRED)

UPPER CALROD  
 HTG ELEMENT #1

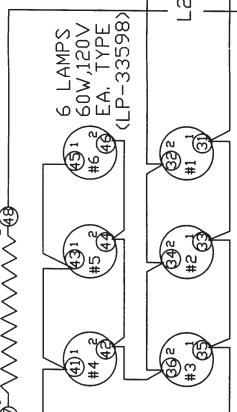

CERAMIC  
 T-BLOCK  
 (BL-33546)



TOTAL POWER

3536W @ 120/208V, 17.0 AMPS, 60HZ  
 4228W @ 120/240V, 17.6 AMPS, 60HZ

HI TEMP HEATING CABLE  
 (CB-3045)  
 EA. CABLE = 63.5 FT., 43 OHMS  
 998W @ 208V, 4.8 AMPS  
 -OR-  
 1344W @ 240V, 5.6 AMPS  
 (2 REQUIRED)

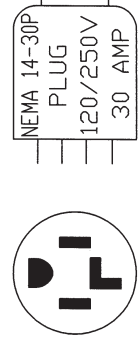
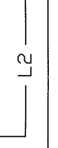
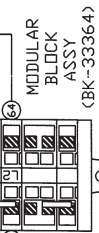
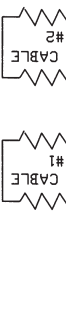

WIRING DIAGRAM  
 MODELS TH-48  
 120V/208-240V  
**AUTOSHAM**  
 AUTOMATIC SHAMING SYSTEMS  
 11/06/02  
 NO. REVISION 1  
 BY: NAW SCALE: 1/2"=1'-0"  
 APP. JSH DATE: 06/13/00 B-7576

SEE DRW #B-8005 FOR WIRING ASSEMBLY DRAWING.



## TRANSPORTATION DAMAGE and CLAIMS



All Alto-Shaam equipment is sold F.O.B. shipping point, and when accepted by the carrier, such shipments become the property of the consignee.

Should damage occur in shipment, it is a matter between the carrier and the consignee. In such cases, the carrier is assumed to be responsible for the safe delivery of the merchandise, unless negligence can be established on the part of the shipper.

1. Make an immediate inspection while the equipment is still in the truck or immediately after it is moved to the receiving area. Do not wait until after the material is moved to a storage area.
2. Do not sign a delivery receipt or a freight bill until you have made a proper count and inspection of all merchandise received.
3. Note all damage to packages directly on the carrier's delivery receipt.
4. Make certain the driver signs this receipt. If he refuses to sign, make a notation of this refusal on the receipt.
5. If the driver refuses to allow inspection, write the following on the delivery receipt:  
*Driver refuses to allow inspection of containers for visible damage.*
6. Telephone the carrier's office immediately upon finding damage, and request an inspection. Mail a written confirmation of the time, date, and the person called.
7. Save any packages and packing material for further inspection by the carrier.
8. Promptly file a written claim with the carrier and attach copies of all supporting paperwork.

We will continue our policy of assisting our customers in collecting claims which have been properly filed and actively pursued. We cannot, however, file any damage claims for you, assume the responsibility of any claims, or accept deductions in payment for such claims.

## ALTO SHAAM. LIMITED WARRANTY

Alto-Shaam, Inc. warrants to the original purchaser that any original part that is found to be defective in material or workmanship will, at Alto-Shaam's option, subject to provisions hereinafter stated, be replaced with a new or rebuilt part.

The labor warranty remains in effect one (1) year from installation or fifteen (15) months from the shipping date, whichever occurs first. Alto-Shaam will bear normal labor charges performed during standard business hours, and excluding overtime, holiday rates or any additional fees.

The parts warranty remains in effect for one (1) year from installation or fifteen (15) months from the shipping date, whichever occurs first.

However, the heating element on Halo Heat® cook/hold ovens and the refrigeration compressor on Alto-Shaam Quickchillers™ are warranted for a period of five (5) years from installation. The labor warranty is the same as stated above; namely, for one (1) year from installation or fifteen (15) months from the shipping date, whichever occurs first.

### THIS WARRANTY DOES NOT APPLY TO:

1. Calibration.
2. Replacement of light bulbs and/or the replacement of display case glass due to damage of any kind.
3. Equipment damage caused by accident, shipping, improper installation or alteration.
4. Equipment used under conditions of abuse, misuse, carelessness or abnormal conditions including, but not limited to, equipment subjected to harsh or inappropriate chemicals including, but not limited to, compounds containing chloride or quaternary salts, poor water quality, or equipment with missing or altered serial numbers.
5. Damage incurred as a direct result of poor water quality, inadequate maintenance of steam generators and/or surfaces affected by water quality. Water quality and required maintenance of steam generating equipment is the responsibility of the owner/operator.
6. Damage caused by use of any cleaning agent other than Alto-Shaam's Combitherm® Cleaner including, but not limited to, damage due to chlorine or other harmful chemicals. Use of Alto-Shaam's Combitherm® Cleaner on Combitherm® ovens is highly recommended.
7. Any losses or damage resulting from malfunction, including loss of product or consequential or incidental damages of any kind.
8. Equipment modified in any manner from original model, substitution of parts other than factory authorized parts, removal of any parts including legs, or addition of any parts.

This warranty is exclusive and is in lieu of all other warranties, expressed or implied, including the implied warranties of merchantability and fitness for a particular purpose. In no event shall Alto-Shaam be liable for loss of use, loss of revenue or profit, or loss of product, or for any indirect or consequential damages. No person except an officer of Alto-Shaam, Inc. is authorized to modify this warranty or to incur on behalf of Alto-Shaam any other obligation or liability in connection with Alto-Shaam equipment.

**ALTO-SHAAM, INC.**

RECORD THE MODEL AND SERIAL NUMBER OF THE APPLIANCE FOR EASY REFERENCE.  
ALWAYS REFER TO BOTH MODEL AND SERIAL NUMBER IN ANY CONTACT WITH ALTO-SHAAM REGARDING THIS APPLIANCE.

Model: \_\_\_\_\_ Date Installed: \_\_\_\_\_  
Voltage: \_\_\_\_\_ Purchased From: \_\_\_\_\_  
Serial Number: \_\_\_\_\_

**W164 N9221 Water Street • P.O. Box 450 • Menomonee Falls, Wisconsin 53052-0450 • U.S.A.**  
PHONE: 262.251.3800 • 800.558-8744 USA/CANADA FAX: 262.251.7067 • 800.329.8744 U.S.A. ONLY  
WEBSITE: [www.alto-shaam.com](http://www.alto-shaam.com)

PRINTED IN U.S.A.