

**ALTO SHAAM®**

**Hot Food Shelf  
Electric**

**Model:  
300-HST**

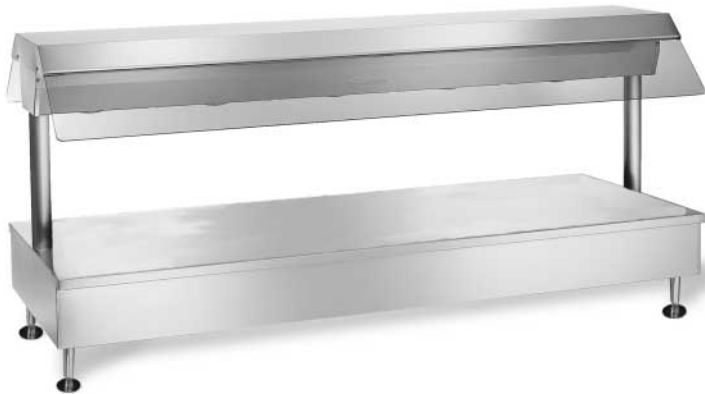

- **INSTALLATION**
- **OPERATION**
- **MAINTENANCE**

**HALO  
HEAT®**

**24•7**  
Your Service Hotline  
1-800-558-8744

**W164 N9221 Water Street • P.O. Box 450 • Menomonee Falls, Wisconsin 53052-0450 USA**  
PHONE: 262.251.3800 • 800.558.8744 USA/CANADA FAX: 262.251.7067 • 800.329.8744 U.S.A. ONLY  
WEBSITE: [www.alto-shaam.com](http://www.alto-shaam.com)

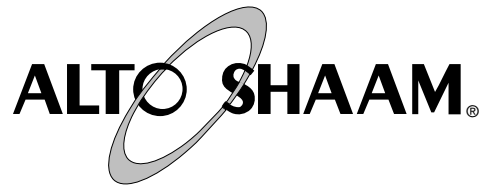

## DELIVERY

This Alto-Shaam appliance has been thoroughly tested and inspected to insure only the highest quality unit is provided. Upon receipt, check for any possible shipping damage and report it at once to the delivering carrier. *See Transportation Damage and Claims section located in this manual.*

This appliance, complete with unattached items and accessories, may have been delivered in one or more packages. Check to ensure that all standard items and options have been received with each model as ordered.

Save all the information and instructions packed with the appliance. Complete and return the warranty card to the factory as soon as possible to assure prompt service in the event of a warranty parts and labor claim.

This manual must be read and understood by all people using or installing the equipment model. Contact the Alto-Shaam service department if you have any questions concerning installation, operation, or maintenance.

**NOTE:** All claims for warranty must include the full model number and serial number of the unit.

## UNPACKING

1. Carefully remove the appliance from the carton or crate.

**NOTE:** Do not discard the carton and other packaging material until you have inspected the unit for hidden damage and tested it for proper operation.

2. Read all instructions in this manual carefully before initiating the installation of this appliance.

**DO NOT DISCARD THIS MANUAL.**

This manual is considered to be part of the appliance and is to be provided to the owner or manager of the business or to the person responsible for training operators. *Additional manuals are available from the Alto-Shaam service department.*

3. Remove all protective plastic film, packaging materials, and accessories from the appliance before connecting electrical power. Store any accessories in a convenient place for future use.

## SAFETY PROCEDURES AND PRECAUTIONS

Knowledge of proper procedures is essential to the safe operation of electrically and/or gas energized equipment. In accordance with generally accepted product safety labeling guidelines for potential hazards, the following signal words and symbols may be used throughout this manual.

### **DANGER**

Used to indicate the presence of a hazard that **will** cause severe personal injury, death, or substantial property damage if the warning included with this symbol is ignored.

### **WARNING**

Used to indicate the presence of a hazard that **can** cause personal injury, possible death, or major property damage if the warning included with this symbol is ignored.

### **CAUTION**

Used to indicate the presence of a hazard that can or will cause minor or moderate personal injury or property damage if the warning included with this symbol is ignored.

### **CAUTION**

Used to indicate the presence of a hazard that can or will cause minor personal injury, property damage, or a potential unsafe practice if the warning included with this symbol is ignored.

### **NOTE:**

Used to notify personnel of installation, operation, or maintenance information that is important but not hazard related.

1. This appliance is intended to cook, hold or process foods for the purpose of human consumption. No other use for this appliance is authorized or recommended.
2. This appliance is intended for use in commercial establishments where all operators are familiar with the purpose, limitations, and associated hazards of this appliance. Operating instructions and warnings must be read and understood by all operators and users.
3. Any troubleshooting guides, component views, and parts lists included in this manual are for general reference only and are intended for use by qualified technical personnel.
4. This manual should be considered a permanent part of this appliance. This manual and all supplied instructions, diagrams, schematics, parts lists, notices, and labels must remain with the appliance if the item is sold or moved to another location.

# INSTALLATION

## Site Installation

This appliance,, complete with unattached items and accessories, may be delivered in one or more packages. Check to insure that all the following items have been received as standard with each unit:

6: 6" (152 mm) legs

10: bulbs

Alto-Shaam hot shelves are designed for the purpose of maintaining hot food at a temperature for safe consumption. The unit must be installed on a level surface in a location that will permit the equipment to function for its intended purpose and allow adequate access for proper cleaning and maintenance.

The appliance must not be installed in any area where it will be affected by steam, grease, dripping water, high temperatures, or any other severely adverse conditions.

In order to maintain standards established by the National Sanitation Foundation, all stationary counter-mounted equipment must be secured flush to the counter and the entire base sealed to the counter with NSF approved sealant or equipped with 4" (102mm) legs to provide minimum unobstructed space beneath the unit. These legs are supplied with the unit. Warranty will become null and void if these directions are not followed.

Level the appliance from side-to-side and back-to-back with the use of a spirit level.

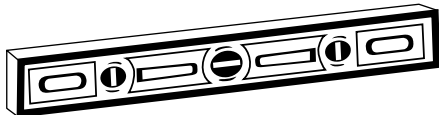

NET WEIGHT
116 lb. (53 kg)



# INSTALLATION

## Site Installation

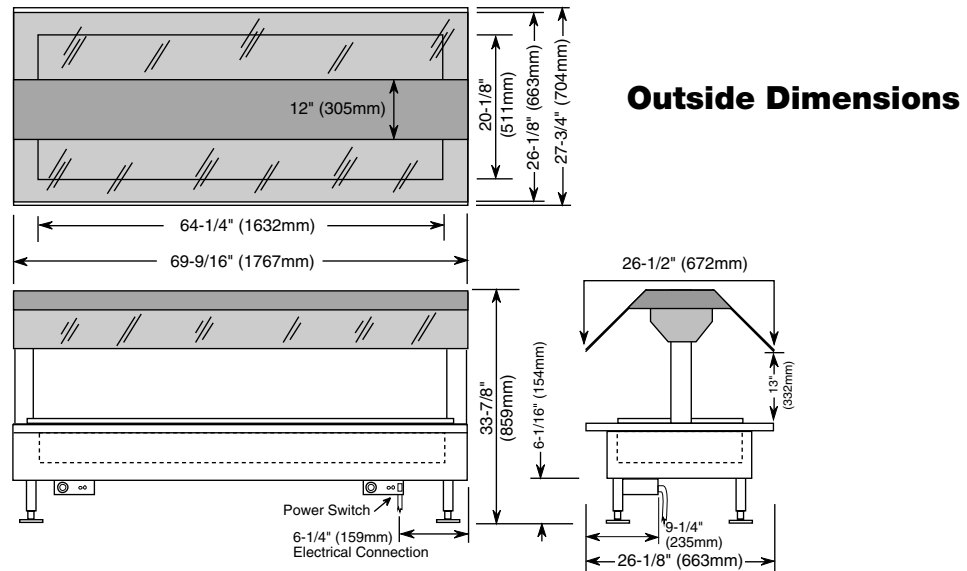

### Options and Accessories

Options and Accessories	CONTACT FACTORY
Custom Panel Colors	
Customer Sneeze Guard	
➤ Front Guard	44149
➤ End Guard	44239
Decorator Carts, Mobile	
◆ Enclosed on three sides, 2 shelves	55181
➤ Painted Decor Panel Package	44073
➤ Stainless Steel Decor Panel Package	44076
◆ Enclosed on three sides, open	55182
➤ Painted Decor Panel Package	44073
➤ Stainless Steel Decor Panel Package	44076
◆ Fully enclosed	55183
➤ Painted Decor Panel Package	44074
➤ Stainless Steel Decor Panel Package	44077

This 300-HST hot food shelf is designed to fit directly on top of an Alto-Shaam decorator cart. This cart is available in three styles.

Fully enclosed on three sides with shelves.



Fully enclosed on three sides without shelves.



Fully enclosed on all four sides.

### Cart Dimensions

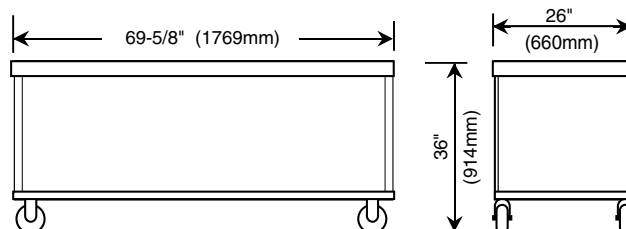

# INSTALLATION

## Electrical Installation

1. An identification tag is permanently mounted on the case.

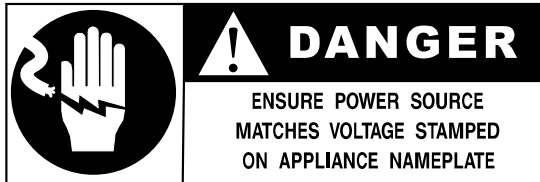
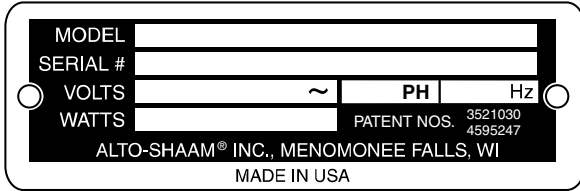





### 230V:

To prevent an electrical shock hazard between the appliance and other appliances or metal parts in close vicinity, an equalization-bonding stud is provided. An equalization bonding lead must be connected to this stud and the other appliances / metal parts to provide sufficient protection against potential difference. The terminal is marked with the following symbol. 

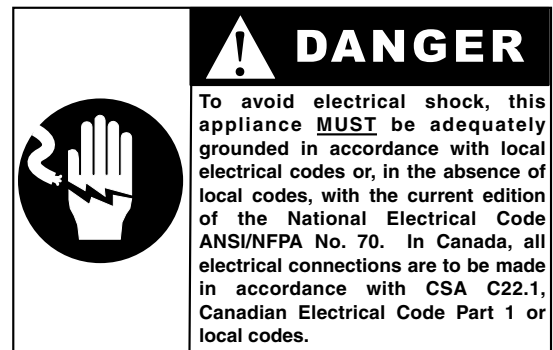
**NOTE:** The appliance must be connected to an electrical circuit that is protected by an external GFCI outlet.

2. Plug the unit into a properly grounded receptacle ONLY. Arcing will occur when connecting or disconnecting the unit unless all controls are in the "OFF" position.
3. Position the unit so the cord is easily accessible in case of any emergencies. If necessary, a proper receptacle or outlet configuration, as required for the unit, must be installed by a licensed electrician in accordance with applicable, local electrical codes.



ELECTRICAL					
	VOLTAGE	PHASE	CYCLE/HZ	AMPS	kW
	120	1	60	27.1	3.3
					 NEMA L5-30P 30A-125V PLUG
208-240	at 208	1	50/60	12.5	2.6
	at 240	1	50/60	13.4	3.2
					 NEMA L6-20P 20A-250V PLUG
	230	1	50	14.1	3.2
					 NEMA CEE7/7 16A-250V PLUG

# OPERATION

## User Safety Information

This appliance is intended for use in commercial establishments by qualified personnel who are familiar with the purpose, limitations, and associated hazards of this appliance. Operating instructions and warnings must be read and understood by all operators and users.

### BEFORE INITIAL USE:

Clean the metal surface exterior of the appliance with a clean, damp cloth and mild soap solution. Rinse carefully.

### NOTE:

Clean the acrylic sneeze guard with soap or mild detergent and water. Dry with a clean, damp chamois. Grease and oil may be removed with naphtha or hexane. Do not use commercial or household cleaners containing ammonia. To avoid scratching, do not use dry cloths or scouring compounds.

### CAPACITY

60 lbs (27 kg) MAXIMUM  
VOLUME MAXIMUM: 37.5 QUARTS (35.5 LITERS)

### 1. TURN DISPLAY LIGHTS "ON" AND PREHEAT THE SHELF BY SETTING THE ADJUSTABLE THERMOSTAT TO THE NUMBER "10" SETTING.

An indicator light will illuminate when the unit is turned "ON". This indicator will remain lit as long as the unit is preheating or calling for heat. The unit should be preheated, at the number 10 setting, for a minimum of twenty minutes before loading the table with food. When preheating is completed, or whenever the unit reaches any temperature set by the operator between 1 and 10, the indicator light will go "OUT".

### 2. PLACE HOT FOODS ON THE SHELF

Be certain only hot food is transferred into the hot food table. Before loading food onto the shelf, use a pocket-type meat thermometer to make certain all products have reached an internal temperature of 140° to 160° F (60° to 71°C). If any food product is not at proper serving temperature, use a Halo Heat cooking and holding oven, set at 250° to 275°F (121° to 135°C), or a Combitherm oven, to bring the product within the correct temperature range.



### 3. RESET THERMOSTAT AS NEEDED

After all products are loaded, reset the thermostat to the number "8" setting. This will not necessarily be the final setting. Since proper temperature range depends on the type of products and the quantities being held, it is necessary to periodically use a pocket thermometer to check each item to make certain the correct temperatures are being maintained. Proper temperature range is between 140° to 160° F (60° to 71°C). Normally, this will require a thermostat setting of between number 7 and number 9, although a higher or lower setting may sometimes be required.

### 4. SERVE FRESH HOT FOOD

Keep hot foods looking fresh. Occasionally stir or rotate foods as needed. Wipe spills immediately to assure maximum eye appeal, and to ease end of the day cleanup.

- ▶ Use hand protection when handling hot items.
- ▶ Do not stack food containers.
- ▶ Be certain only hot PREPACKAGED foods in appropriate heat tested containers are used.

### HEATING CHARACTERISTICS

The shelf is equipped with a special, low-heat-density, heating cable. Through the Halo Heat concept, the heating cable is mounted against the top surface of the shelf to provide an evenly applied heat source, controlled by a thermostat. Through even heat application, the quality of a food product is maintained as much as several hours.

# OPERATION

## General Holding Guidelines

Chefs, cooks and other specialized food service personnel employ varied methods of cooking. Proper holding temperatures for a specific food product must be based on the moisture content of the product, product density, volume, and proper serving temperatures. Safe holding temperatures must also be correlated with palatability in determining the length of holding time for a specific product.

Halo Heat maintains the maximum amount of product moisture content without the addition of water, water vapor, or steam. Maintaining maximum natural product moisture preserves the natural flavor of the product and provides a more genuine taste. In addition to product moisture retention, the gentle properties of Halo Heat maintain a consistent temperature throughout the cabinet without the necessity of a heat distribution fan, thereby preventing further moisture loss due to evaporation or dehydration.

When product is removed from a high temperature cooking environment for immediate transfer into equipment with the lower temperature required for hot food holding, condensation can form on the outside of the product and on the inside of plastic containers used in self-service applications. Allowing the product to release the initial steam and heat produced by high temperature cooking can alleviate this condition. To preserve the safety and quality of freshly cooked foods however, a maximum of 1 to 2 minutes must be the only time period allowed for the initial heat to be released from the product.

This unit is equipped with a thermostat control between 60° and 200°F (16° and 93°C). If the unit is equipped with vents, close the vents for moist holding and open the vents for crisp holding. Use a metal-stemmed thermometer to measure the internal temperature of the product being held. Adjust the thermostat setting to achieve the best overall setting based on internal product temperature.

HOLDING TEMPERATURE RANGE		
	FAHRENHEIT	CELSIUS
<b>MEAT</b>		
BEEF ROAST — Rare	140°F	60°C
BEEF ROAST — Med/Well Done	160°F	71°C
BEEF BRISKET	160° — 175°F	71° — 79°C
CORN BEEF	160° — 175°F	71° — 79°C
PASTRAMI	160° — 175°F	71° — 79°C
PRIME RIB — Rare	140°F	60°C
STEAKS — Broiled/Fried	140° — 160°F	60° — 71°C
RIBS — Beef or Pork	160°F	71°C
VEAL	160° — 175°F	71° — 79°C
HAM	160° — 175°F	71° — 79°C
PORK	160° — 175°F	71° — 79°C
LAMB	160° — 175°F	71° — 79°C
<b>POULTRY</b>		
CHICKEN — Fried/Baked	160° — 175°F	71° — 79°C
DUCK	160° — 175°F	71° — 79°C
TURKEY	160° — 175°F	71° — 79°C
GENERAL	160° — 175°F	71° — 79°C
<b>FISH/SEAFOOD</b>		
FISH — Baked/Fried	160° — 175°F	71° — 79°C
LOBSTER	160° — 175°F	71° — 79°C
SHRIMP — Fried	160° — 175°F	71° — 79°C
<b>BAKED GOODS</b>		
BREADS/ROLLS	120° — 140°F	49° — 60°C
<b>MISCELLANEOUS</b>		
CASSEROLES	160° — 175°F	71° — 79°C
DOUGH — Proofing	80° — 100°F	27° — 38°C
EGGS — Fried	150° — 160°F	66° — 71°C
FROZEN ENTREES	160° — 175°F	71° — 79°C
HORS D'OEUVRES	160° — 180°F	71° — 82°C
PASTA	160° — 180°F	71° — 82°C
PIZZA	160° — 180°F	71° — 82°C
POTATOES	180°F	82°C
PLATED MEALS	180°F	82°C
SAUCES	140° — 200°F	60° — 93°C
SOUP	140° — 200°F	60° — 93°C
VEGETABLES	160° — 175°F	71° — 79°C
The holding temperatures listed are suggested guidelines only.		

## CLEANING AND PREVENTIVE MAINTENANCE

### PROTECTING STAINLESS STEEL SURFACES



It is important to guard against corrosion in the care of stainless steel surfaces.

Harsh, corrosive, or inappropriate chemicals can completely destroy the

protective surface layer of stainless steel. Abrasive pads, steel wool, or metal implements will abrade surfaces causing damage to this protective coating and will eventually result in areas of corrosion. Even water, particularly hard water that contains high to moderate concentrations of chloride, will cause oxidation and pitting that result in rust and corrosion. In addition, many acidic foods spilled and left to remain on metal surfaces are contributing factors that will corrode surfaces.

Proper cleaning agents, materials, and methods are vital to maintaining the appearance and life of this appliance. Spilled foods should be removed and the area wiped as soon as possible but at the very least, a minimum of once a day. Always thoroughly rinse surfaces after using a cleaning agent and wipe standing water as quickly as possible after rinsing.

### CLEANING AGENTS

Use non-abrasive cleaning products designed for use on stainless steel surfaces. Cleaning agents must be chloride-free compounds and must not contain quaternary salts. Never use hydrochloric acid (muriatic acid) on stainless steel surfaces. Always use the proper cleaning agent at the manufacturer's recommended strength. Contact your local cleaning supplier for product recommendations.

### CLEANING MATERIALS

The cleaning function can usually be accomplished with the proper cleaning agent and a soft, clean cloth. When more aggressive methods must be employed, use a non-abrasive scouring pad on difficult areas and make certain to scrub with the visible grain of surface metal to avoid surface scratches. Never use wire brushes, metal scouring pads, or scrapers to remove food residue.

	<p><b>! CAUTION</b></p> <p><b>TO PROTECT STAINLESS STEEL SURFACES, COMPLETELY AVOID THE USE OF ABRASIVE CLEANING COMPOUNDS, CHLORIDE BASED CLEANERS, OR CLEANERS CONTAINING QUATERNARY SALTS. NEVER USE HYDROCHLORIC ACID (MURIATIC ACID) ON STAINLESS STEEL. NEVER USE WIRE BRUSHES, METAL SCOURING PADS OR SCRAPERS.</b></p>
--	--

## CARE AND CLEANING

The cleanliness and appearance of this unit will contribute considerably to operating efficiency and savory, appetizing food. Good equipment that is kept clean works better and lasts longer.



### CLEAN THE UNIT THOROUGHLY AFTER EACH USE

1. Turn lights and adjustable thermostat to the "OFF" position.
2. Disconnect the unit from the power source.
3. Remove, cover or wrap, and store unused product under refrigeration. Let unit cool.
4. Clean the metal surfaces of the cabinet with a damp cloth and any good alkaline or alkaline chlorinated based commercial detergent or grease solvent at the recommended strength. Use a plastic scouring pad or oven cleaner for difficult areas. Avoid the use of abrasive cleaning compounds, chloride based cleaners, or cleaners containing quaternary salts. Rinse well to remove all residue and wipe dry.
5. To help maintain the protective film coating on polished stainless steel, clean the exterior of the cabinet with a cleaner recommended for stainless steel surfaces. Spray the cleaning agent on the cloth and wipe with the grain of the stainless steel.



6. Clean the acrylic sneeze guard with soap or mild detergent and water. Dry with a clean, damp chamois. Grease and oil may be removed with naphtha or hexane.

**NOTE:** Do not use commercial or household cleaners containing ammonia on the sneeze guard. To avoid scratching, do not use dry cloths or scouring compounds.

Always follow appropriate state or local health (hygiene) regulations regarding all applicable cleaning and sanitation requirements for food service equipment.



# SANITATION

Food flavor and aroma are usually so closely related that it is difficult, if not impossible, to separate them. There is also an important, inseparable relationship between cleanliness and food flavor. Cleanliness, top operating efficiency, and appearance of equipment contribute considerably to savory, appetizing foods. Good equipment that is kept clean, works better and lasts longer.

Most food imparts its own particular aroma and many foods also absorb existing odors. Unfortunately, during this absorption, there is no distinction between GOOD and BAD odors. The majority of objectionable flavors and odors troubling food service operations are caused by bacteria growth. Sourness, rancidity, mustiness, stale or other OFF flavors are usually the result of germ activity.

The easiest way to insure full, natural food flavor is through comprehensive cleanliness. This means good control of both visible soil (dirt) and invisible soil (germs). A thorough approach to sanitation will provide essential cleanliness. It will assure an attractive appearance of equipment, along with maximum efficiency and utility. More importantly, a good sanitation program provides one of the key elements in the prevention of food-borne illnesses.

A controlled holding environment for prepared foods is just one of the important factors involved in the prevention of food-borne illnesses. Temperature monitoring and control during receiving, storage, preparation, and the service of foods are of equal importance.

The most accurate method of measuring safe temperatures of both hot and cold foods is by internal product temperature. A quality thermometer is an effective tool for this purpose, and should be routinely used on all products that require holding at a specific temperature.

A comprehensive sanitation program should focus on the training of staff in basic sanitation procedures. This includes personal hygiene, proper handling of raw foods, cooking to a safe internal product temperature, and the routine monitoring of internal temperatures from receiving through service.

Most food-borne illnesses can be prevented through proper temperature control and a comprehensive program of sanitation. Both these factors are important to build quality service as the foundation of customer satisfaction. Safe food handling practices to prevent food-borne illness is of critical importance to the health and safety of your customers. HACCP, an acronym for Hazard Analysis (at) Critical Control Points, is a quality control program of operating procedures to assure food integrity, quality, and safety. Taking steps necessary to augment food safety practices are both cost effective and relatively simple. While HACCP guidelines go far beyond the scope of this manual, additional information is available by contacting:

**Center for Food Safety and Applied Nutrition  
Food and Drug Administration  
1-888-SAFEFOOD**

INTERNAL FOOD PRODUCT TEMPERATURES		
<b>HOT FOODS</b>		
DANGER ZONE	40° TO 140°F	(4° TO 60°C)
CRITICAL ZONE	70° TO 120°F	(21° TO 49°C)
SAFE ZONE	140° TO 165°F	(60° TO 74°C)
<b>COLD FOODS</b>		
DANGER ZONE	ABOVE 40°F	(ABOVE 4°C)
SAFE ZONE	36°F TO 40°F	(2°C TO 4°C)
<b>FROZEN FOODS</b>		
DANGER ZONE	ABOVE 32°F	(ABOVE 0°C)
CRITICAL ZONE	0° TO 32°F	(-18° TO 0°C)
SAFE ZONE	0°F OR BELOW	(-18°C OR BELOW)

# SERVICE

SERVICE PARTS LIST	Qty/Unit	Part No.	SERVICE PARTS LIST	Qty/Unit	Part No.
① Sneeze Guard	2	GD-24772	⑫ Switch Boot	2	SW-3905
② Control Box	1	44006	⑬ On/Off Rocker Switch (125V)	1	SW-33648
Control Box, w/o switch	1	16171	On/Off Rocker Switch (208-240V, 230V)	1	SW-33487
Control Box, 230V	1	16332	⑭ Panel Overlay, w/switch	1	PE-24665
③ Heat Guard	2	16175	Panel Overlay, w/o switch	1	PE-24666
④ Heat Guard Spacer	4	SP-24586	⑮ Insulation	1	IN-2003
⑤ Leg, flanged, 6" (152mm)	4	LG-23067	⑯ Terminal Block (125V, 208-240)	2	BK-3021
⑥ Bulb, 100W,130V, safety coated, std. (125V)	10	LP-33592	Terminal Block, (230V)	2	BK-3597
Bulb, 100W, 230-250V (208-240V,230V)	10	LP-33783	⑰ Gasket -- 2.7' (823mm)		GS-2750
⑦ Bulb Receptacle (125V)	10	RP-3952	⑱ Heating Cable -- see below		CB-3045
Bulb Receptacle (208-240V, 230V)	10	RP-3955			
⑧ Thermostat Knob	2	KN-3473	Cordset (125V)	1	CD-33366
⑨ Thermostat	2	TT-3498	Cordset (208-240V)	1	CD-3607
⑩ Indicator Light (125V)	2	LI-3027	Plug (208-240V)	1	PG-33236
Indicator Light (208-240V)	2	LI-3025	Cord Inlet, 230V	1	IT-33306
Indicator Light (230V)	2	LI-3951	Cordset (230V)	1	CD-33469
Nut, Indicator Light	2	NU-3335	Cordset (230V)	1	CD-33471
⑪ Light Toggle Switch	2	SW-3616			
Light Toggle Switch (230V)	2	SW-33726			

**See following pages  
for illustrations.**



Cable Heating Replacement Kit		125V	208-240V, 230V
includes:		<b>#4878</b>	<b>#4881</b>
CB-3045	Cable Heating Element	72 feet	210 feet
CR-3226	Ring Connector	4	12
IN-3488	Insulation Corner	1 foot	1 foot
BU-3105	Shoulder Bushing	4	12
BU-3106	Cup Bushing	4	12
SL-3063	Insulating Sleeve	4	12
TA-3540	High Temperature Tape	1 roll	1 roll
NU-2215	Hex Nut	8	24
ST-2439	Stud	4	12

## CAUTION



The performance of this unit has been optimized using the factory provided bulbs. These bulbs should be replaced with an exact replacement or with a factory recommended replacement. These bulbs have been treated to resist breakage and must be replaced with similarly treated bulbs in order to maintain compliance with NSF standards. **DO NOT** over-tighten bulbs in their receptacles as this can cause damage to the bulb filament.

# SERVICE



- ① Sneeze Guard
- ② Control Box
- ③ Heat Guard
- ④ Heat Guard Spacer
- ⑤ Adjustable 6" Legs
- ⑥ Bulbs
- ⑦ Bulb Receptacle

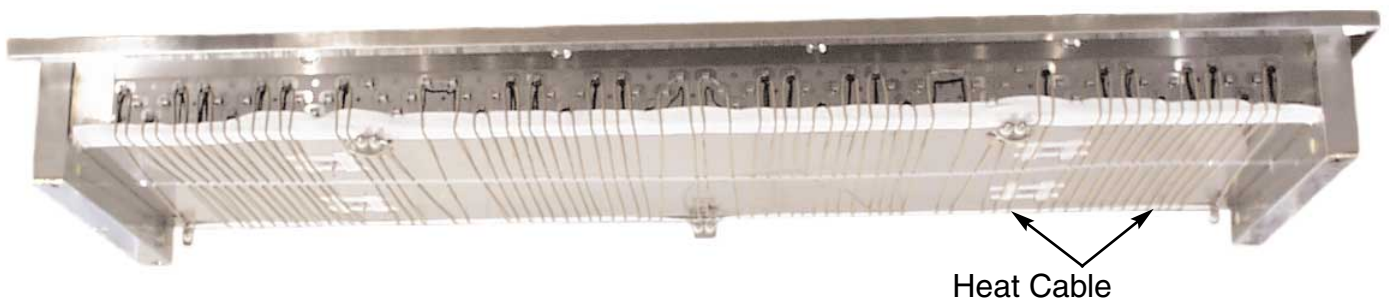

# CONTROL • SERVICE VIEW

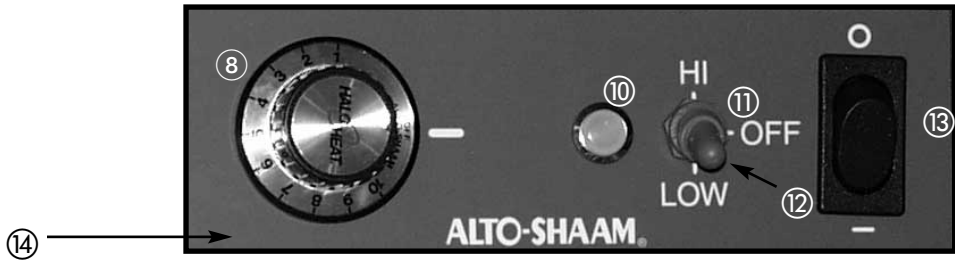

- ⑧ Thermostat Knob
- ⑨ Thermostat
- ⑩ Indicator Light
- ⑪ Light Switch
- ⑫ Switch Boot
- ⑬ On/Off Switch
- ⑭ Panel Overlay

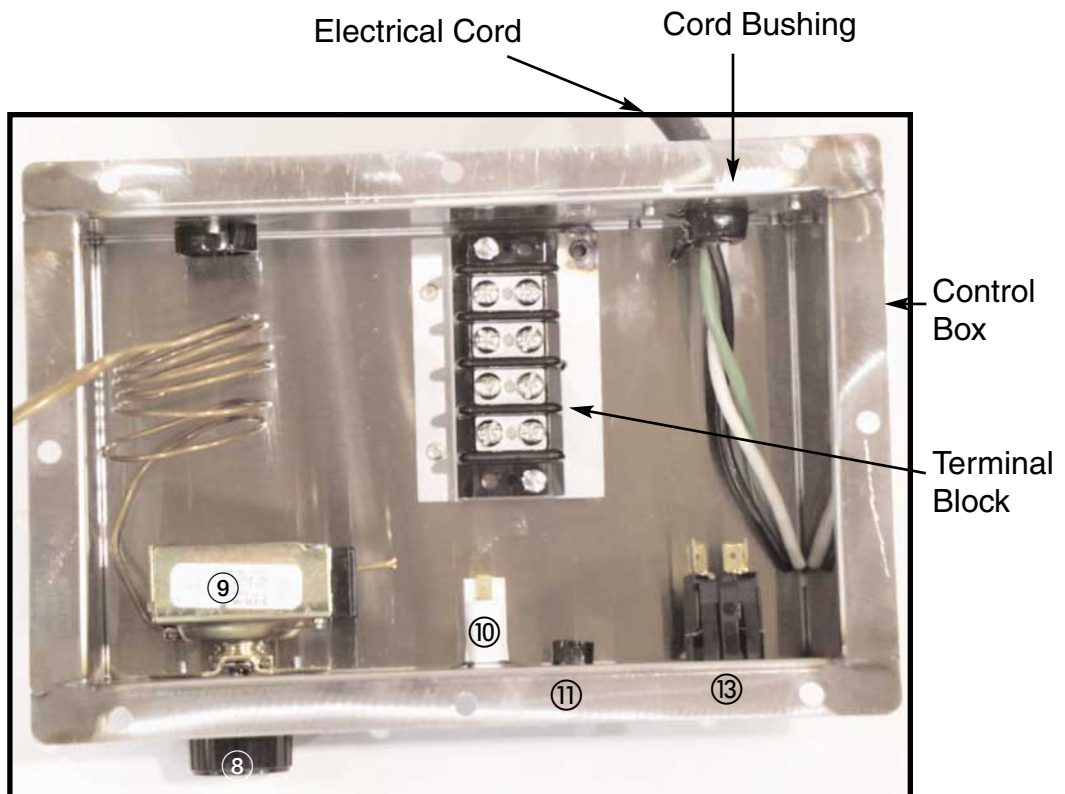

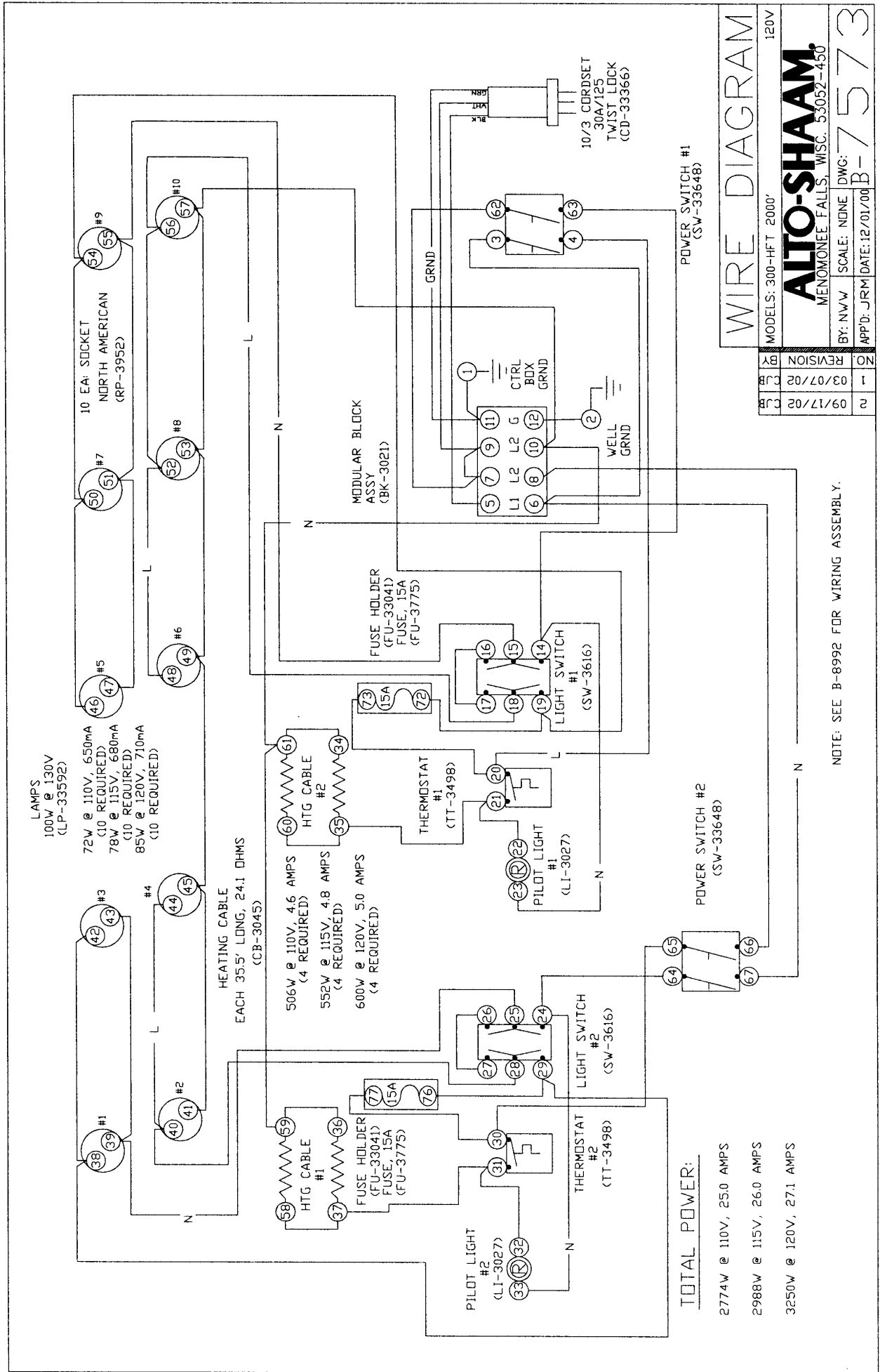

LAMPS (LP-33783)  
100W @ 230V, 435mA (10 REQUIRED)

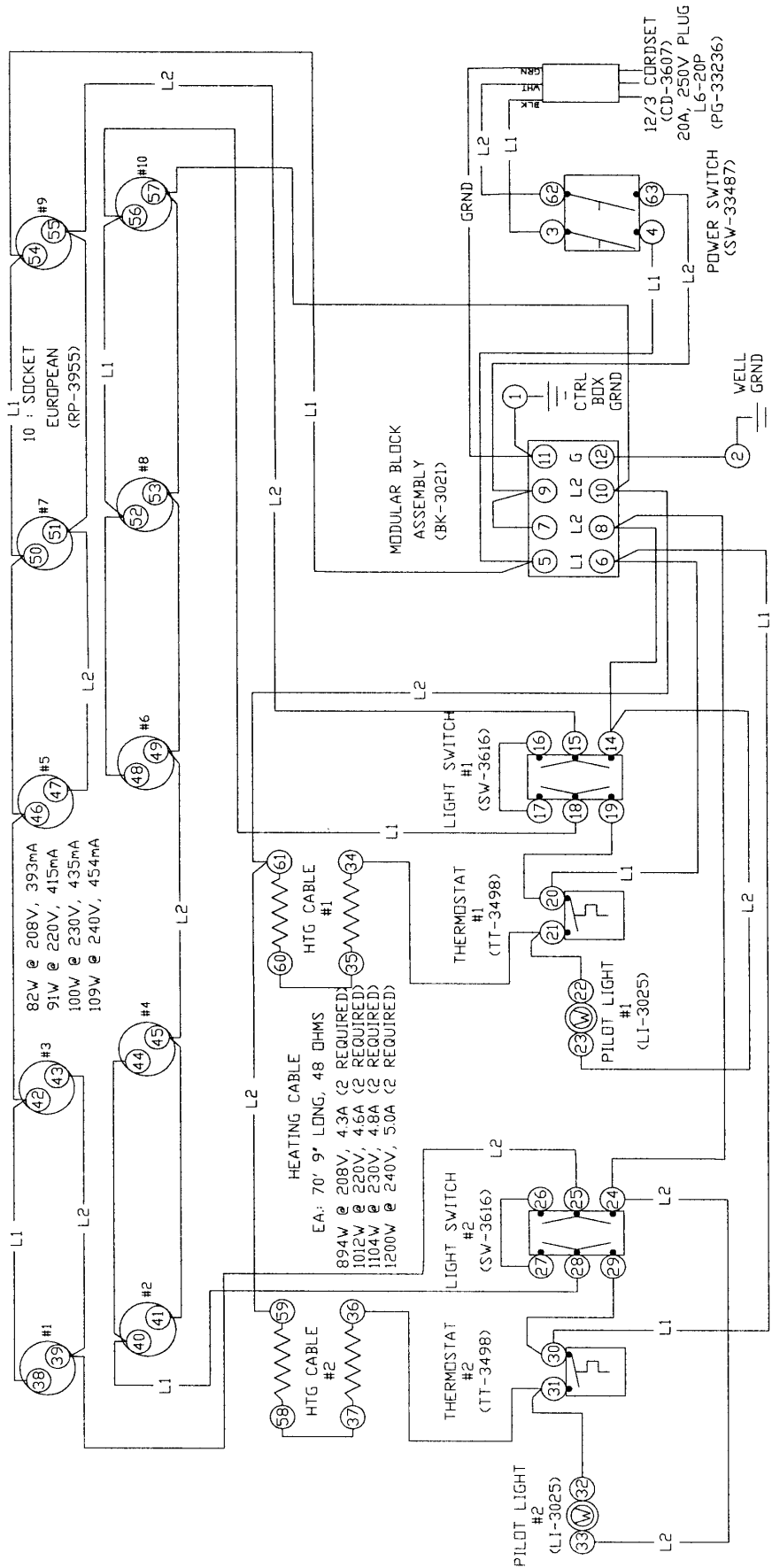

NOTE #1: SEE B-8993 FOR WIRE ASSEMBLY

WIRE DIAGRAM	
MODEL: 300-HFT-HST 2000'	208-240V
<b>ALTO-SHAAM</b>	
MEMORONEE FALLS, WISC. 53052-450	
BY: NAW	SCALE: NONE DWG: B-7574
APP'D: JRM	DATE: 12/01/00

TOTAL POWER:

- 2609W @ 208V, 12.5 AMPS
- 2844W @ 220V, 12.9 AMPS
- 3028W @ 230V, 13.2 AMPS
- 3220W @ 240V, 13.4 AMPS

LAMPS (LP-33783)  
100W @ 230V, 435mA (10 REQUIRED)

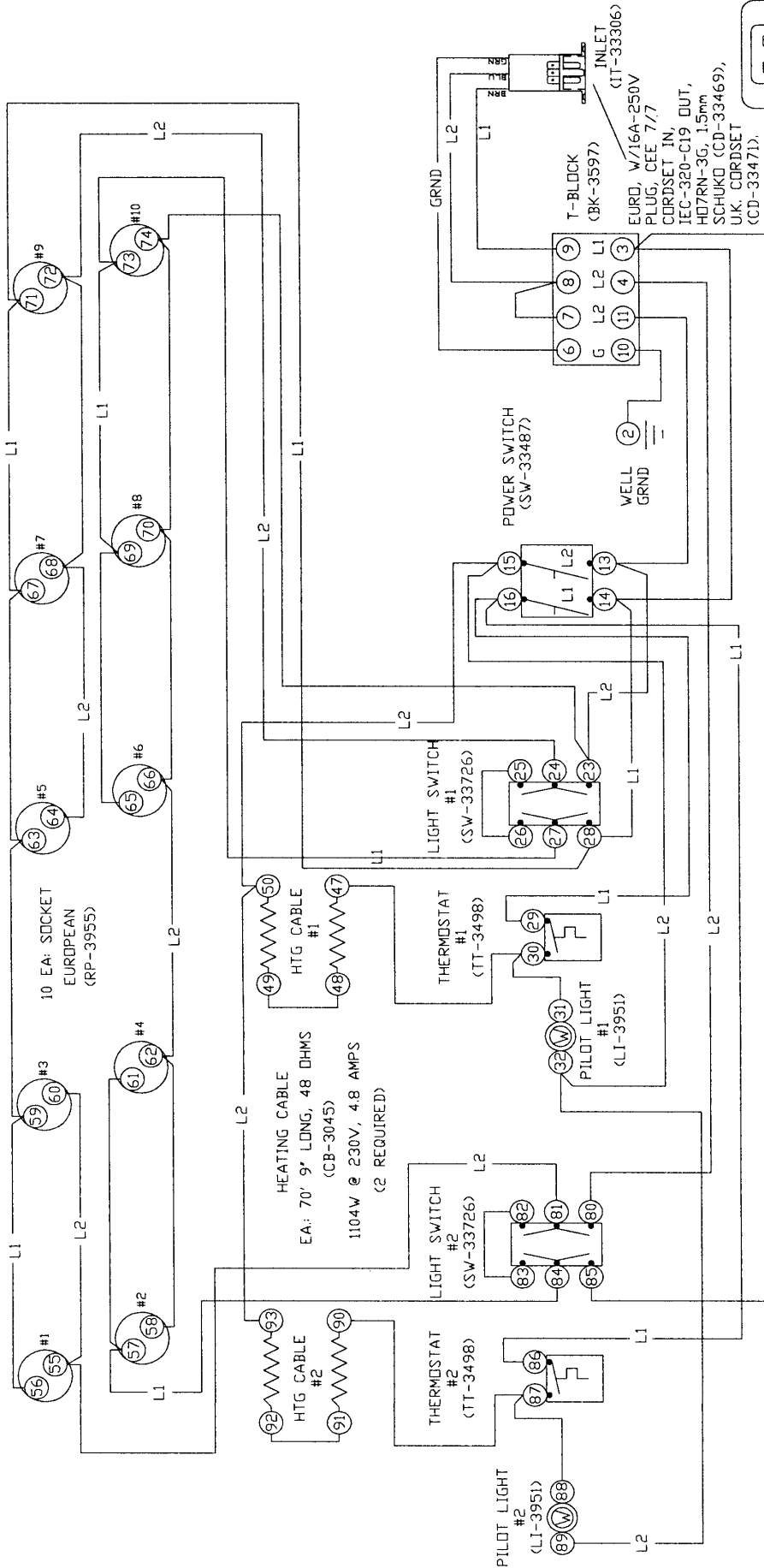

NOTE #1: SEE B-8994  
FOR WIRE ASSEMBLY.

TOTAL POWER:  
3250W @ 230V, 14.1 AMPS

# WIRE DIAGRAM

BY	REVISION	DATE	BY
1	06/12/01	1	08/13/02
2	09/26/01	2	12/27/01
3	12/27/01	3	08/13/02
4	08/13/02	4	

MODELS: 300-HFT, HST 2000' 230V  
**ALTO-SHAAM**  
MENOMONEE FALLS, WISC. 53052-450  
BY: N/W SCALE: NONE DWG: B-7575  
APP'D: JRM DATE: 12/01/00

# TRANSPORTATION DAMAGE and CLAIMS



# LIMITED WARRANTY



All Alto-Shaam equipment is sold F.O.B. shipping point, and when accepted by the carrier, such shipments become the property of the consignee.

Should damage occur in shipment, it is a matter between the carrier and the consignee. In such cases, the carrier is assumed to be responsible for the safe delivery of the merchandise, unless negligence can be established on the part of the shipper.

1. Make an immediate inspection while the equipment is still in the truck or immediately after it is moved to the receiving area. Do not wait until after the material is moved to a storage area.
2. Do not sign a delivery receipt or a freight bill until you have made a proper count and inspection of all merchandise received.
3. Note all damage to packages directly on the carrier's delivery receipt.
4. Make certain the driver signs this receipt. If he refuses to sign, make a notation of this refusal on the receipt.
5. If the driver refuses to allow inspection, write the following on the delivery receipt:  
*Driver refuses to allow inspection of containers for visible damage.*
6. Telephone the carrier's office immediately upon finding damage, and request an inspection. Mail a written confirmation of the time, date, and the person called.
7. Save any packages and packing material for further inspection by the carrier.
8. Promptly file a written claim with the carrier and attach copies of all supporting paperwork.

We will continue our policy of assisting our customers in collecting claims which have been properly filed and actively pursued. We cannot, however, file any damage claims for you, assume the responsibility of any claims, or accept deductions in payment for such claims.

Alto-Shaam, Inc. warrants to the original purchaser that any original part that is found to be defective in material or workmanship will, at Alto-Shaam's option, subject to provisions hereinafter stated, be replaced with a new or rebuilt part.

The labor warranty remains in effect one (1) year from installation or fifteen (15) months from the shipping date, whichever occurs first. Alto-Shaam will bear normal labor charges performed during standard business hours, and excluding overtime, holiday rates or any additional fees.

The parts warranty remains in effect for one (1) year from installation or fifteen (15) months from the shipping date, whichever occurs first.

However, the heating element on Halo Heat® cook/hold ovens and the refrigeration compressor on Alto-Shaam Quickchillers™ are warranted for a period of five (5) years from installation. The labor warranty is the same as stated above; namely, for one (1) year from installation or fifteen (15) months from the shipping date, whichever occurs first.

### THIS WARRANTY DOES NOT APPLY TO:

1. Calibration.
2. Replacement of light bulbs and/or the replacement of display case glass due to damage of any kind.
3. Equipment damage caused by accident, shipping, improper installation or alteration.
4. Equipment used under conditions of abuse, misuse, carelessness or abnormal conditions, including but not limited to equipment subjected to harsh or inappropriate chemicals including but not limited to compounds containing chloride or quaternary salts, poor water quality, or equipment with missing or altered serial numbers.
5. Damage incurred as a direct result of poor water quality, inadequate maintenance of steam generators and/or surfaces affected by water quality. Water quality and required maintenance of steam generating equipment is the responsibility of the owner/operator.
6. Damage caused by use of any cleaning agent other than Alto-Shaam's Combitherm® Cleaner, including but not limited to damage due to chlorine or other harmful chemicals. Use of Alto-Shaam's Combitherm® Cleaner on Combitherm® ovens is highly recommended.
7. Any losses or damage resulting from malfunction, including loss of product or consequential or incidental damages of any kind.
8. Equipment modified in any manner from original model, substitution of parts other than factory authorized parts, removal of any parts including legs, or addition of any parts.

This warranty is exclusive and is in lieu of all other warranties, expressed or implied, including the implied warranties of merchantability and fitness for a particular purpose. In no event shall Alto-Shaam be liable for loss of use, loss of revenue or profit, or loss of product, or for any indirect or consequential damages. No person except an officer of Alto-Shaam, Inc. is authorized to modify this warranty or to incur on behalf of Alto-Shaam any other obligation or liability in connection with Alto-Shaam equipment.

**ALTO-SHAAM, INC.**

RECORD THE MODEL AND SERIAL NUMBER OF THE APPLIANCE FOR EASY REFERENCE.  
ALWAYS REFER TO BOTH MODEL AND SERIAL NUMBER IN ANY CONTACT WITH ALTO-SHAAM REGARDING THIS APPLIANCE.

Model: \_\_\_\_\_ Date Installed: \_\_\_\_\_  
Voltage: \_\_\_\_\_ Purchased From: \_\_\_\_\_  
Serial Number: \_\_\_\_\_

**W164 N9221 Water Street • P.O. Box 450 • Menomonee Falls, Wisconsin 53052-0450 • U.S.A.**

PHONE: 262.251.3800 • 800.558-8744 USA/CANADA

FAX: 262.251.7067 • 800.329.8744 U.S.A. ONLY

WEBSITE: [www.alto-shaam.com](http://www.alto-shaam.com)

PRINTED IN U.S.A.