

**ALTO SHAAM®**

**Hot Food Shelf  
with Granite Insert**

**Model:  
200-HST/G**



- **INSTALLATION**
- **OPERATION**
- **MAINTENANCE**



**W164 N9221 Water Street • P.O. Box 450 • Menomonee Falls, Wisconsin 53052-0450 USA**

PHONE: 262.251.3800 • 800.558.8744 USA/CANADA

FAX: 262.251.7067 • 800.329.8744 U.S.A. ONLY

WEBSITE: [www.alto-shaam.com](http://www.alto-shaam.com)

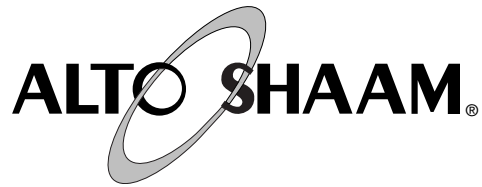

## DELIVERY

This Alto-Shaam appliance has been thoroughly tested and inspected to insure only the highest quality unit is provided. Upon receipt, check for any possible shipping damage and report it at once to the delivering carrier. *See Transportation Damage and Claims section located in this manual.*

This appliance, complete with unattached items and accessories, may have been delivered in one or more packages. Check to ensure that all standard items and options have been received with each model as ordered.

Save all the information and instructions packed with the appliance. Complete and return the warranty card to the factory as soon as possible to assure prompt service in the event of a warranty parts and labor claim.

This manual must be read and understood by all people using or installing the equipment model. Contact the Alto-Shaam service department if you have any questions concerning installation, operation, or maintenance.

**NOTE:** All claims for warranty must include the full model number and serial number of the unit.

## UNPACKING

1. Carefully remove the appliance from the carton or crate.

**NOTE:** Do not discard the carton and other packaging material until you have inspected the unit for hidden damage and tested it for proper operation.

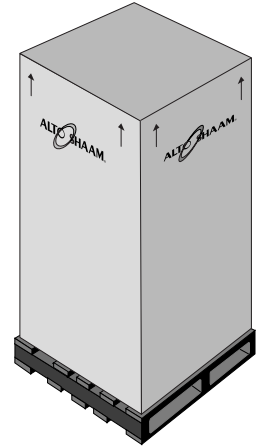

2. Read all instructions in this manual carefully before initiating the installation of this appliance.

### **DO NOT DISCARD THIS MANUAL.**

This manual is considered to be part of the appliance and is to be provided to the owner or manager of the business or to the person responsible for training operators. *Additional manuals are available from the Alto-Shaam service department.*

3. Remove all protective plastic film, packaging materials, and accessories from the appliance before connecting electrical power. Store any accessories in a convenient place for future use.

## SAFETY PROCEDURES AND PRECAUTIONS

Knowledge of proper procedures is essential to the safe operation of electrically and/or gas energized equipment. In accordance with generally accepted product safety labeling guidelines for potential hazards, the following signal words and symbols may be used throughout this manual.



### DANGER

Used to indicate the presence of a hazard that **will** cause severe personal injury, death, or substantial property damage if the warning included with this symbol is ignored.



### WARNING

Used to indicate the presence of a hazard that **can** cause personal injury, possible death, or major property damage if the warning included with this symbol is ignored.



### CAUTION

Used to indicate the presence of a hazard that can or will cause minor or moderate personal injury or property damage if the warning included with this symbol is ignored.

### CAUTION

Used to indicate the presence of a hazard that can or will cause minor personal injury, property damage, or a potential unsafe practice if the warning included with this symbol is ignored.

### NOTE:

Used to notify personnel of installation, operation, or maintenance information that is important but not hazard related.

1. This appliance is intended to cook, hold or process foods for the purpose of human consumption. No other use for this appliance is authorized or recommended.
2. This appliance is intended for use in commercial establishments where all operators are familiar with the purpose, limitations, and associated hazards of this appliance. Operating instructions and warnings must be read and understood by all operators and users.
3. Any troubleshooting guides, component views, and parts lists included in this manual are for general reference only and are intended for use by qualified technical personnel.
4. This manual should be considered a permanent part of this appliance. This manual and all supplied instructions, diagrams, schematics, parts lists, notices, and labels must remain with the appliance if the item is sold or moved to another location.

## NOTE



For equipment delivered for use in any location regulated by the following directive:

**DO NOT DISPOSE OF ELECTRICAL OR ELECTRONIC EQUIPMENT WITH OTHER MUNICIPAL WASTE.**

# INSTALLATION

## SITE INSTALLATION

The heated shelf, complete with unattached items and accessories, should be checked to ensure all the ordered items have been received with the unit.

The heated solid surface material insert will come in a separate shipment, or could be ordered by the customer from a source other than Alto-Shaam.

Alto-Shaam hot shelves are designed for the purpose of maintaining hot food at a temperature for safe consumption. The unit must be installed on a level surface in a location that will permit the equipment to function for its intended purpose and allow adequate access for proper cleaning and maintenance.

The appliance must not be installed in any area where it will be affected by steam, grease, dripping water, high temperatures, or any other severely adverse conditions.

### HEATED SOLID SURFACE INSERT:

The solid surface material insert must be 1/2" to 1" (12.5mm to 25mm) thick. It must be sealed with NSF listed silicone to close the gap between the well and the insert. Follow the manufacturer's instructions for installation, maintenance, and cleaning.

In most cases a granite insert will be the heat source for this hot food shelf. A sealed granite insert provides even heat transfer to hot food being held in direct contact with the granite top. This granite must be properly sealed so hot pans will not cause damage, scratches, staining and blistering due to heat. Always follow manufacturer's instructions for its care.

A cutting board is recommended on this surface. The use of a stone sealer will help the stone become less porous.



Level the appliance from side-to-side and front-to-back with the use of a spirit level.

### OPENING REQUIRED FOR DROP-IN APPLICATION:

43" L x 24-1/16" W (1093mm x 611mm)

## USER SAFETY INFORMATION

**DANGER**

**IMPROPER INSTALLATION, ALTERATION, ADJUSTMENT, SERVICE OR MAINTENANCE COULD RESULT IN SEVERE INJURY, DEATH OR CAUSE PROPERTY DAMAGE.**

This appliance is intended for use in commercial establishments by qualified personnel who are familiar with the purpose, limitations, and associated hazards of this appliance. Operating instructions and warnings must be read and understood by all operators and users.

### BEFORE USE:

Before operating the unit, clean with a clean, damp cloth and mild soap solution. Rinse surface by wiping with a clean sponge and clean warm water. Remove excess water with sponge and wipe dry with a clean cloth or air dry.

PRODUCT CAPACITY	
36 lb (16 kg) MAXIMUM	

WEIGHT (WITHOUT INSERT)	
NET	89 lb (40 kg)
SHIP	112 lb (51 kg)
CRATE	22" x 48" x 38"
DIMENSIONS:	(559mm x 1245mm x 965mm)



## CAUTION

TO PREVENT PERSONAL INJURY, USE CAUTION WHEN MOVING OR LEVELING THIS APPLIANCE.

# INSTALLATION

## EXTERIOR DIMENSIONS

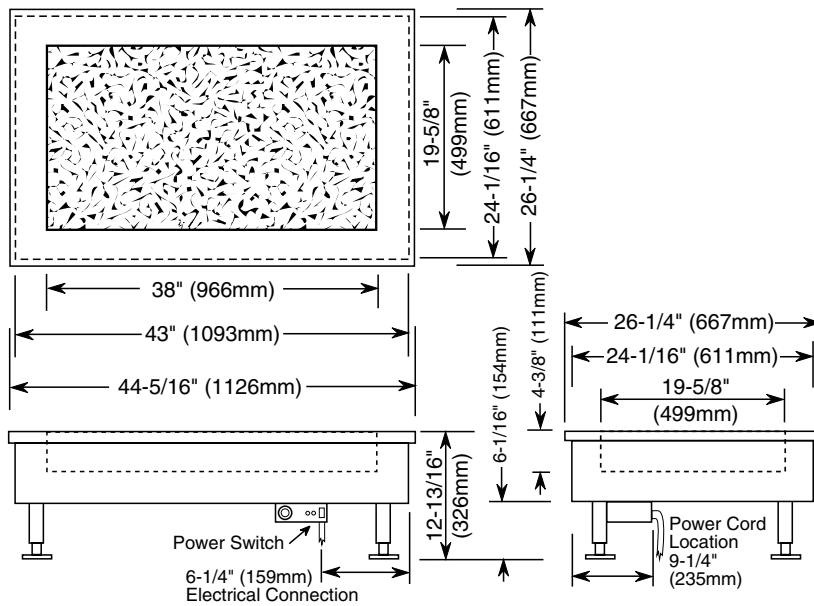

### OPTIONS & ACCESSORIES

Granite Color Choice		Cart, Mobile, ENCLOSED ON 3 SIDES, 4TH SIDE WITH 2 SHELVES	
<input type="checkbox"/> Grey	GR-25435	<input type="checkbox"/> Basic, unfinished cart	55185
<input type="checkbox"/> Impala Black	GR-25636	<input type="checkbox"/> Stainless steel panel package	44078
<input type="checkbox"/> Remote Control	5000729	<input type="checkbox"/> Painted enamel panel package, COLOR OF CHOICE	44075
<input type="checkbox"/> Cutting board	BA-2054		

# INSTALLATION

## ELECTRICAL CONNECTION

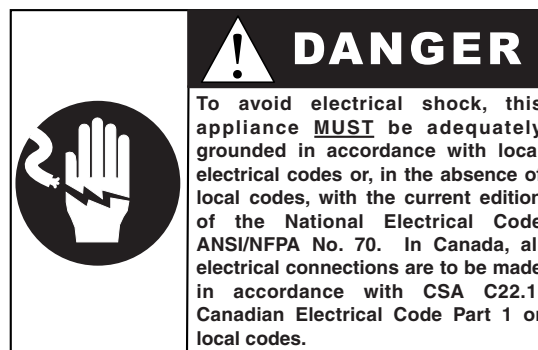
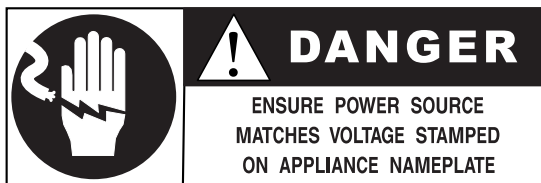

1. An identification tag is permanently mounted on the unit.
2. If necessary, a proper receptacle or permanent wiring for this unit must be installed by a licensed electrician in accordance with applicable local electrical codes.
3. Plug the unit into a properly grounded receptacle **ONLY**, positioning the unit so the power supply cord is easily accessible in case of an emergency. Arcing will occur when connecting or disconnecting the unit unless all controls are in the OFF position.



ELECTRICAL					
VOLTAGE	PHASE	CYCLE/HZ	AMPS	kW	
125	1	60	11.7	1.5	BARE END NO PLUG

## OPERATION

1. **Switch unit on.**
2. **Turn thermostat to number 9 and preheat for 30 minutes.**

When the thermostat is turned clockwise to the "9" position, the indicator light will illuminate and will remain lit as long as the unit is calling for heat. Allow a minimum of 30 minutes of preheat before putting hot food on the shelf.

The indicator light will go OUT after approximately 30 minutes, or when the temperature on the granite top reaches the temperature set by the operator.

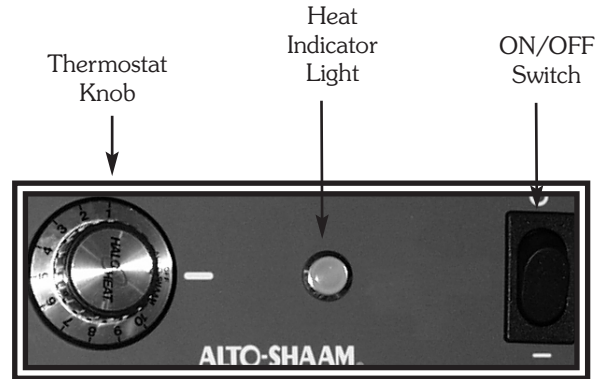

3. **Put only hot food on the shelf.**

This hot shelf is meant for hot hors'doeuvres, and designed to maintain hot food at proper serving temperatures. Only hot food in heat tested containers should be placed on it. Use a food thermometer to make certain all food products are at an internal temperature range of 140° to 160°F (60° to 71°C). All food not within the proper temperature range should be heated before putting on the hot food shelf.

The proper temperature range for the food being held will depend on the type and quantity of product. When holding food for prolonged periods, it is advisable to periodically check the internal temperature of each item to assure maintenance of the proper temperature range.

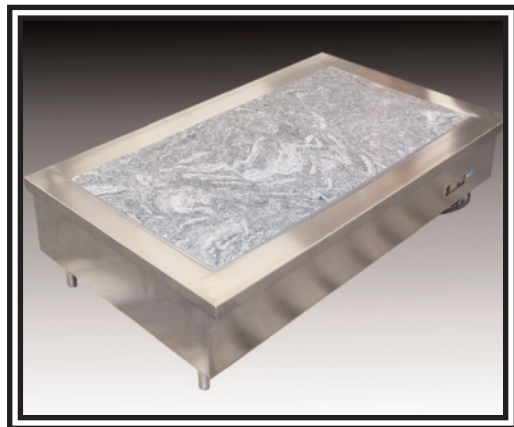

4. **A cutting board is recommended for the heated surface.**

# OPERATION

## GENERAL HOLDING GUIDELINES

Chefs, cooks and other specialized food service personnel employ varied methods of cooking. Proper holding temperatures for a specific food product must be based on the moisture content of the product, product density, volume, and proper serving temperatures. Safe holding temperatures must also be correlated with palatability in determining the length of holding time for a specific product.

Halo Heat maintains the maximum amount of product moisture content without the addition of water, water vapor, or steam. Maintaining maximum natural product moisture preserves the natural flavor of the product and provides a more genuine taste. In addition to product moisture retention, the gentle properties of Halo Heat maintain a consistent temperature throughout the cabinet without the necessity of a heat distribution fan, thereby preventing further moisture loss due to evaporation or dehydration.

When product is removed from a high temperature cooking environment for immediate transfer into equipment with the lower temperature required for hot food holding, condensation can form on the outside of the product and on the inside of plastic containers used in self-service applications. Allowing the product to release the initial steam and heat produced by high temperature cooking can alleviate this condition. To preserve the safety and quality of freshly cooked foods however, a maximum of 1 to 2 minutes must be the only time period allowed for the initial heat to be released from the product.

This unit is equipped with a thermostat indicating a range of between 1 and 10, use a metal-stemmed indicating thermometer to measure the internal temperature of the product(s) being held. Adjust the thermostat setting to achieve the best overall setting based on internal product temperature.

<b>HOLDING TEMPERATURE RANGE</b>		
<b>MEAT</b>	<b>FAHRENHEIT</b>	<b>CELSIUS</b>
BEEF ROAST — Rare	140°F	60°C
BEEF ROAST — Med/Well Done	160°F	71°C
BEEF BRISKET	160° — 175°F	71° — 79°C
CORN BEEF	160° — 175°F	71° — 79°C
PASTRAMI	160° — 175°F	71° — 79°C
PRIME RIB — Rare	140°F	60°C
STEAKS — Broiled/Fried	140° — 160°F	60° — 71°C
RIBS — Beef or Pork	160°F	71°C
VEAL	160° — 175°F	71° — 79°C
HAM	160° — 175°F	71° — 79°C
PORK	160° — 175°F	71° — 79°C
LAMB	160° — 175°F	71° — 79°C
<b>POULTRY</b>		
CHICKEN — Fried/Baked	160° — 175°F	71° — 79°C
DUCK	160° — 175°F	71° — 79°C
TURKEY	160° — 175°F	71° — 79°C
GENERAL	160° — 175°F	71° — 79°C
<b>FISH/SEAFOOD</b>		
FISH — Baked/Fried	160° — 175°F	71° — 79°C
LOBSTER	160° — 175°F	71° — 79°C
SHRIMP — Fried	160° — 175°F	71° — 79°C
<b>BAKED GOODS</b>		
BREADS/ROLLS	120° — 140°F	49° — 60°C
<b>MISCELLANEOUS</b>		
CASSEROLES	160° — 175°F	71° — 79°C
DOUGH — Proofing	80° — 100°F	27° — 38°C
EGGS —Fried	150° — 160°F	66° — 71°C
FROZEN ENTREES	160° — 175°F	71° — 79°C
HORS D'OEUVRES	160° — 180°F	71° — 82°C
PASTA	160° — 180°F	71° — 82°C
PIZZA	160° — 180°F	71° — 82°C
POTATOES	180°F	82°C
PLATED MEALS	180°F	82°C
SAUCES	140° — 200°F	60° — 93°C
SOUP	140° — 200°F	60° — 93°C
VEGETABLES	160° — 175°F	71° — 79°C
The holding temperatures listed are suggested guidelines only.		

## CLEANING AND PREVENTIVE MAINTENANCE

### PROTECTING STAINLESS STEEL SURFACES



It is important to guard against corrosion in the care of stainless steel surfaces. Harsh, corrosive, or inappropriate chemicals can completely destroy the protective surface layer of stainless steel. Abrasive pads, steel wool, or metal implements will abrade surfaces causing damage to this protective coating and will eventually result in areas of corrosion. Even water, particularly hard water that contains high to moderate concentrations of chloride, will cause oxidation and pitting that result in rust and corrosion. In addition, many acidic foods spilled and left to remain on metal surfaces are contributing factors that will corrode surfaces.

Proper cleaning agents, materials, and methods are vital to maintaining the appearance and life of this appliance. Spilled foods should be removed and the area wiped as soon as possible but at the very least, a minimum of once a day. Always thoroughly rinse surfaces after using a cleaning agent and wipe standing water as quickly as possible after rinsing.

### CLEANING AGENTS

Use non-abrasive cleaning products designed for use on stainless steel surfaces. Cleaning agents must be chloride-free compounds and must not contain quaternary salts. Never use hydrochloric acid (muriatic acid) on stainless steel surfaces. Always use the proper cleaning agent at the manufacturer's recommended strength. Contact your local cleaning supplier for product recommendations.

### CLEANING MATERIALS

The cleaning function can usually be accomplished with the proper cleaning agent and a soft, clean cloth. When more aggressive methods must be employed, use a non-abrasive scouring pad on difficult areas and make certain to scrub with the visible grain of surface metal to avoid surface scratches. Never use wire brushes, metal scouring pads, or scrapers to remove food residue.

	<p><b>! CAUTION</b></p> <p><b>TO PROTECT STAINLESS STEEL SURFACES, COMPLETELY AVOID THE USE OF ABRASIVE CLEANING COMPOUNDS, CHLORIDE BASED CLEANERS, OR CLEANERS CONTAINING QUATERNARY SALTS. NEVER USE HYDROCHLORIC ACID (MURIATIC ACID) ON STAINLESS STEEL. NEVER USE WIRE BRUSHES, METAL SCOURING PADS OR SCRAPERS.</b></p>
---	--

## CARE and CLEANING



The cleanliness and appearance of this unit will contribute considerably to operating efficiency and savory, appetizing food. Good equipment kept clean works better and lasts longer.



### THOROUGHLY CLEAN THE UNIT DAILY

1. Disconnect unit from power source, and let cool.
2. Always follow the manufacturer's directions for the cleaning and care of the heated solid surface material insert. Spills should be wiped up promptly to avoid etching or staining.
3. To help maintain the protective film coating on polished **stainless steel**, clean the exterior of the unit with a cleaner recommended for stainless steel surfaces. Spray the cleaning agent on a cloth and wipe with the grain of the stainless steel.

A granite surface should be washed regularly with fresh warm water, a mild detergent, and a clean, non-abrasive cloth. A marble surface is softer, and less stain-resistant than granite, and is susceptible to damage from citric acids, alcohols and oils.

Avoid detergents that can be abrasive and contain chemicals high in acid or alkaline (no vinegar, lemon or acidic additives). These chemicals can etch or remove the polish on any stone surface. Be sure to use a cleaner which does not have a petroleum or oil base and contains chemicals that will be safe on the finish of granite.

Rinse surfaces by wiping with a clean sponge and clean warm water. Remove excess water with sponge and wipe dry with a clean cloth or air dry.

Avoid the use of abrasive cleaning compounds, chloride based cleaners, or cleaners containing quaternary salts on stainless steel. Never use hydrochloric acid (muriatic acid) on stainless steel.



Always follow appropriate state or local health (hygiene) regulations regarding all applicable cleaning and sanitation requirements for foodservice equipment.



# SANITATION

Food flavor and aroma are usually so closely related that it is difficult, if not impossible, to separate them. There is also an important, inseparable relationship between cleanliness and food flavor. Cleanliness, top operating efficiency, and appearance of equipment contribute considerably to savory, appetizing foods. Good equipment that is kept clean, works better and lasts longer.

Most food imparts its own particular aroma and many foods also absorb existing odors. Unfortunately, during this absorption, there is no distinction between GOOD and BAD odors. The majority of objectionable flavors and odors troubling food service operations are caused by bacteria growth. Sourness, rancidity, mustiness, stale or other OFF flavors are usually the result of germ activity.

The easiest way to insure full, natural food flavor is through comprehensive cleanliness. This means good control of both visible soil (dirt) and invisible soil (germs). A thorough approach to sanitation will provide essential cleanliness. It will assure an attractive appearance of equipment, along with maximum efficiency and utility. More importantly, a good sanitation program provides one of the key elements in the prevention of food-borne illnesses.

A controlled holding environment for prepared foods is just one of the important factors involved in the prevention of food-borne illnesses. Temperature monitoring and control during receiving, storage, preparation, and the service of foods are of equal importance.

The most accurate method of measuring safe temperatures of both hot and cold foods is by internal product temperature. A quality thermometer is an effective tool for this purpose, and should be routinely used on all products that require holding at a specific temperature.

A comprehensive sanitation program should focus on the training of staff in basic sanitation procedures. This includes personal hygiene, proper handling of raw foods, cooking to a safe internal product temperature, and the routine monitoring of internal temperatures from receiving through service.

Most food-borne illnesses can be prevented through proper temperature control and a comprehensive program of sanitation. Both these factors are important to build quality service as the foundation of customer satisfaction. Safe food handling practices to prevent food-borne illness is of critical importance to the health and safety of your customers. HACCP, an acronym for Hazard Analysis (at) Critical Control Points, is a quality control program of operating procedures to assure food integrity, quality, and safety. Taking steps necessary to augment food safety practices are both cost effective and relatively simple. While HACCP guidelines go far beyond the scope of this manual, additional information is available by contacting:

Center for Food Safety and Applied Nutrition  
Food and Drug Administration  
1-888-SAFEFOOD

INTERNAL FOOD PRODUCT TEMPERATURES		
<b>HOT FOODS</b>		
DANGER ZONE	40° TO 140°F	(4° TO 60°C)
CRITICAL ZONE	70° TO 120°F	(21° TO 49°C)
SAFE ZONE	140° TO 165°F	(60° TO 74°C)
<b>COLD FOODS</b>		
DANGER ZONE	ABOVE 40°F	(ABOVE 4°C)
SAFE ZONE	36°F TO 40°F	(2°C TO 4°C)
<b>FROZEN FOODS</b>		
DANGER ZONE	ABOVE 32°F	(ABOVE 0°C)
CRITICAL ZONE	0° TO 32°F	(-18° TO 0°C)
SAFE ZONE	0°F OR BELOW	(-18°C OR BELOW)

## SERVICE

<b>Description</b>	<b>Part Number</b>
Cable for heat, 62' (1890 cm)	CB-3045
Electrical Cord, 7' (2134 mm), for remote unit	CD-3338
Cordset	CD-33367
Cord Bushing	BU-3964
Flexible Conduit, 6' (1829 mm) for remote unit	TU-3874
Granite top, Impala Black	GR-25636
Granite top, Grey	GR-25435
Indicator Light	LI-3027
Knob for thermostat	KN-3473
Leg, flanged, 6" (152 mm)	LG-23067
Panel Overlay	PE-24665
Panel Overlay for remote unit	PE-25553
Thermostat	TT-3498
T-Block	BK-3021
Switch for power	SW-33648



HI-TEMP HEATING CABLE  
2'- 31' FEET, 21 OHMS EACH  
(CB-3045)

1150W @ 110V, 10.4 AMPS  
1258W @ 115V, 10.9 AMPS  
1368W @ 120V, 11.4 AMPS  
1468W @ 125V, 11.7 AMPS

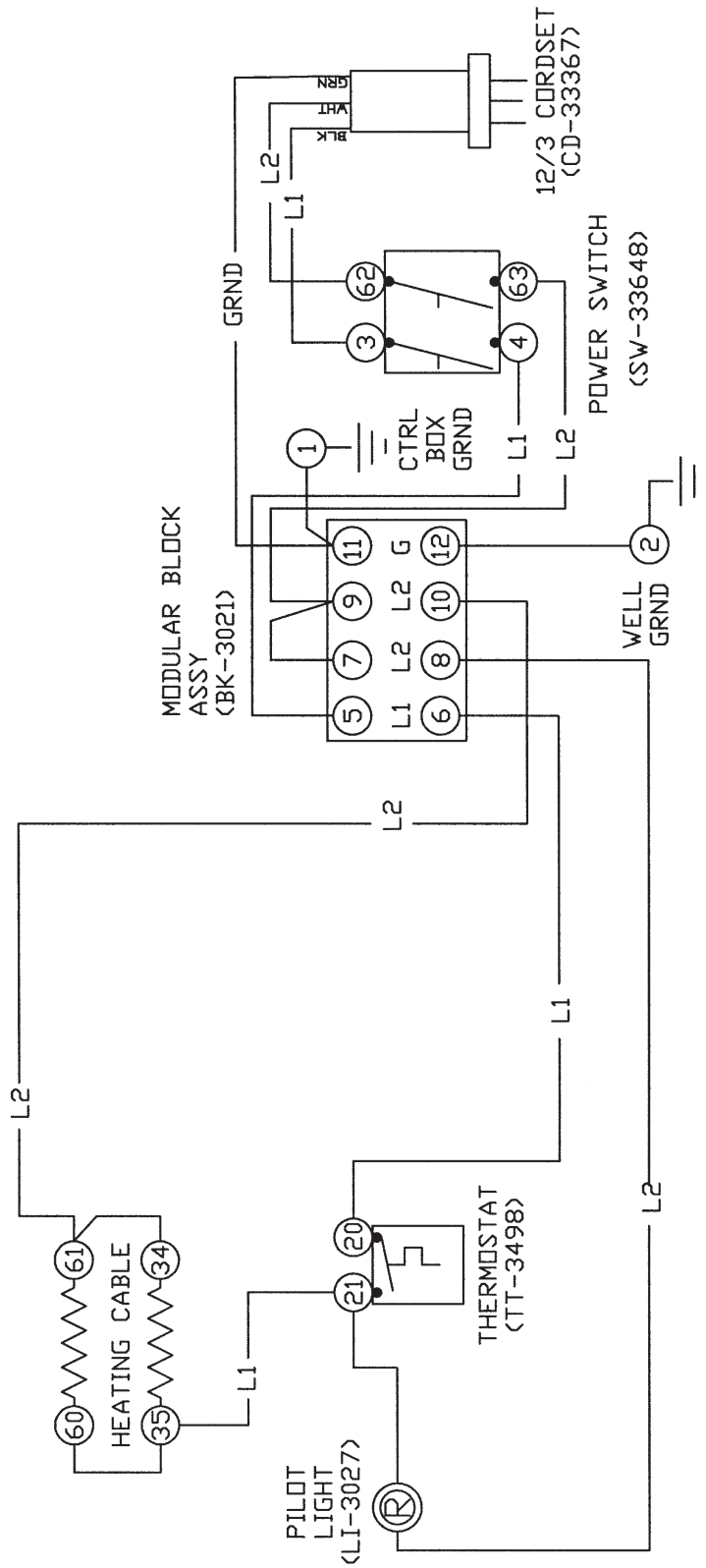

NOTE #1: SEE DRW #I:ENG/PRODUCTION/DWG8/8178  
FOR WIRING  
ASSEMBLY DRAWING.

TOTAL POWER:

1150W @ 110V, 10.4 AMPS  
1258W @ 115V, 10.9 AMPS  
1368W @ 120V, 11.4 AMPS  
1468W @ 125V, 11.7 AMPS

# WIRING DIAGRAM

MODELS: 200-HST/G,W/D REMOTE

**ALTO-SHAM**  
MENOMONEE FALLS, WISC. 53052-450

BY: DHT	SCALE: 1"=1'	DWG: A-7670
APP'D: P.E.D	DATE: 08/25/03	

TOTAL POWER:  
 1150W @ 110V, 10.4 AMPS  
 1258W @ 115V, 10.9 AMPS  
 1368W @ 120V, 11.4 AMPS  
 1468W @ 125V, 11.7 AMPS

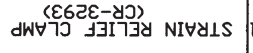
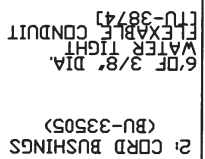
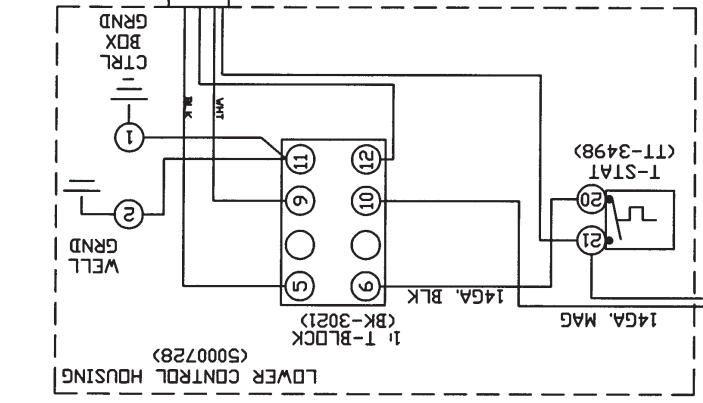
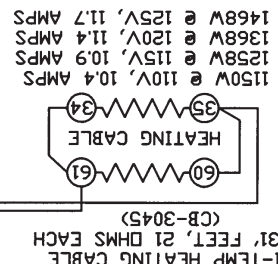
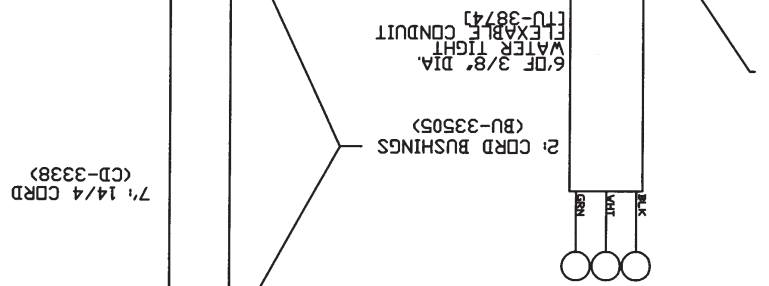
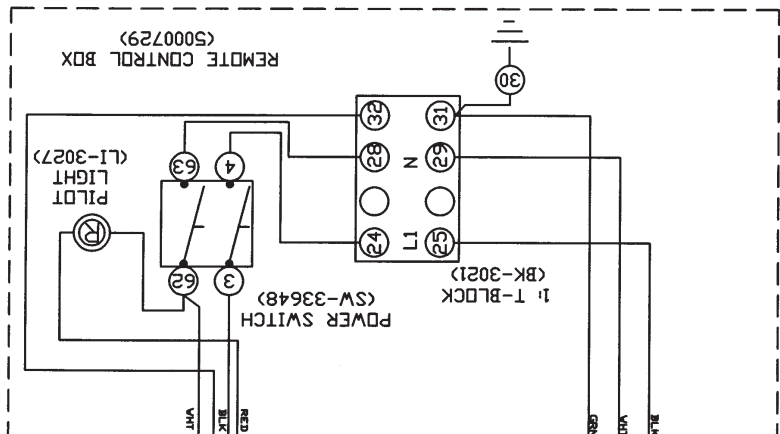

# WIRE DIAGRAM - REMOTE CONTROL

MODELS: 200-HST W/REMOTE 120V

**ALTO-SHAAM®**  
 MENOMONEE FALLS, WISC. 53052-450

CUT SIZE:  
 MATERIAL:  
 DESCRIPTION:  
 QUANTITY:  
 APPROVAL: PED

SCALE: 3/4" = 1'  
 BY: M S DATE: 01/23/03  
 DWG: A-7652

NOTE #1: ALL NUMBERS IN ○ = ALTO-SHAAM PART NO'S  
 NOTE #2: SEE DRW. #A-8144 FOR WIRE ASSEMBLIES

# TRANSPORTATION DAMAGE and CLAIMS

# ALTO SHAAM<sup>®</sup> LIMITED WARRANTY



All Alto-Shaam equipment is sold F.O.B. shipping point, and when accepted by the carrier, such shipments become the property of the consignee.

Should damage occur in shipment, it is a matter between the carrier and the consignee. In such cases, the carrier is assumed to be responsible for the safe delivery of the merchandise, unless negligence can be established on the part of the shipper.

1. Make an immediate inspection while the equipment is still in the truck or immediately after it is moved to the receiving area. Do not wait until after the material is moved to a storage area.
2. Do not sign a delivery receipt or a freight bill until you have made a proper count and inspection of all merchandise received.
3. Note all damage to packages directly on the carrier's delivery receipt.
4. Make certain the driver signs this receipt. If he refuses to sign, make a notation of this refusal on the receipt.
5. If the driver refuses to allow inspection, write the following on the delivery receipt:  
*Driver refuses to allow inspection of containers for visible damage.*
6. Telephone the carrier's office immediately upon finding damage, and request an inspection. Mail a written confirmation of the time, date, and the person called.
7. Save any packages and packing material for further inspection by the carrier.
8. Promptly file a written claim with the carrier and attach copies of all supporting paperwork.

We will continue our policy of assisting our customers in collecting claims which have been properly filed and actively pursued. We cannot, however, file any damage claims for you, assume the responsibility of any claims, or accept deductions in payment for such claims.

Alto-Shaam, Inc. warrants to the original purchaser that any original part that is found to be defective in material or workmanship will, at Alto-Shaam's option, subject to provisions hereinafter stated, be replaced with a new or rebuilt part.

The labor warranty remains in effect one (1) year from installation or fifteen (15) months from the shipping date, whichever occurs first. Alto-Shaam will bear normal labor charges performed during standard business hours, and excluding overtime, holiday rates or any additional fees.

The parts warranty remains in effect for one (1) year from installation or fifteen (15) months from the shipping date, whichever occurs first.

However, the heating element on Halo Heat<sup>®</sup> cook/hold ovens and the refrigeration compressor on Alto-Shaam Quickchillers<sup>™</sup> are warranted for a period of five (5) years from installation. The labor warranty is the same as stated above; namely, for one (1) year from installation or fifteen (15) months from the shipping date, whichever occurs first.

#### THIS WARRANTY DOES NOT APPLY TO:

1. Calibration.
2. Replacement of light bulbs and/or the replacement of display case glass due to damage of any kind.
3. Equipment damage caused by accident, shipping, improper installation or alteration.
4. Equipment used under conditions of abuse, misuse, carelessness or abnormal conditions including, but not limited to, equipment subjected to harsh or inappropriate chemicals including, but not limited to, compounds containing chloride or quaternary salts, poor water quality, or equipment with missing or altered serial numbers.
5. Damage incurred as a direct result of poor water quality, inadequate maintenance of steam generators and/or surfaces affected by water quality. Water quality and required maintenance of steam generating equipment is the responsibility of the owner/operator.
6. Damage caused by use of any cleaning agent other than Alto-Shaam's Combitherm<sup>®</sup> Cleaner including, but not limited to, damage due to chlorine or other harmful chemicals. Use of Alto-Shaam's Combitherm<sup>®</sup> Cleaner on Combitherm<sup>®</sup> ovens is highly recommended.
7. Any losses or damage resulting from malfunction, including loss of product or consequential or incidental damages of any kind.
8. Equipment modified in any manner from original model, substitution of parts other than factory authorized parts, removal of any parts including legs, or addition of any parts.

This warranty is exclusive and is in lieu of all other warranties, expressed or implied, including the implied warranties of merchantability and fitness for a particular purpose. In no event shall Alto-Shaam be liable for loss of use, loss of revenue or profit, or loss of product, or for any indirect or consequential damages. No person except an officer of Alto-Shaam, Inc. is authorized to modify this warranty or to incur on behalf of Alto-Shaam any other obligation or liability in connection with Alto-Shaam equipment.

**ALTO-SHAAM, INC.**

RECORD THE MODEL AND SERIAL NUMBER OF THE APPLIANCE FOR EASY REFERENCE.  
ALWAYS REFER TO BOTH MODEL AND SERIAL NUMBER IN ANY CONTACT WITH ALTO-SHAAM REGARDING THIS APPLIANCE.

Model: \_\_\_\_\_ Date Installed: \_\_\_\_\_  
Voltage: \_\_\_\_\_ Purchased From: \_\_\_\_\_  
Serial Number: \_\_\_\_\_

**W164 N9221 Water Street • P.O. Box 450 • Menomonee Falls, Wisconsin 53052-0450 • U.S.A.**  
PHONE: 262.251.3800 • 800.558-8744 USA/CANADA FAX: 262.251.7067 • 800.329.8744 U.S.A. ONLY  
WEBSITE: [www.alto-shaam.com](http://www.alto-shaam.com)

PRINTED IN U.S.A.