

NOTE #1: ALL NUMBERS IN ( ) = ALTO-SHAAM PART NUMBERS

NOTE #2: SEE DRW. JENG\PRJ\730846\ELEC\CUT SHEET\5005034.XLS FOR WIRE ASSEMBLIES

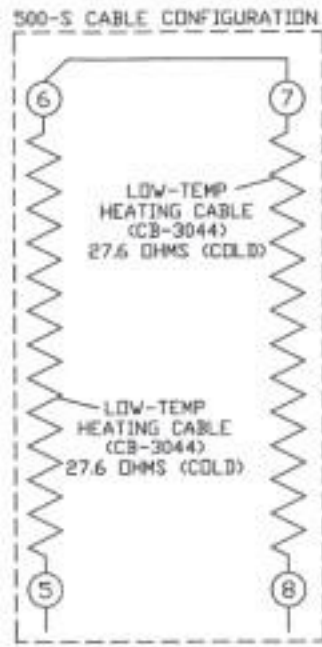

500-S  
 208V, 3.77A, 784W  
 240V, 4.35A, 1044W



750-S  
 208V, 3.99A, 830W  
 240V, 4.61A, 1105W



1000-S  
 208V, 3.85A, 801W  
 240V, 4.44A, 1067W

1200-S 1000W CABLE CONFIGURATION

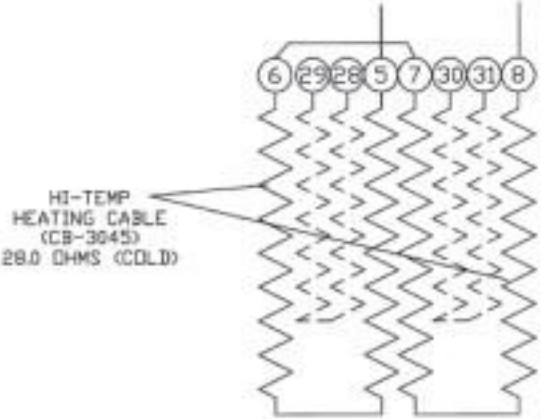

1200-S  
 208V, 3.71A, 772W  
 240V, 4.28A, 1028W

1200-S 2000W CABLE CONFIGURATION

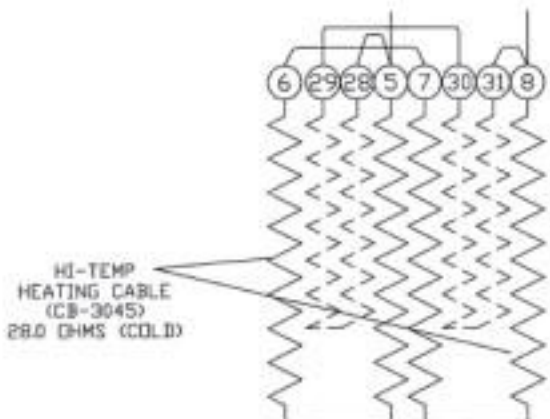

1200-S  
 208V, 7.42A, 1544W  
 240V, 8.56A, 2056W

2000W JUMPER ASSEMBLY 5007692

REV3: FIX ROCKER SWITCH, T-STAT SYMBOL, VERIFY POWER RATINGS  
 REV5: FIXED ROCKER SWITCH AGAIN, ADD CUTSHEET NUMBER, REVERSED BLK AND WHT ON CORD SET. BLK IS ALWAYS ON THE RIGHT, CUT SHEET BLACK AND RED WIRE COLORS WERE REVERSED.  
 REV6: FIX POWER RATINGS

208-240V COMMON WIRE DIAGRAM

MODELS: 500,750,1000,1200-S (UNIBODY)

**ALTO-SHAAM**  
 MENOMONEE FALLS, WISC. 53052-450

NO.	REVISION	BY
1	1-18-07	BT
2	7/19/07	MPB
3	8/10/07	JPK
4	9-13-07	MS
5	8/16/07	JPK
6	8/17/07	JPK

BY: MPB	SCALE: 1"=1'	DWG: B-7853
APP'D: P.E.D.	DATE: 11-13-06	

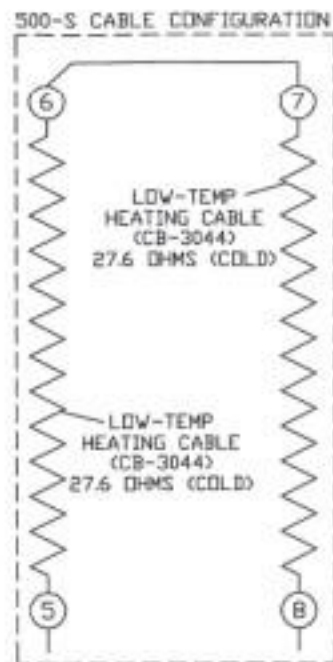
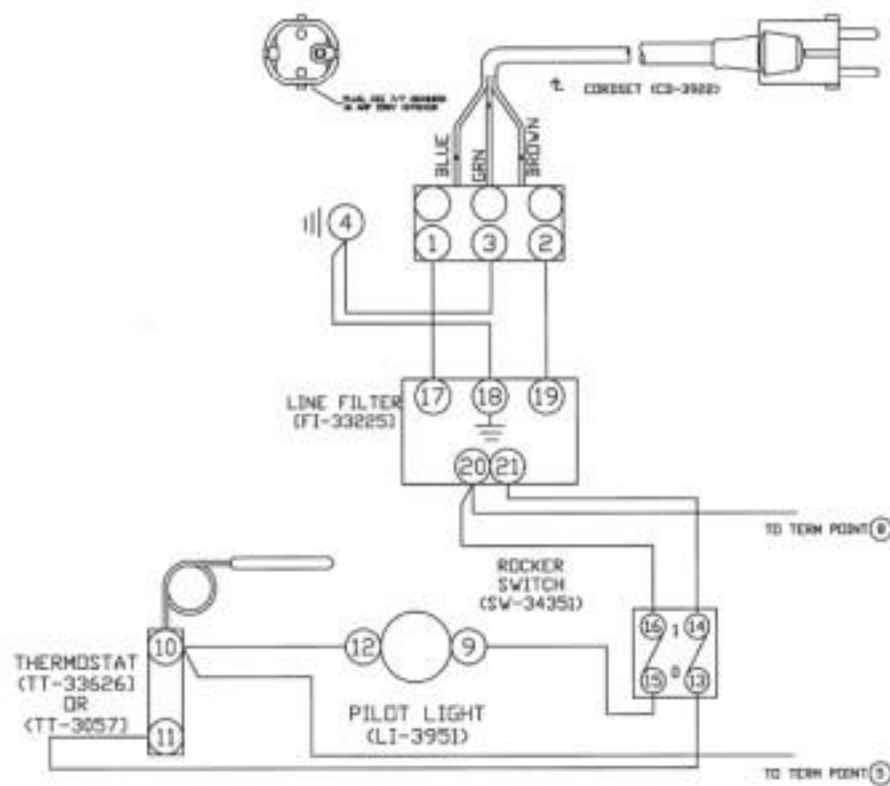

500-S  
230V, 4.17A, 958W

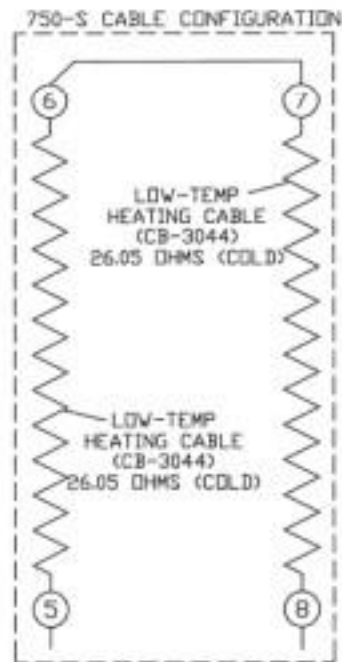

750-S  
230V, 4.41A, 1015W

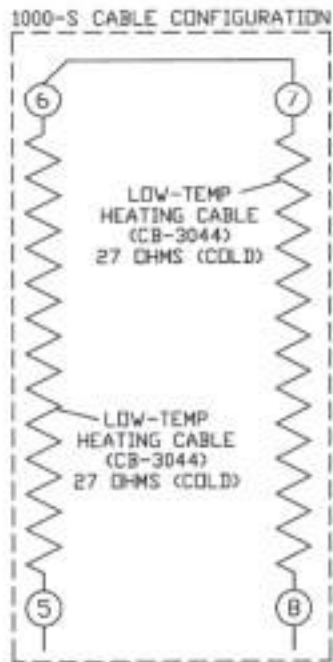

1000-S  
230V, 4.26A, 980W

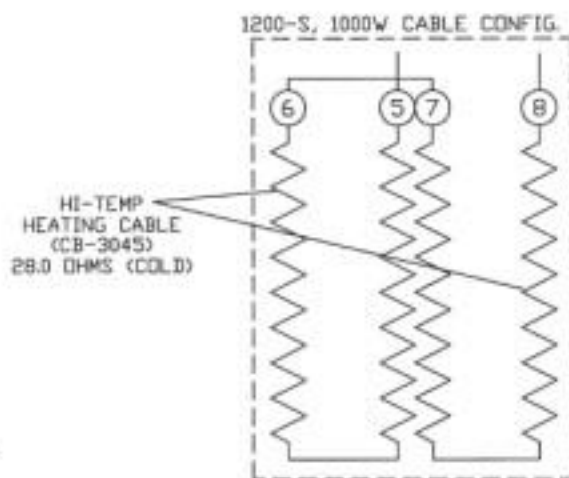

1200-S  
230V, 4.11A, 945W

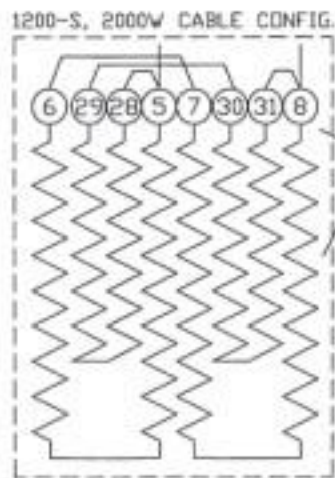

1200-S  
230V, 8.22A, 1890W

2000W JUMPER ASSEMBLY 5007692

HI-TEMP HEATING CABLE  
4 EA (CB-3045)  
28.0 OHMS EA (COLD)  
28.0 OHMS COMBINED RESISTANCE (COLD)  
(SERIES/PARALLEL CONFIG)

- REV0 - CORRECT POWER RATINGS
- REV1 - CHANGE HOW COMMON WIRING CONNECTS TO ALL VARIATIONS (ITEM POINTS 8 AND 20)
- REV2 - FIX ROCKER SWITCH, T-STAT SYMBOL
- REV3 - MAKE SHIELD'S REV4 CHANGES GET LIST, HAD TO FIX ROCKER SW, OUTSHEET NUMBER
- REV4 - MAKE PHASE COLORS MATCH STANDARD, THEY WERE WRONG
- REV5 - FIX POWER RATINGS, PUT UNITS IN ORDER

## 230V COMMON WIRE DIAGRAM

MODELS: 500,750,1000,1200-S (UNIBODY)

**ALTO-SHAAM**  
MEMONONEE FALLS, WISC. 53052-450

BY: M S SCALE: 1"=1' DWG: B-7852  
APP'D: P E D DATE: 10-12-06

NOTE #1: ALL NUMBERS IN ( ) = ALTO-SHAAM PART NUMBERS

NOTE #2: SEE DRW. I:\ENG\PRJ\730846\ELEC\CUT SHEET\5007693.XLS FOR WIRE ASSEMBLIES