

# ALTO SHAAM® Food Holding Cabinet

---

## Electric

**Model:**

**500-S SERIES**

**750-S SERIES**

**1000-S SERIES**

**1200-S SERIES**

**Manual Control**

- **INSTALLATION**
- **OPERATION**
- **MAINTENANCE**



**HALO HEAT®**

**24•7**  
Your Service Hotline  
1-800-558-8744

W164 N9221 Water Street • P.O. Box 450 • Menomonee Falls, Wisconsin 53052-0450 U.S.A.

PHONE: 262.251.3800 • 800.558.8744 U.S.A./CANADA

FAX: 262.251.7067 • 800.329.8744 U.S.A. ONLY

WEBSITE: [www.alto-shaam.com](http://www.alto-shaam.com)

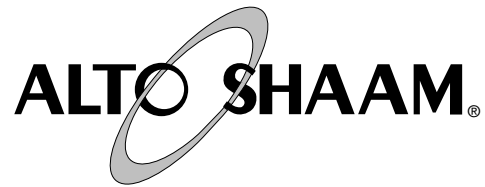

## DELIVERY

This Alto-Shaam appliance has been thoroughly tested and inspected to insure only the highest quality unit is provided. Upon receipt, check for any possible shipping damage and report it at once to the delivering carrier. *See Transportation Damage and Claims section located in this manual.*

This appliance, complete with unattached items and accessories, may have been delivered in one or more packages. Check to ensure that all standard items and options have been received with each model as ordered.

Save all the information and instructions packed with the appliance. Complete and return the warranty card to the factory as soon as possible to assure prompt service in the event of a warranty parts and labor claim.

This manual must be read and understood by all people using or installing the equipment model. Contact the Alto-Shaam service department if you have any questions concerning installation, operation, or maintenance.

**NOTE:** All claims for warranty must include the full model number and serial number of the unit.

## UNPACKING

1. Carefully remove the appliance from the carton or crate.

**NOTE:** Do not discard the carton and other packaging material until you have inspected the unit for hidden damage and tested it for proper operation.

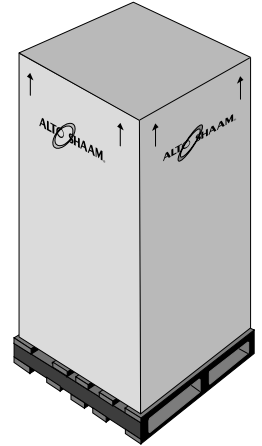

2. Read all instructions in this manual carefully before initiating the installation of this appliance.

### **DO NOT DISCARD THIS MANUAL.**

This manual is considered to be part of the appliance and is to be provided to the owner or manager of the business or to the person responsible for training operators. *Additional manuals are available from the Alto-Shaam service department.*

3. Remove all protective plastic film, packaging materials, and accessories from the appliance before connecting electrical power. Store any accessories in a convenient place for future use.

## SAFETY PROCEDURES AND PRECAUTIONS

Knowledge of proper procedures is essential to the safe operation of electrically and/or gas energized equipment. In accordance with generally accepted product safety labeling guidelines for potential hazards, the following signal words and symbols may be used throughout this manual.

 <b>DANGER</b>	Used to indicate the presence of a hazard that <b>will</b> cause severe personal injury, death, or substantial property damage if the warning included with this symbol is ignored.
---	---

 <b>WARNING</b>	Used to indicate the presence of a hazard that <b>can</b> cause personal injury, possible death, or major property damage if the warning included with this symbol is ignored.
--	--

 <b>CAUTION</b>	Used to indicate the presence of a hazard that can or will cause minor or moderate personal injury or property damage if the warning included with this symbol is ignored.
--	--

<b>CAUTION</b>	Used to indicate the presence of a hazard that can or will cause minor personal injury, property damage, or a potential unsafe practice if the warning included with this symbol is ignored.
----------------	--

<b>NOTE:</b>	Used to notify personnel of installation, operation, or maintenance information that is important but not hazard related.
--------------	---

1. This appliance is intended to cook, hold or process foods for the purpose of human consumption. No other use for this appliance is authorized or recommended.
2. This appliance is intended for use in commercial establishments where all operators are familiar with the purpose, limitations, and associated hazards of this appliance. Operating instructions and warnings must be read and understood by all operators and users.
3. Any troubleshooting guides, component views, and parts lists included in this manual are for general reference only and are intended for use by qualified technical personnel.
4. This manual should be considered a permanent part of this appliance. This manual and all supplied instructions, diagrams, schematics, parts lists, notices, and labels must remain with the appliance if the item is sold or moved to another location.

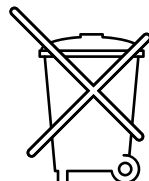
<b>NOTE</b>	
	<b>For equipment delivered for use in any location regulated by the following directive: DO NOT DISPOSE OF ELECTRICAL OR ELECTRONIC EQUIPMENT WITH OTHER MUNICIPAL WASTE.</b>

# INSTALLATION

## SITE INSTALLATION

- The appliance, complete with unattached items and accessories, may be delivered in one or more packages. Check to ensure that the following items have been received as standard with each unit.

500-S: 2 - SIDE RACKS, 3 - WIRE SHELVES, 4 - CASTERS

750-S: 2 - SIDE RACKS, 3 - WIRE SHELVES, 4 - CASTERS

1000-S: 2 - SIDE RACKS, 4 - CASTERS

1200-S: 4 SETS PAN SLIDES, 4 - CASTERS

- This appliance is designed for the purpose of maintaining hot food at a temperature for safe consumption. The unit must be installed on a level surface in a location that will permit the equipment to function for its intended purpose and allow adequate access for proper cleaning and maintenance.
- The appliance must not be installed in any area where it will be affected by steam, grease, dripping water, high temperatures, or any other severely adverse conditions.
- Level the appliance from side-to-side and front-to-back using a spirit level.

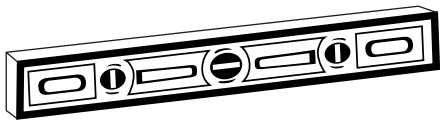

- In order to maintain standards established by the National Sanitation Foundation, all equipment must be equipped with casters or 6" (152mm) legs to provide minimum unobstructed space beneath the unit; or secured flush at the bottom and the entire base sealed with NSF approved sealant. Warranty will become null and void if these directions are not followed.



## CAUTION

TO PREVENT PERSONAL INJURY,  
USE CAUTION WHEN MOVING OR  
LEVELING THIS APPLIANCE.



## DANGER

IMPROPER INSTALLATION, ALTERATION,  
ADJUSTMENT, SERVICE OR MAINTENANCE  
COULD RESULT IN SEVERE INJURY, DEATH  
OR CAUSE PROPERTY DAMAGE.

### CLEARANCE REQUIREMENTS

3-inches (76mm) at the back,  
2-inches (51mm) at the top,  
1-inch (25mm) at both sides

### WEIGHT EST.

	500-S/STD	500-S/HD
<b>NET</b>	94 lb (43 kg)	104 lb (47 kg)
<b>SHIP</b>	120 lb (54 kg)	130 lb (59 kg)
<b>CARTON DIMENSIONS:</b> 40" x 20" x 30" EST.		
(H x W x D)	(1015mm x 508mm x 762mm)	

### WEIGHT

	750-S/STD	750-S/HD
<b>NET</b>	152 lb (69 kg)	162 lb (73 kg)
<b>SHIP</b>	193 lb (88 kg)	203 lb (92 kg)
<b>CARTON DIMENSIONS:</b> 40" x 28" x 34" EST.		
(H x W x D)	(1015mm x 686mm x 889mm)	

### WEIGHT (EST.)

	1000-S/STD	1000-S/HD
<b>NET</b>	138 lb (63 kg)	150 lb (68 kg)
<b>SHIP</b>	163 lb (74 kg)	180 lb (82 kg)
<b>CARTON DIMENSIONS:</b> 45" x 27" x 35" EST.		
(H x W x D)	(1143mm x 686mm x 889mm)	

### WEIGHT (EST.)

	1200-S/STD	1200-S/HD
<b>NET</b>	165 lb (75 kg)	180 lb (82 kg)
<b>SHIP</b>	163 lb (74 kg)	180 lb (82 kg)
<b>CARTON DIMENSIONS:</b> 48" x 33" x 36" EST.		
(H x W x D)	(1219mm x 838mm x 914mm)	

# INSTALLATION

## SITE INSTALLATION

### STACKING INSTRUCTIONS

- 1) If the two appliances were shipped together from the factory, the top unit will have the casters already removed. A stacking kit will be included with the shipment.

If casters need to be removed: lay the unit on its back, and remove the set screw on each caster. Pull the casters out of the unit.

- 2) While appliance is laid on its back, insert one stacking post in each of the four corners of the upper unit. Secure the stacking posts using one screw and two flat washers that come with the stacking kit.

**Note:** The flange on the stacking posts must face the outside of the unit.

- 3) Remove the four top mounting screws from the lower unit. Place the upper appliance, which has the stacking posts installed, on top of the bottom unit. Center the top unit from front to back. Re-install the four screws through the flange of the four stacking posts.

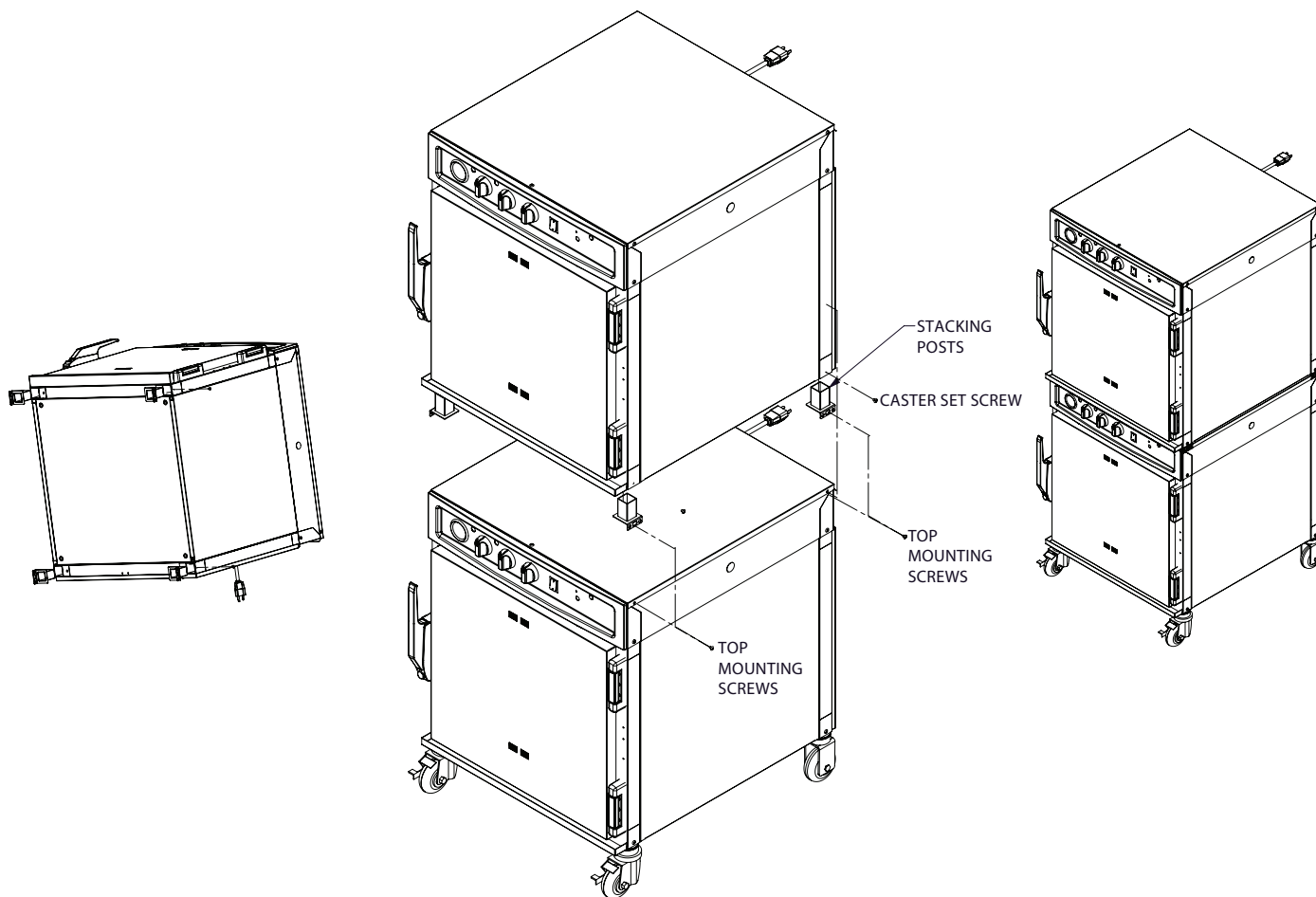

#### Stacking Configurations

- 1200-S with 1200-S
- 1000-S with 1000-S, 1000-TH/III, or 1000-TH-II/Split
- 750-S with 750-S, 750-TH-II, 750-TH-III, 767-SK, 767-SK/III
- 500-S with 500-S, 500-TH-II, 500-TH-III

# INSTALLATION

## EXTERIOR DIMENSIONS - 500-S SERIES

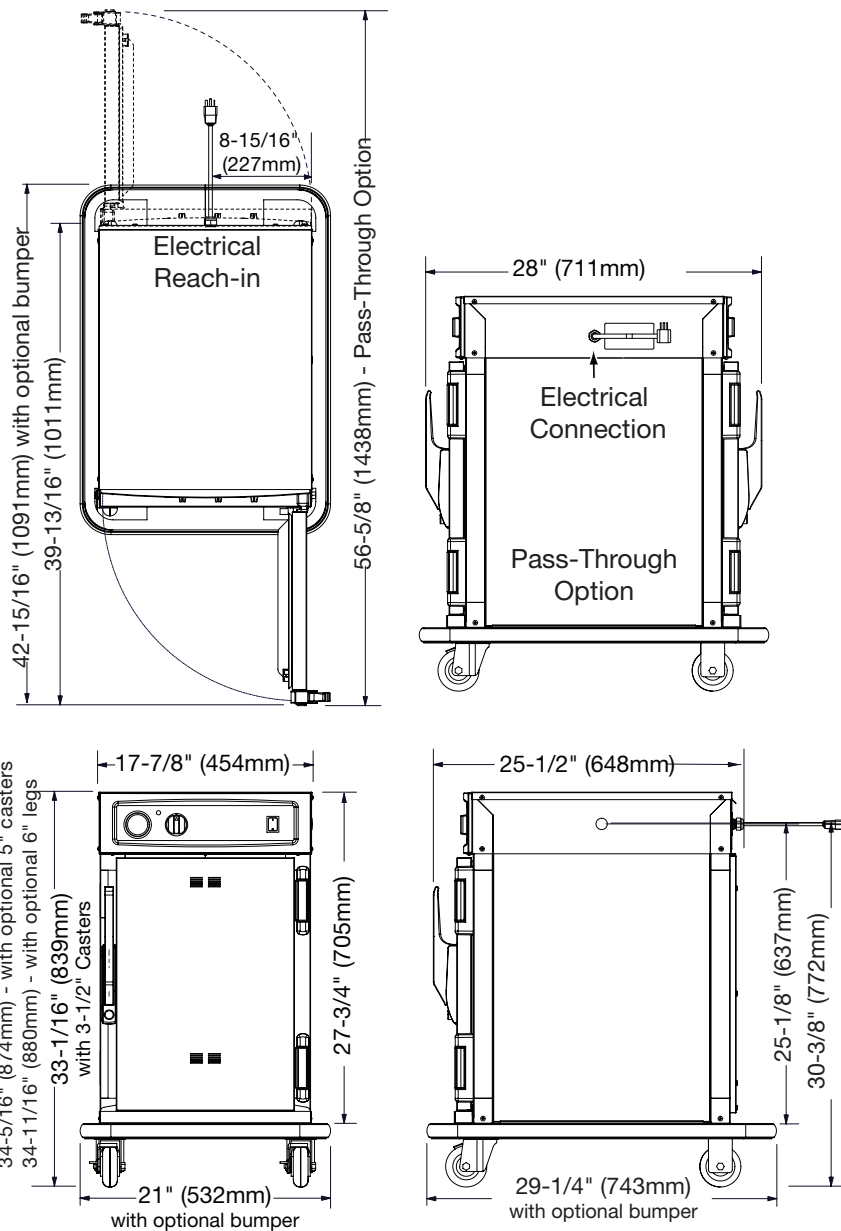

### OPTIONS & ACCESSORIES

Bumper, Full Perimeter, for cabinet	<a href="#">5006782</a>	HACCP Network Options (ELECTRONIC CONTROL ONLY) <b>REFER TO SPECIFICATION #9015 FOR APPLICABLE PART NUMBERS</b>
Casters, 5" (127mm) Stem, 2 RIGID, 2 SWIVEL W/BRAKE	<a href="#">5004862</a>	
Cutting Board, 18" x 12" x 1/2" (457 x 305 x 13mm)	BA-2358	<ul style="list-style-type: none"> <li>➤ HACCP Documentation</li> <li>➤ HACCP with Kitchen Management</li> </ul>
Door Lock with Key	<a href="#">LK-22567</a>	Probe, Internal Temperature (ELECTRONIC CONTROL)      AVAILABLE
Drip Pan, 1" (25mm) deep	<a href="#">PN-2122</a>	Shelf, Chrome Wire <a href="#">SH-2107</a>
Drip Tray - External	<a href="#">1007267</a>	Shelf, Stainless Steel, Flat Wire <a href="#">SH-2326</a>
Legs, 6" (152mm), Flanged (SET OF FOUR)	<a href="#">5004863</a>	Side Rack (230V MODELS ONLY)      SR-2386

# INSTALLATION

## EXTERIOR DIMENSIONS - 750-S SERIES

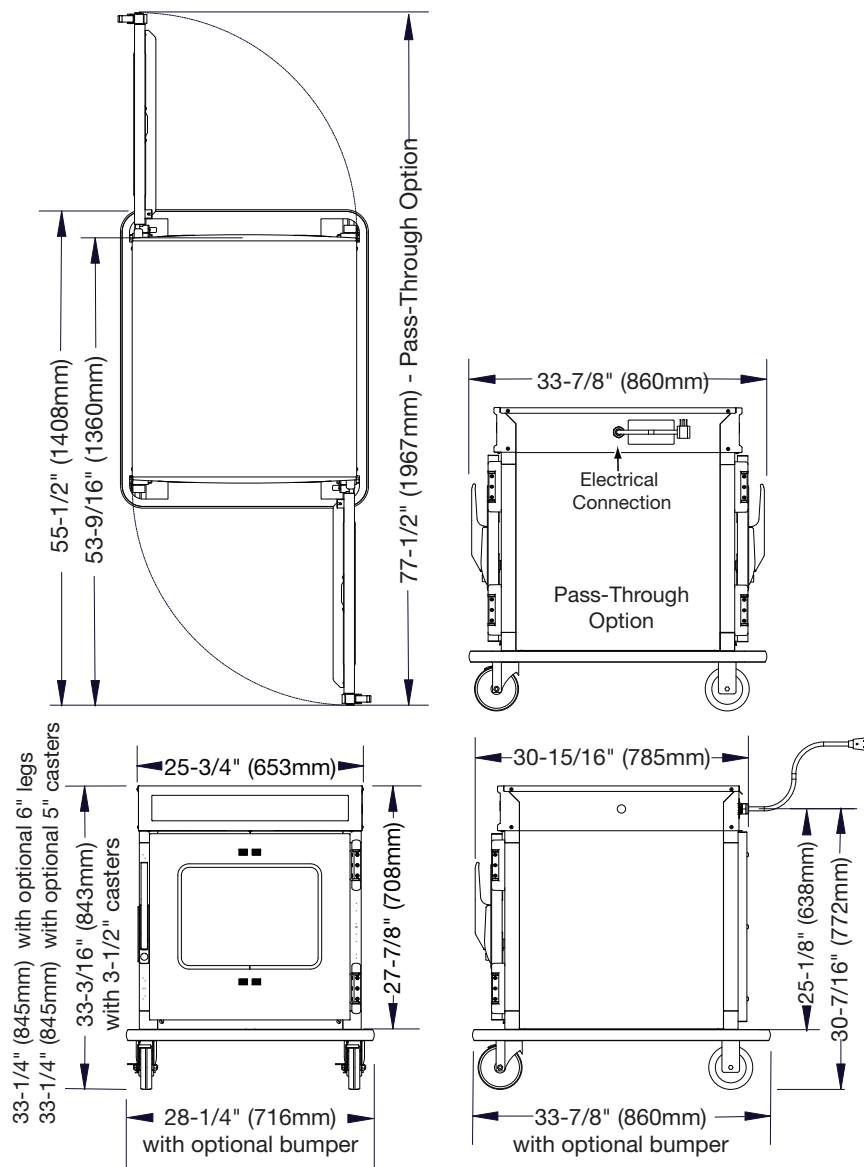

### OPTIONS & ACCESSORIES

Bumper for cabinet, FULL PERIMETER	5004861	HACCP Network Options (ELECTRONIC CONTROL ONLY)	
Carving Holder, Prime Rib	HL-2635	<b>REFER TO SPECIFICATION #9015 FOR APPLICABLE PART NUMBERS</b>	
Carving Holder, Steamship (Cafeteria) Round	4459	➔ HACCP Documentation	
Casters, 5" (127mm) Stem, 2 RIGID, 2 SWIVEL W/BRAKE	5004862	➔ HACCP with Kitchen Management	
Cutting Board, 18" x 24" x 1/2" (457 x 610 x 13mm)	BA-2054	Probe, Internal Temperature (ELECTRONIC CONTROL)	AVAILABLE
Door Lock with Key	LK-22567	Security Panel	5004750
Drip Pan, with Drain	14831	Shelf, Chrome Wire, REACH-IN	SH-2105
Drip Tray - External	5004975	Shelf, Chrome Wire, PASS-THROUGH	SH-2327
Legs, 6" (152mm), Flanged (SET OF FOUR)	5004863	Shelf, Stainless Steel, Flat Wire, REACH-IN	SH-2324
Pan Grid, Wire - 18" x 26" PAN INSERT	PN-2115	Shelf, Stainless Steel, Rib Rack	SH-2743
		Side Rack (230V MODELS ONLY)	SR-27426

# INSTALLATION

## EXTERIOR DIMENSIONS - 1000-S SERIES

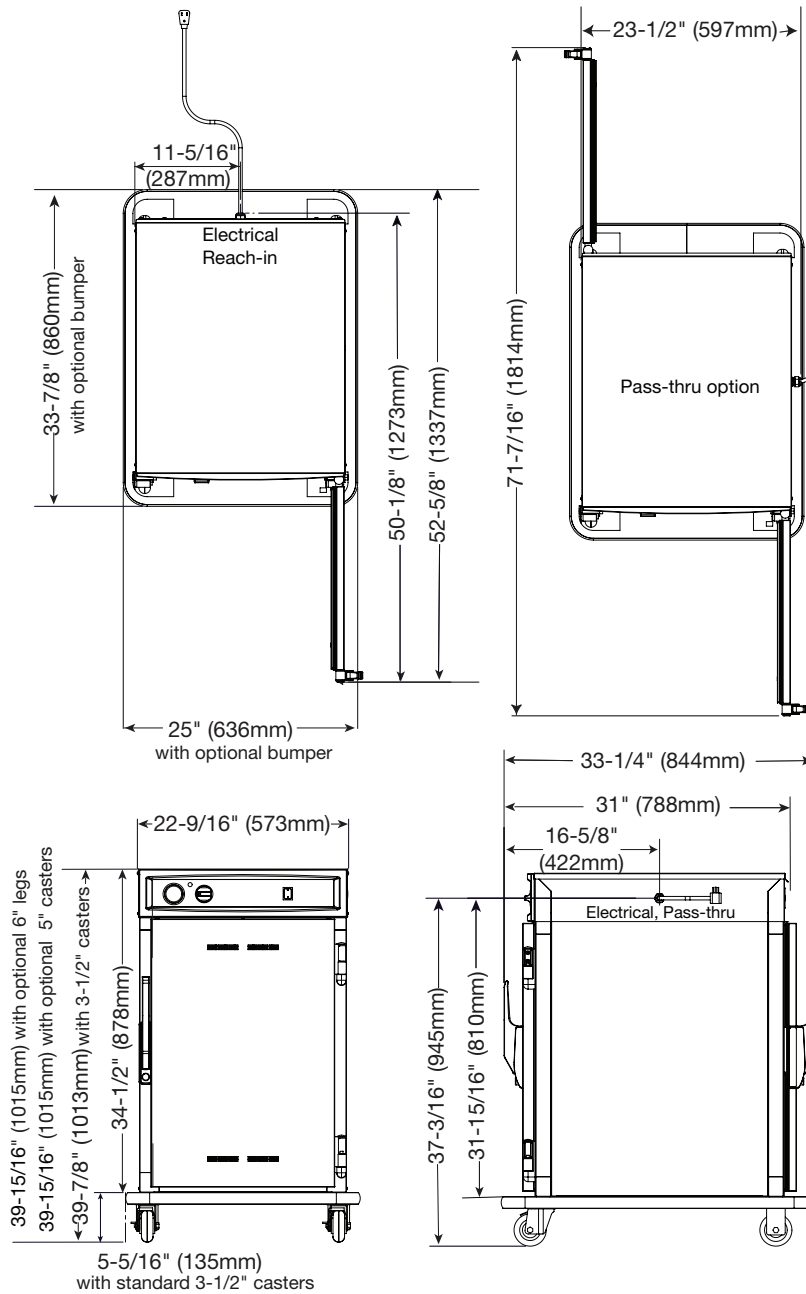

### OPTIONS & ACCESSORIES

Bumper, FULL PERIMETER	<a href="#">5005103</a>	<b>HACCP Network Options (ELECTRONIC CONTROL ONLY)</b> <b>REFER TO SPECIFICATION #9015 FOR APPLICABLE PART NUMBERS</b> <ul style="list-style-type: none"> <li>➤ HACCP Documentation</li> <li>➤ HACCP with Kitchen Management</li> </ul>
Casters, 5" (127mm) Stem, 2 RIGID, 2 SWIVEL W/BRAKE	<a href="#">5004862</a>	
Door Lock with Key	<a href="#">LK-22567</a>	
Drip Pan, without Drain	<a href="#">11906</a>	
Drip Pan, extra Deep	<a href="#">1115</a>	
Legs, 6" (152mm) Flanged (SET OF FOUR)	<a href="#">5004863</a>	
Pan Grid, Wire, - 18" x 26" PAN INSERT	<a href="#">PN-2115</a>	
Probe, Internal Temperature (ELECTRONIC CONTROL)	AVAILABLE	<a href="#">SH-2325</a> <a href="#">SH-2346</a> <a href="#">5004864</a> <a href="#">1775</a> <a href="#">1774</a>
		<a href="#">SH-2325</a> <a href="#">SH-2346</a> <a href="#">5004864</a> <a href="#">1775</a> <a href="#">1774</a>

# INSTALLATION

## EXTERIOR DIMENSIONS - 1200-S SERIES

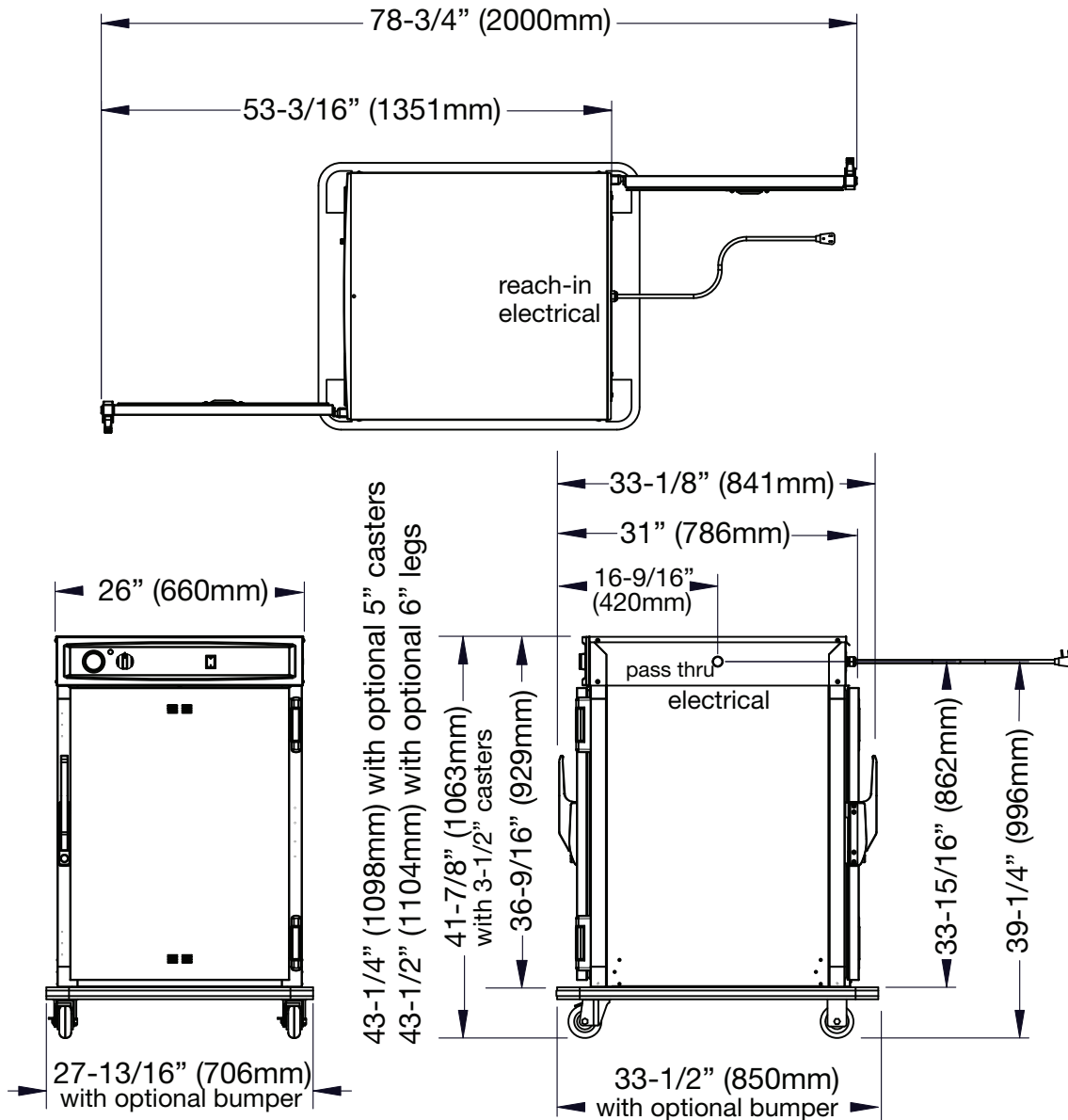

### OPTIONS & ACCESSORIES

Bumper, Full Perimeter	5004861	Universal Angle Configuration	
Casters, 5" (127mm) Stem, 2 RIGID, 2 SWIVEL W/BRAKE	5004862	➤ Pan Slides, Chrome Plated	SR-24447
Door Lock with Key	LK-22567	➤ Pan Slides, Stainless Steel	SR-24762
HACCP Network Options (ELECTRONIC CONTROL ONLY) REFER TO SPECIFICATION #9015 FOR APPLICABLE PART NUMBERS		Side Rack Configuration	
➤ HACCP Documentation		➤ Side Rack, Chrome Plated	SR-22445
➤ HACCP with Kitchen Management		➤ Side Rack, Stainless Steel	SR-23739
Legs, 6" (152mm) Flanged (SET OF FOUR)	5004863	➤ Shelf, Stainless Steel	SH-23738
Pan Grid, chrome plated, wire	PN-2115	➤ Shelf, Chrome Plated	SH-2733
➤ Sheet pan insert 18" x 26" (457mm x 660mm x 25mm)		Stacking Hardware	5004864
Probe, Internal Temperature (ELECTRONIC CONTROL) AVAILABLE		Water Reservoir Pan	1775
		Water Reservoir Pan Cover	1774

# INSTALLATION

## SITE INSTALLATION

### DRIP TRAY INSTALLATION INSTRUCTIONS

**STANDARD DRIP PAN\***  
[BOTTOM OF OVEN INTERIOR  
• BELOW SIDE-RACKS]

**HANG DRIP TRAY ON SCREWS**

**DRIP  
TRAY\***



**\*SEE ALTO-SHAAM PARTS LIST FOR ALTO-SHAAM PART NUMBERS.**

# INSTALLATION

## ELECTRICAL



1. An identification tag is permanently mounted on the cabinet.
2. Plug cabinet into a properly grounded receptacle ONLY, positioning the unit so the power supply cord is easily accessible in case of an emergency.  
Arcing will occur when connecting or disconnecting the unit unless all controls are in the "OFF" position.
3. If necessary, a proper receptacle or outlet configuration as required for this unit, must be installed by a licensed electrician in accordance with applicable, local electrical codes.



### For 230V:



To prevent an electrical shock hazard between the appliance and other appliances or metal parts in close vicinity, an equalization-bonding stud is provided. An equalization bonding lead must be connected to this stud and the other appliances / metal parts to provide sufficient protection against potential difference. The terminal is marked with the following symbol. 



### NOTE:

The appliance must be connected to an electrical circuit that is protected by an external GFCI outlet.

ELECTRICAL • 500-S SERIES							
	VOLTAGE	PHASE	CYCLE/HZ	AMPS	kW	CORD & PLUG INCLUDED	
120	at 120	1	50/60	8.7	1.04		NEMA 5-15P, 15A-125V PLUG
208-240	at 208	1	50/60	3.77	0.78		NEMA 6-15P,
	at 240	1	50/60	4.35	1.04		15A-250V PLUG (USA ONLY)
230	at 230	1	50/60	4.17	0.958		CEE 7/7, 220-230V PLUG

ELECTRICAL • 750-S SERIES							
	VOLTAGE	PHASE	CYCLE/HZ	AMPS	kW	CORD & PLUG INCLUDED	
120	at 120	1	60	9.2	1.11		NEMA 5-15P, 15A-125V PLUG
208-240	at 208	1	50/60	3.99	0.83		NEMA 6-15P,
	at 240	1	50/60	4.61	1.10		15A-250V PLUG (USA ONLY)
230	at 230	1	50/60	4.41	1.02		CEE 7/7, 220-230V PLUG

ELECTRICAL • 1000-S SERIES							
	VOLTAGE	PHASE	CYCLE/HZ	AMPS	kW	CORD & PLUG INCLUDED	
120	at 120	1	60	8.6	1.04		NEMA 5-15P, 15A-125V PLUG
208-240	at 208	1	50/60	3.9	0.82		NEMA 6-15P,
	at 240	1	50/60	4.5	1.1		15A-250V PLUG (USA ONLY)
230	at 230	1	50/60	4.1	0.95		CEE 7/7, 220-230V PLUG

ELECTRICAL • 1200-S SERIES							
	VOLTAGE	PHASE	CYCLE/HZ	AMPS	kW	CORD & PLUG INCLUDED	
120	at 120	1	60	8.6	1.02		NEMA 5-15P, 15A-125V PLUG
208-240	at 208	1	50/60	3.7	0.77		NEMA 6-15P,
	at 240	1	50/60	4.2	1.02		15A-250V PLUG (USA ONLY)
230	at 230	1	50/60	4.1	0.94		CEE 7/7, 220-230V PLUG





## DANGER

ELECTRICAL CONNECTIONS MUST BE MADE BY A QUALIFIED SERVICE TECHNICIAN IN ACCORDANCE WITH APPLICABLE ELECTRICAL CODES.





## DANGER

ENSURE POWER SOURCE MATCHES VOLTAGE STAMPED ON APPLIANCE NAMEPLATE





## DANGER

To avoid electrical shock, this appliance **MUST** be adequately grounded in accordance with local electrical codes or, in the absence of local codes, with the current edition of the National Electrical Code ANSI/NFPA No. 70. In Canada, all electrical connections are to be made in accordance with CSA C22.1, Canadian Electrical Code Part 1 or local codes.

# INSTALLATION

## USER SAFETY INFORMATION

This appliance is intended for use in commercial establishments where all operators are familiar with the purpose, limitations, and associated hazards of this appliance. Operating instructions and warnings must be read and understood by all operators and users.

1. Unit must be connected to the appropriate power source.
2. Use hand protection when handling hot items.
3. Preheat the unit for 30 minutes before use.
4. Be certain only hot foods are placed into the unit.

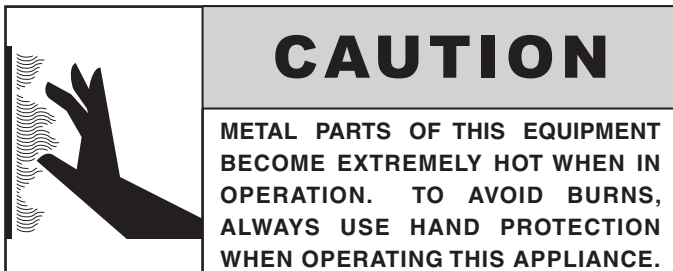

### BEFORE INITIAL USE:

1. Clean both the interior and exterior of the unit with a damp, clean cloth and mild soap solution. Rinse carefully.
2. Clean and install the cabinet side racks. Shelves should be positioned with the curved end up and toward the back of the unit (reach-in models).

### HEATING CHARACTERISTICS

The cabinet is equipped with a special heating cable. Through this Halo Heat concept, the heating cable is mounted against the walls of the unit to provide an evenly applied heat source controlled by a thermostat. The design and operational characteristics of the unit eliminate the need for a moisture pan or a heat circulating fan. Through even heat application, the quality of food products is maintained up to several hours or more.

PRODUCT\PAN CAPACITY - 500-S SERIES	
60 lbs (27 kg) MAXIMUM	
VOLUME MAXIMUM: 50 QUARTS (47.5 LITERS)	
<b>FULL-SIZE PANS:</b>	<b>GASTRONORM 1/1:</b>
Five (5) 20" x 12" x 2-1/2"	530mm x 325mm x 65mm
Four (4) 20" x 12" x 4"	530mm x 325mm x 100mm
<b>HALF-SIZE PANS:</b>	<b>GASTRONORM 1/2:</b>
Ten (10) 10" x 12" x 2-1/2"	265mm x 325mm x 65mm
Eight (8) 10" x 12" x 4"	265mm x 325mm x 100mm

PRODUCT\PAN CAPACITY - 750-S SERIES	
120 lbs (54 kg) MAXIMUM	
VOLUME MAXIMUM: 100 QUARTS (95 LITERS)	
<b>FULL-SIZE PANS:</b>	<b>GASTRONORM 1/1:</b>
Ten (10) 20" x 12" x 2-1/2"	(530mm x 325mm x 65mm)
Six (6) 20" x 12" x 4"	(530mm x 325mm x 100mm)
Four (4) 20" x 12" x 6"	(530mm x 325mm x 150mm)
<b>FULL-SIZE SHEET PANS (ON WIRE SHELVES ONLY):</b>	
Up to Five (5) 18" x 26" x 1" - WITH ADDITIONAL WIRE SHELVES	

PRODUCT\PAN CAPACITY - 1000-S SERIES	
120 lbs (54kg) MAXIMUM	
VOLUME MAXIMUM: 60 QUARTS (76 LITERS)	
<b>FULL-SIZE PANS:</b>	<b>GASTRONORM 1/1:</b>
Eight (8) 20" x 12" x 2-1/2"	(530mm x 325mm x 65mm)
<b>FULL-SIZE SHEET PANS:</b>	
Eight (8) 18" x 26" x 1"	

PRODUCT\PAN CAPACITY - 1200-S SERIES	
192 lbs (87 kg) MAXIMUM	
VOLUME MAXIMUM: 120 QUARTS (152 LITERS)	
<b>—WITH PAN SLIDES PROVIDED: —WITH ADD'L PAN SLIDES:</b>	
<b>FULL-SIZE PANS:</b>	<b>GASTRONORM 1/1:</b>
Eight (8) 20" x 12" x 2-1/2"	(530mm x 325mm x 65mm)
	up to 16 Pans
Eight (8) 20" x 12" x 4"	(530mm x 325mm x 100mm)
	up to 10 Pans
Eight (8) 20" x 12" x 6"	(530mm x 325mm x 150mm)
<b>FULL-SIZE SHEET PANS:</b>	
Four (4) 18" x 26" x 1"	up to 16 Pans
Universal pan slides - 1-3/4" (44mm) centers	
<b>—WITH OPTIONAL SIDE RACKS FOR SHELVES</b>	
<b>FULL-SIZE PANS</b>	<b>GASTRONORM 1/1:</b>
Sixteen (16) 20" x 12" x 2-1/2"	(530mm x 325mm x 65mm)
Ten (10) 20" x 12" x 4"	(530mm x 325mm x 100mm)
Eight (8) 20" x 12" x 6"	(530mm x 325mm x 150mm)

# OPERATION

## MANUAL CONTROL

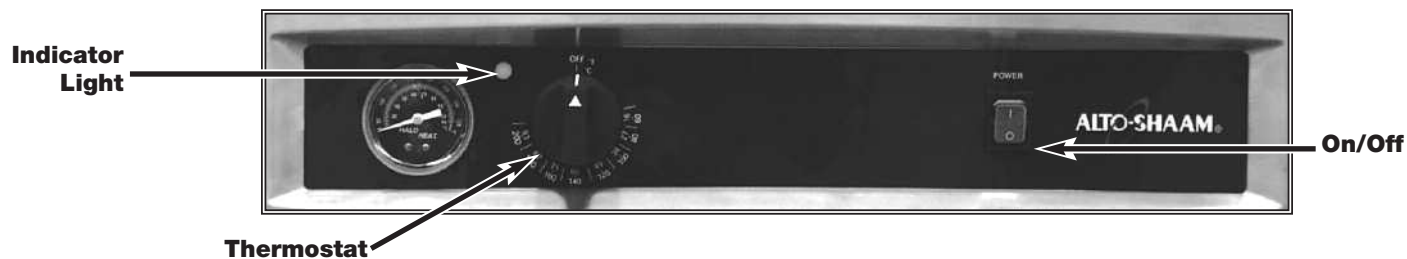

### 1. Preheat at 200°F (93°C) for 30 minutes.

Press the ON key. The ON key will illuminate. Turn the thermostat clockwise; the indicator light will illuminate and will remain lit as long as the unit is calling for heat. Closing the vents on the inside of the door will speed up the process. Allow a minimum of 30 minutes of preheating before loading the holding cabinet with food. The indicator light will go OUT after approximately 30 minutes, or when the air temperature inside the unit reaches the temperature set by the operator.

### 2. Load the cabinet with hot food only.

The purpose of the holding cabinet is to maintain hot food at proper serving temperatures. Only hot food should be placed into the cabinet. Before loading the unit with food, use a food thermometer to make certain all food products are at an internal temperature range of 140° to 160°F (60° to 71°C). All food not within the proper temperature range should be heated before loading into the holding cabinet.

### 3. Reset the thermostat to 160°F (71°C).

Check to make certain the cabinet door is securely closed, and reset the thermostat to 160°F (71°C).

THIS WILL NOT NECESSARILY BE THE FINAL SETTING.

The proper temperature range for the food being held will depend on the type and quantity of product. Whether or not the door vents should be open or closed will also depend on the type of food being held. When holding food for prolonged periods, it is advisable to periodically check the internal temperature of each item to assure maintenance of the proper temperature range.

# OPERATION

## GENERAL HOLDING GUIDELINES

Chefs, cooks and other specialized food service personnel employ varied methods of cooking. Proper holding temperatures for a specific food product must be based on the moisture content of the product, product density, volume, and proper serving temperatures. Safe holding temperatures must also be correlated with palatability in determining the length of holding time for a specific product.

Halo Heat maintains the maximum amount of product moisture content without the addition of water, water vapor, or steam. Maintaining maximum natural product moisture preserves the natural flavor of the product and provides a more genuine taste. In addition to product moisture retention, the gentle properties of Halo Heat maintain a consistent temperature throughout the cabinet without the necessity of a heat distribution fan, thereby preventing further moisture loss due to evaporation or dehydration.

When product is removed from a high temperature cooking environment for immediate transfer into equipment with the lower temperature required for hot food holding, condensation can form on the outside of the product and on the inside of plastic containers used in self-service applications. Allowing the product to release the initial steam and heat produced by high temperature cooking can alleviate this condition. To preserve the safety and quality of freshly cooked foods however, a maximum of 1 to 2 minutes must be the only time period allowed for the initial heat to be released from the product.

Most Halo Heat holding equipment is provided with a thermostat control between 60° and 200°F (16° to 93°C). If the unit is equipped with vents, close the vents for moist holding and open the vents for crisp holding.

If the unit is equipped with a thermostat indicating a range of between 1 and 10, use a metal-stemmed indicating thermometer to measure the internal temperature of the product(s) being held. Adjust the thermostat setting to achieve the best overall setting based on internal product temperature.

<b>HOLDING TEMPERATURE RANGE</b>		
<b>MEAT</b>	<b>FAHRENHEIT</b>	<b>CELSIUS</b>
BEEF ROAST — Rare	140°F	60°C
BEEF ROAST — Med/Well Done	160°F	71°C
BEEF BRISKET	160° — 175°F	71° — 79°C
CORN BEEF	160° — 175°F	71° — 79°C
PASTRAMI	160° — 175°F	71° — 79°C
PRIME RIB — Rare	140°F	60°C
STEAKS — Broiled/Fried	140° — 160°F	60° — 71°C
RIBS — Beef or Pork	160°F	71°C
VEAL	160° — 175°F	71° — 79°C
HAM	160° — 175°F	71° — 79°C
PORK	160° — 175°F	71° — 79°C
LAMB	160° — 175°F	71° — 79°C
<b>POULTRY</b>		
CHICKEN — Fried/Baked	160° — 175°F	71° — 79°C
DUCK	160° — 175°F	71° — 79°C
TURKEY	160° — 175°F	71° — 79°C
GENERAL	160° — 175°F	71° — 79°C
<b>FISH/SEAFOOD</b>		
FISH — Baked/Fried	160° — 175°F	71° — 79°C
LOBSTER	160° — 175°F	71° — 79°C
SHRIMP — Fried	160° — 175°F	71° — 79°C
<b>BAKED GOODS</b>		
BREADS/ROLLS	120° — 140°F	49° — 60°C
<b>MISCELLANEOUS</b>		
CASSEROLES	160° — 175°F	71° — 79°C
DOUGH — Proofing	80° — 100°F	27° — 38°C
EGGS — Fried	150° — 160°F	66° — 71°C
FROZEN ENTREES	160° — 175°F	71° — 79°C
HORS D'OEUVRES	160° — 180°F	71° — 82°C
PASTA	160° — 180°F	71° — 82°C
PIZZA	160° — 180°F	71° — 82°C
POTATOES	180°F	82°C
PLATED MEALS	180°F	82°C
SAUCES	140° — 200°F	60° — 93°C
SOUP	140° — 200°F	60° — 93°C
VEGETABLES	160° — 175°F	71° — 79°C
The holding temperatures listed are suggested guidelines only.		

# CARE AND CLEANING

## CLEANING AND PREVENTIVE MAINTENANCE

### PROTECTING STAINLESS STEEL SURFACES



It is important to guard against corrosion in the care of stainless steel surfaces. Harsh, corrosive, or inappropriate chemicals can completely destroy the protective surface layer of stainless steel. Abrasive pads, steel wool, or metal implements will abrade surfaces causing damage to this protective coating and will eventually result in areas of corrosion. Even water, particularly hard water that contains high to moderate concentrations of chloride, will cause oxidation and pitting that result in rust and corrosion. In addition, many acidic foods spilled and left to remain on metal surfaces are contributing factors that will corrode surfaces.

Proper cleaning agents, materials, and methods are vital to maintaining the appearance and life of this appliance. Spilled foods should be removed and the area wiped as soon as possible but at the very least, a minimum of once a day. Always thoroughly rinse surfaces after using a cleaning agent and wipe standing water as quickly as possible after rinsing.

### CLEANING AGENTS

Use non-abrasive cleaning products designed for use on stainless steel surfaces. Cleaning agents must be chloride-free compounds and must not contain quaternary salts. Never use hydrochloric acid (muriatic acid) on stainless steel surfaces. Always use the proper cleaning agent at the manufacturer's recommended strength. Contact your local cleaning supplier for product recommendations.

### CLEANING MATERIALS

The cleaning function can usually be accomplished with the proper cleaning agent and a soft, clean cloth. When more aggressive methods must be employed, use a non-abrasive scouring pad on difficult areas and make certain to scrub with the visible grain of surface metal to avoid surface scratches. Never use wire brushes, metal scouring pads, or scrapers to remove food residue.

	<p><b>CAUTION</b></p> <p>TO PROTECT STAINLESS STEEL SURFACES, COMPLETELY AVOID THE USE OF ABRASIVE CLEANING COMPOUNDS, CHLORIDE BASED CLEANERS, OR CLEANERS CONTAINING QUATERNARY SALTS. NEVER USE HYDROCHLORIC ACID (MURIATIC ACID) ON STAINLESS STEEL. NEVER USE WIRE BRUSHES, METAL SCOURING PADS OR SCRAPERS.</p>
--	---

# CARE AND CLEANING



The cleanliness and appearance of this unit will contribute considerably to operating efficiency and savory, appetizing food. Good equipment kept clean works better and lasts longer.



## THOROUGHLY CLEAN THE UNIT DAILY

1. Disconnect unit from power source, and let cool.
2. Remove all detachable items such as shelves, side racks, and drip pan. Clean these items separately with a good grease solvent or commercial detergent. Rinse well and dry.
3. Clean interior metal surfaces of the unit with a damp, clean cloth and any good commercial detergent or grease solvent at the recommended strength. Spray heavily soiled areas with a water soluble degreaser and let stand for 10 minutes, then remove soil with a plastic scouring pad. Rinse by wiping with a sponge and clean warm water to remove all residue. Remove excess water with sponge and wipe dry with a clean cloth or air dry. Replace side racks and shelves.
4. Clean control panel, door vents, door handles, and door gaskets thoroughly since these areas harbor food debris. Rinse by wiping with sponge and clean warm water. Wipe dry with a clean cloth.
5. Interior can be wiped with a sanitizing solution after cleaning and rinsing. This solution must be approved for use on stainless steel food contact surfaces.
6. To help maintain the protective film coating on polished stainless steel, clean the exterior of the unit with a cleaner recommended for stainless steel surfaces. Spray the cleaning agent on a clean cloth and wipe with the grain of the stainless steel.



Always follow appropriate state or local health (hygiene) regulations regarding all applicable cleaning and sanitation requirements for foodservice equipment.

**NOTE:** Avoid the use of abrasive cleaning, compounds, chloride based cleaners, or cleaners containing quaternary salts. Never use hydrochloric acid (muriatic acid) on stainless steel.



# SANITATION

Food flavor and aroma are usually so closely related that it is difficult, if not impossible, to separate them. There is also an important, inseparable relationship between cleanliness and food flavor. Cleanliness, top operating efficiency, and appearance of equipment contribute considerably to savory, appetizing foods. Good equipment that is kept clean, works better and lasts longer.

Most food imparts its own particular aroma and many foods also absorb existing odors. Unfortunately, during this absorption, there is no distinction between GOOD and BAD odors. The majority of objectionable flavors and odors troubling food service operations are caused by bacteria growth. Sourness, rancidity, mustiness, stale or other OFF flavors are usually the result of germ activity.

The easiest way to insure full, natural food flavor is through comprehensive cleanliness. This means good control of both visible soil (dirt) and invisible soil (germs). A thorough approach to sanitation will provide essential cleanliness. It will assure an attractive appearance of equipment, along with maximum efficiency and utility. More importantly, a good sanitation program provides one of the key elements in the prevention of food-borne illnesses.

A controlled holding environment for prepared foods is just one of the important factors involved in the prevention of food-borne illnesses. Temperature monitoring and control during receiving, storage, preparation, and the service of foods are of equal importance.

The most accurate method of measuring safe temperatures of both hot and cold foods is by internal product temperature. A quality thermometer is an effective tool for this purpose, and should be routinely used on all products that require holding at a specific temperature.

A comprehensive sanitation program should focus on the training of staff in basic sanitation procedures. This includes personal hygiene, proper handling of raw foods, cooking to a safe internal product temperature, and the routine monitoring of internal temperatures from receiving through service.

Most food-borne illnesses can be prevented through proper temperature control and a comprehensive program of sanitation. Both these factors are important to build quality service as the foundation of customer satisfaction. Safe food handling practices to prevent food-borne illness is of critical importance to the health and safety of your customers. HACCP, an acronym for Hazard Analysis (at) Critical Control Points, is a quality control program of operating procedures to assure food integrity, quality, and safety. Taking steps necessary to augment food safety practices are both cost effective and relatively simple. While HACCP guidelines go far beyond the scope of this manual, additional information is available by contacting:

**Center for Food Safety and Applied Nutrition  
Food and Drug Administration  
1-888-SAFEFOOD**

INTERNAL FOOD PRODUCT TEMPERATURES		
<b>HOT FOODS</b>		
DANGER ZONE	40° TO 140°F	(4° TO 60°C)
CRITICAL ZONE	70° TO 120°F	(21° TO 49°C)
SAFE ZONE	140° TO 165°F	(60° TO 74°C)
<b>COLD FOODS</b>		
DANGER ZONE	ABOVE 40°F	(ABOVE 4°C)
SAFE ZONE	36°F TO 40°F	(2°C TO 4°C)
<b>FROZEN FOODS</b>		
DANGER ZONE	ABOVE 32°F	(ABOVE 0°C)
CRITICAL ZONE	0° TO 32°F	(-18° TO 0°C)
SAFE ZONE	0°F OR BELOW	(-18°C OR BELOW)

# SERVICE

## MANUAL CONTROL

### THERMOSTAT and HEAT LIGHT SEQUENCE

Whenever the thermostat is turned "ON," the heat indicator light will indicate the power ON/OFF condition of the heating cable, and consequently, the cycling of the cabinet as it maintains the dialed cavity temperature. If the light does not illuminate after normal start-up, the main power source, thermostat, and/or light must be checked. If the warming cabinet does not hold the temperature as dialed, the calibration of the thermostat must be checked. If the warmer fails to heat or heats continuously with the thermostat "OFF," the thermostat must be initially checked for proper operation. If these items are checked and found to be in order, a continuity and resistance check of the heating cable should be made. *SEE CIRCUIT DIAGRAM.*

### THERMOSTAT CALIBRATION

The thermostat is precision calibrated at the factory. Normally, no adjustment or recalibration is necessary unless the thermostat has been mishandled in transit, changed or abused while in service. A thermostat with a sensing bulb operates on hydraulic pressure, consequently, any bending of the bulb results in a change in its volume, and alters the accuracy of the thermostat calibration.

A thermostat should be checked or recalibrated by placing a quality, thermal indicator at the center of an empty holding cavity. **DO NOT CALIBRATE WITH ANY FOOD PRODUCT IN THE CABINET.** The thermostat should be set at 140°F (60°C), and should be allowed to stabilize at that setting for a minimum of one hour. Following temperature stabilization, the center of the thermal swing of the air temperature within the cabinet should approximately coincide with the thermostat dial setting.

If calibration is necessary, the calibration screw should be adjusted with great care. The calibration screw of the thermostat is located in the thermostat dial shaft. With the shaft held stationary, a minute, clockwise motion of the calibration screw appreciably lowers the thermostat setting. A reverse, or counter-clockwise motion appreciably raises the thermostat setting. After achieving the desired cycling of the thermostat, the calibration screw must be sealed. Place a few drops of enamel sealant directly on the calibration screw. *(RED NAIL POLISH OR EQUIVALENT IS ACCEPTABLE.)*



# SERVICE

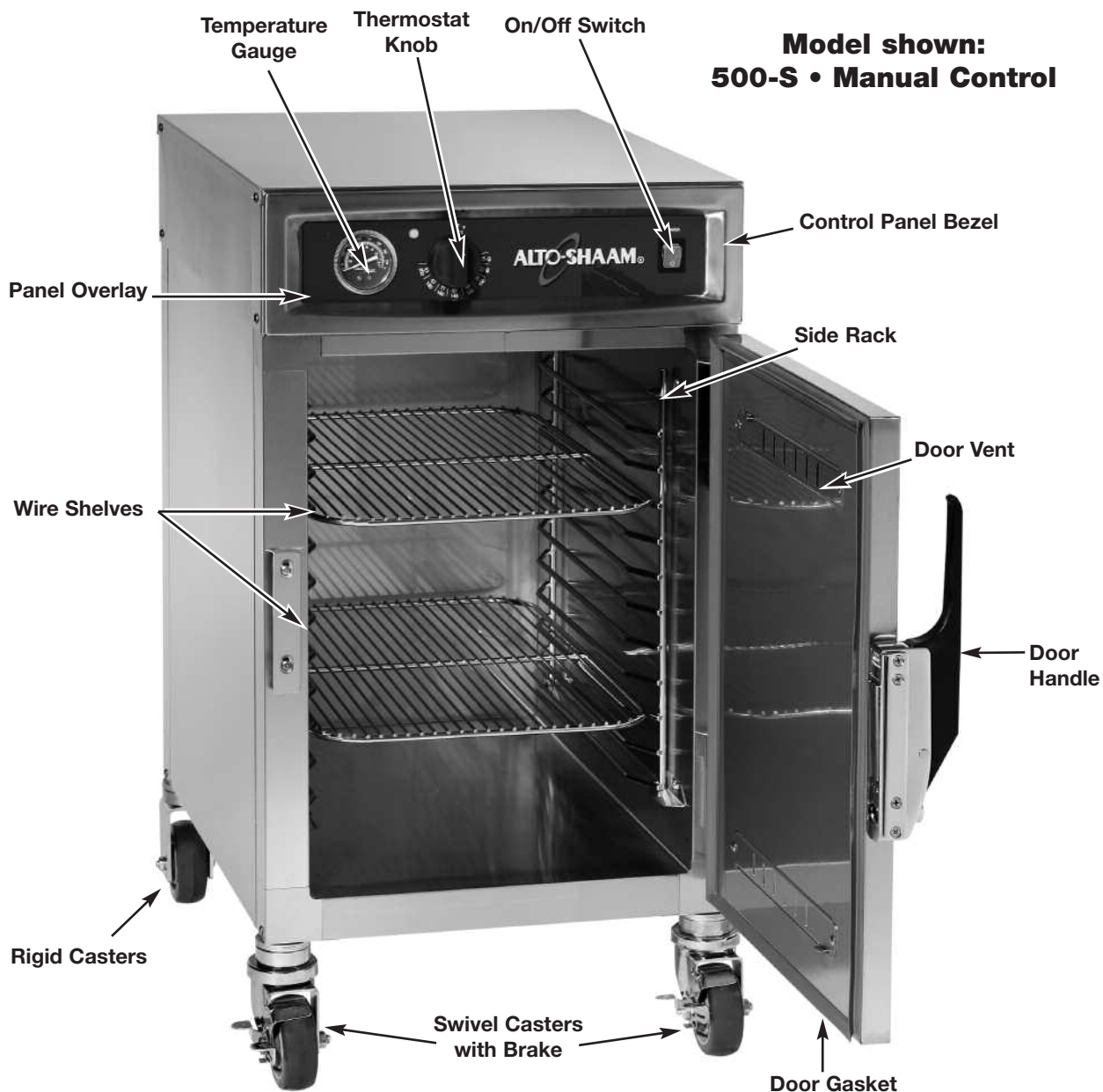

## MODEL 500-S, 750-S, 1000-S CABLE HEATING REPLACEMENT KIT No. 4874

includes:

CB-3044	Cable Heating Element . . . . .	108 feet
CR-3226	Ring Connector . . . . .	4
IN-3488	Insulation Corner . . . . .	1 foot
BU-3105	Shoulder Bushing . . . . .	4
BU-3106	Cup Bushing . . . . .	4
ST-2439	Stud . . . . .	4
NU-2215	Hex Nut . . . . .	8
SL-3063	Insulating Sleeve . . . . .	4
TA-3540	Electrical Tape . . . . .	1 roll

## MODEL 1200-S CABLE HEATING REPLACEMENT KIT No. 4878

includes:

CB-3045	Cable Heating Element . . . . .	.85 ft
CR-3226	Ring Connector . . . . .	4
IN-3488	Insulation Corner . . . . .	1 ft
BU-3105	Shoulder Bushing . . . . .	4
BU-3106	Cup Bushing . . . . .	4
ST-2439	Stud . . . . .	4
NU-2215	Hex Nut . . . . .	8
SL-3063	Insulating Sleeve . . . . .	4
TA-3540	Electrical Tape . . . . .	1 roll

# SERVICE

## MANUAL CONTROL - 500-S SERIES

Description	Part Numbers			
	500-S/HD	500-S/HD/PT	500-S/STD	500-S/STD/PT
Bottom	1005120	1005120	1005120	1005120
Casing Back, heavy duty	1007197	N/A	N/A	N/A
Casing Back, standard	N/A	N/A	1007198	N/A
Side, heavy duty	1003681	1003681	N/A	N/A
Side, standard	N/A	N/A	1007199	1007199
Bonnet	1005919	1005919	1005919	1005919
Panel Overlay, Manual control	PE-26877	PE-26877	PE-26877	PE-26877
Bezel, Control Panel	PE-26565	PE-26565	PE-26565	PE-26565
Cordset, 125V, 6'(1829mm)	CD-3232	CD-3232	CD-3232	CD-3232
Cordset, 208/240V, 9' (2743mm)	CD-3551	CD-3551	CD-3551	CD-3551
Cordset, 230V, 9' (2743mm)	CD-3922	CD-3922	CD-3922	CD-3922
Door Assembly, slab	15326	15326	15326	15326
Door Handle	HD-27080	HD-27080	HD-27080	HD-27080
Door Hinge	HG-2015	HG-2015	HG-2015	HG-2015
Door Gasket	GS-23790	GS-23790	GS-23790	GS-23790
Caster, stem, 3-1/2" (89mm) swivel w/brake	CS-25675	CS-25675	CS-25675	CS-25675
Caster, stem, 3-1/2" (89mm) rigid	CS-25674	CS-25674	CS-25674	CS-25674
Caster, stem, 5" (127mm) swivel w/brake	CS-24875	CS-24875	CS-24875	CS-24875
Caster, stem, 5" (127mm) rigid	CS-24874	CS-24874	CS-24874	CS-24874
Cable, Heating	CB-3044	CB-3044	CB-3044	CB-3044
Insulation	IN-2003	IN-2003	IN-2003	IN-2003
Block, Terminal	BK-3019	BK-3019	BK-3019	BK-3019
Light, Heat Indicator, 230V	LI-3951	LI-3951	LI-3951	LI-3951
Light, Heat Indicator, 120V	LI-3027	LI-3027	LI-3027	LI-3027
Switch, On/Off, Rocker, 125V	SW-34375	SW-34375	SW-34375	SW-34375
Switch, On/Off, Rocker, 230V	SW-34351	SW-34351	SW-34351	SW-34351
Temperature Gauge	GU-34198	GU-34198	GU-34198	GU-34198
Thermostat	TT-3057	TT-3057	TT-3057	TT-3057
Thermostat, 230V	TT-33626	TT-33626	TT-33626	TT-33626
Thermostat Knob	KN-26568	KN-26568	KN-26568	KN-26568



# SERVICE

## MANUAL CONTROL - 750-S SERIES

Description	Part Numbers			
	750-S/HD	750-S/HD/PT	750-S/STD	750-S/STD/PT
Bottom	1003679	1003679	1003679	1003679
Casing Back, heavy duty	1006710	N/A	N/A	N/A
Casing Back, standard	N/A	N/A	1006747	N/A
Side, heavy duty	1003682	N/A	N/A	N/A
Side, standard	N/A	N/A	1005959	1005959
Bonnet	1005919	1005919	1005919	1005919
Panel Overlay, Manual control	PE-26876	PE-26876	PE-26876	PE-26876
Bezel, Control Panel	PE-26566	PE-26566	PE-26566	PE-26566
Cordset, 125V, 6'(1829mm)	CD-3232	CD-3232	CD-3232	CD-3232
Cordset, 208/240V, 9' (2743mm)	CD-3551	CD-3551	CD-3551	CD-3551
Cordset, 230V, 9' (2743mm)	CD-3922	CD-3922	CD-3922	CD-3922
Door Assembly, slab	15324	15324	15324	15324
Door Handle	HD-27080	HD-27080	HD-27080	HD-27080
Door Hinge	HG-2015	HG-2015	HG-2015	HG-2015
Door Gasket	GS-22951	GS-22951	GS-22951	GS-22951
Caster, stem, 3-1/2" (89mm) swivel w/brake	CS-25675	CS-25675	CS-25675	CS-25675
Caster, stem, 3-1/2" (89mm) rigid	CS-25674	CS-25674	CS-25674	CS-25674
Caster, stem, 5" (127mm) swivel w/brake	CS-24875	CS-24875	CS-24875	CS-24875
Caster, stem, 5" (127mm) rigid	CS-24874	CS-24874	CS-24874	CS-24874
Cable, Heating	CB-3044	CB-3044	CB-3044	CB-3044
Insulation	IN-2003	IN-2003	IN-2003	IN-2003
Block, Terminal	BK-3019	BK-3019	BK-3019	BK-3019
Light, Heat Indicator	LI-3951	LI-3951	LI-3951	LI-3951
Light, Heat Indicator, 120V	LI-3027	LI-3027	LI-3027	LI-3027
Switch, On/Off, Rocker, 125V	SW-34375	SW-34375	SW-34375	SW-34375
Switch, On/Off, Rocker, 230V	SW-34351	SW-34351	SW-34351	SW-34351
Temperature Gauge	GU-34198	GU-34198	GU-34198	GU-34198
Thermostat	TT-3057	TT-3057	TT-3057	TT-3057
Thermostat, 230V	TT-33626	TT-33626	TT-33626	TT-33626
Thermostat Knob	KN-26568	KN-26568	KN-26568	KN-26568

# SERVICE

## MANUAL CONTROL - 1000-S SERIES

Description	Part Numbers			
	1000-S/HD	1000-S/HD/PT	1000-S/STD	1000-S/STD/PT
Bottom	1003680	1003680	1003680	1003680
Casing Back, heavy duty	1006710	N/A	N/A	N/A
Casing Back, standard	N/A	N/A	1004988	N/A
Side, heavy duty	1006951	1006951	N/A	N/A
Side, standard	N/A	N/A	1003468	1003468
Bonnet	1003801	1003801	1003801	1003801
Panel Overlay, Manual control	PE-26875	PE-26875	PE-26875	PE-26875
Bezel, Control Panel	PE-26567	PE-26567	PE-26567	PE-26567
Cordset, 125V, 6'(1829mm)	CD-3232	CD-3232	CD-3232	CD-3232
Cordset, 208/240V, 9' (2743mm)	CD-3551	CD-3551	CD-3551	CD-3551
Cordset, 230V, 9' (2743mm)	CD-3922	CD-3922	CD-3922	CD-3922
Door Assembly, slab	15147	15147	15147	15147
Door Handle	HD-27080	HD-27080	HD-27080	HD-27080
Door Hinge	HG-2535	HG-2535	HG-2535	HG-2535
Door Gasket	GS-23794	GS-23794	GS-23794	GS-23794
Caster, stem, 3-1/2" (89mm) swivel w/brake	CS-25675	CS-25675	CS-25675	CS-25675
Caster, stem, 3-1/2" (89mm) rigid	CS-25674	CS-25674	CS-25674	CS-25674
Caster, stem, 5" (127mm) swivel w/brake	CS-2026	CS-2026	CS-2026	CS-2026
Caster, stem, 5" (127mm) rigid	CS-2025	CS-2025	CS-2025	CS-2025
Cable, Heating	CB-3044	CB-3044	CB-3044	CB-3044
Insulation	IN-2003	IN-2003	IN-2003	IN-2003
Block, Terminal	BK-3019	BK-3019	BK-3019	BK-3019
Light, Heat Indicator, 250V	LI-3951	LI-3951	LI-3951	LI-3951
Light, Heat Indicator, 110V	LI-3027	LI-3027	LI-3027	LI-3027
Switch, On/Off, Rocker, 125V	SW-34375	SW-34375	SW-34375	SW-34375
Switch, On/Off, Rocker, 230V	SW-34351	SW-34351	SW-34351	SW-34351
Temperature Gauge	GU-34198	GU-34198	GU-34198	GU-34198
Thermostat	TT-3057	TT-3057	TT-3057	TT-3057
Thermostat, 230V	TT-33626	TT-33626	TT-33626	TT-33626
Thermostat Knob	KN-26568	KN-26568	KN-26568	KN-26568

# SERVICE

## MANUAL CONTROL - 1200-S SERIES

Description	Part Numbers			
	1200-S/HD	1200-S/HD/PT	1200-S/STD	1200-S/STD/PT
Bottom	1006332	1006332	1006332	1006332
Casing Back, heavy duty	1006704	N/A	N/A	N/A
Casing Back, standard	N/A	N/A	1006711	N/A
Side, heavy duty	1006428	1006428	1006428	1006428
Side, standard	1006422	1006422	1006422	1006422
Bonnet	1006387	1006387	1006387	1006387
Panel Overlay, Manual control	PE-26876	PE-26876	PE-26876	PE-26876
Bezel, Control Panel	PE-27268	PE-27268	PE-27268	PE-27268
Cordset, 125V, 6'(1829mm)	CD-3232	CD-3232	CD-3232	CD-3232
Cordset, 208/240V, 9' (2743mm)	CD-3551	CD-3551	CD-3551	CD-3551
Cordset, 230V, 9' (2743mm)	CD-3922	CD-3922	CD-3922	CD-3922
Door Assembly, slab	5005140	5005140	5005140	5005140
Door Handle	HD-27080	HD-27080	HD-27080	HD-27080
Door Hinge	HG-22338	HG-22338	HG-22338	HG-22338
Door Gasket	GS-23796	GS-23796	GS-23796	GS-23796
Caster, stem, 3-1/2" (89mm) swivel w/brake	CS-25675	CS-25675	CS-25675	CS-25675
Caster, stem, 3-1/2" (89mm) rigid	CS-25674	CS-25674	CS-25674	CS-25674
Caster, stem, 5" (127mm) swivel w/brake	CS-2026	CS-2026	CS-2026	CS-2026
Caster, stem, 5" (127mm) rigid	CS-2025	CS-2025	CS-2025	CS-2025
Cable, Heating	CB-3045	CB-3045	CB-3045	CB-3045
Insulation	IN-2003	IN-2003	IN-2003	IN-2003
Block, Terminal	BK-3019	BK-3019	BK-3019	BK-3019
Light, Heat Indicator, 250V	LI-3951	LI-3951	LI-3951	LI-3951
Light, Heat Indicator, 110V	LI-3027	LI-3027	LI-3027	LI-3027
Switch, On/Off, Rocker, 125V	SW-34375	SW-34375	SW-34375	SW-34375
Switch, On/Off, Rocker, 230V	SW-34351	SW-34351	SW-34351	SW-34351
Temperature Gauge	GU-34198	GU-34198	GU-34198	GU-34198
Thermostat	TT-3057	TT-3057	TT-3057	TT-3057
Thermostat, 230V	TT-33626	TT-33626	TT-33626	TT-33626
Thermostat Knob	KN-26568	KN-26568	KN-26568	KN-26568

# SERVICE

## MANUAL CONTROL

Front of unit

On/Off Switch  
SW-34375

Thermostat  
TT-3057  
TT-33626

Indicator Light  
LI-3951  
LI-3027

Temperature  
Gauge  
GU-34198

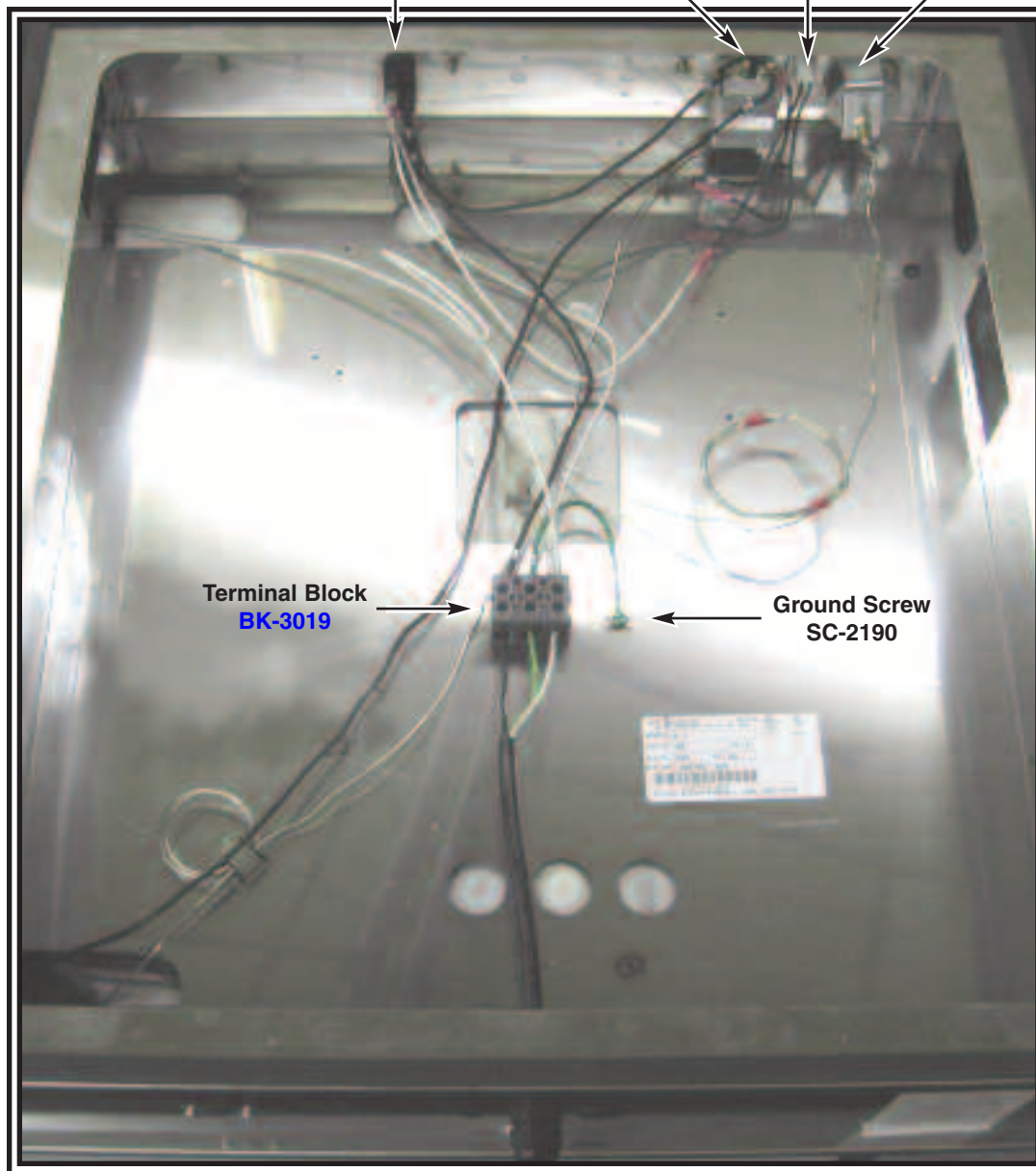

Terminal Block  
BK-3019

Ground Screw  
SC-2190

Back of unit



### DANGER

DISCONNECT UNIT FROM  
POWER SOURCE BEFORE  
CLEANING OR SERVICING.



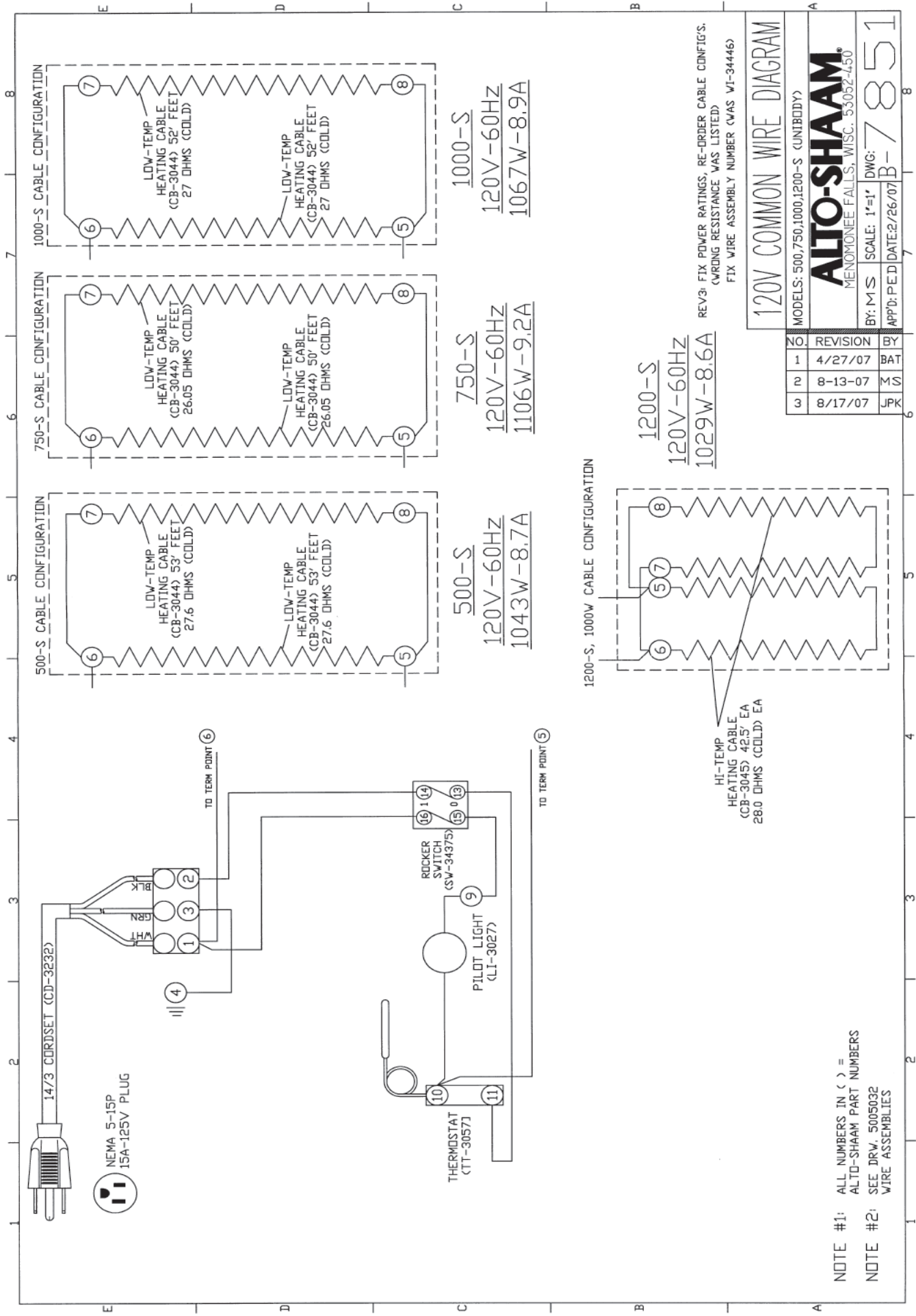

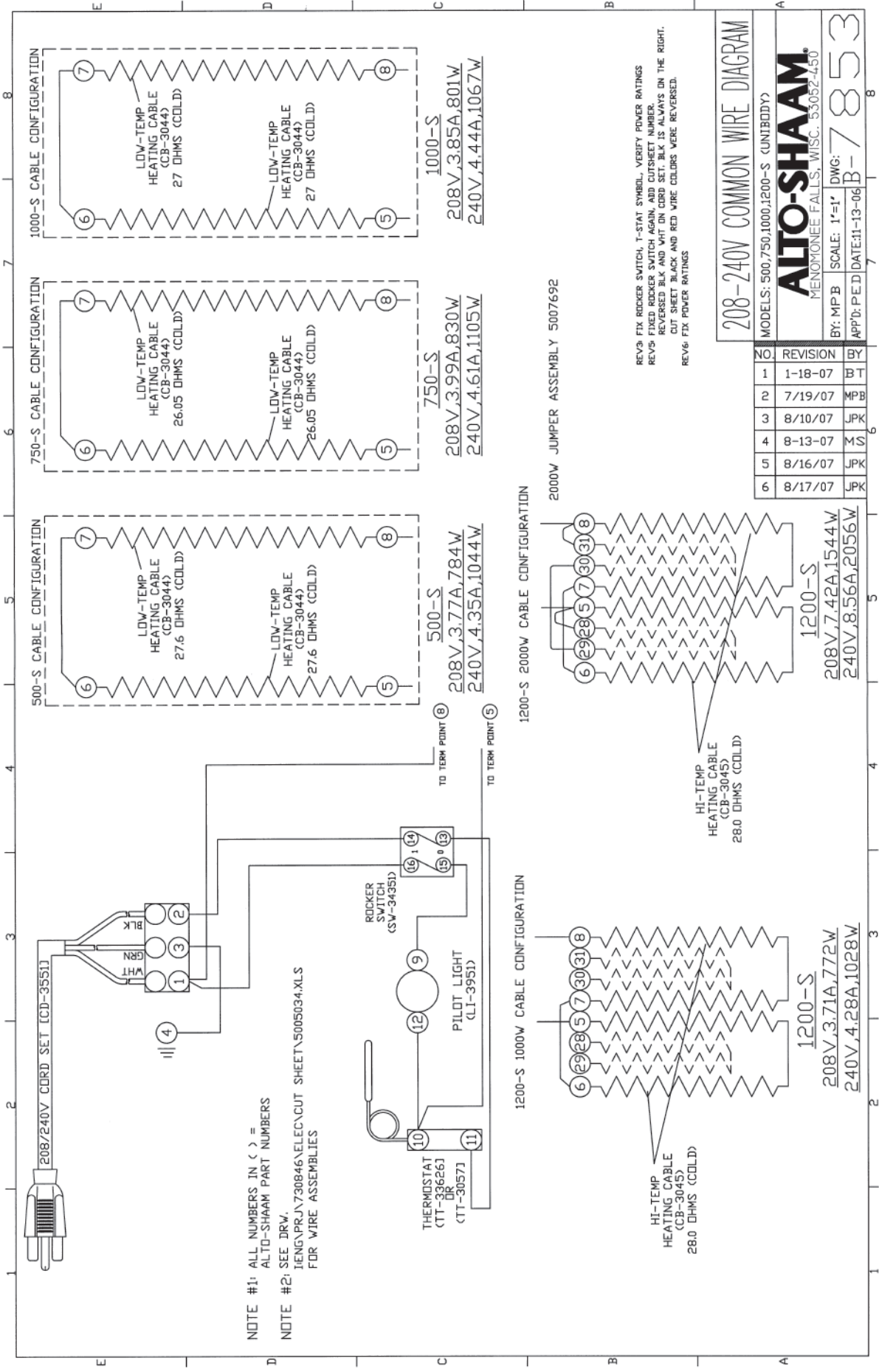

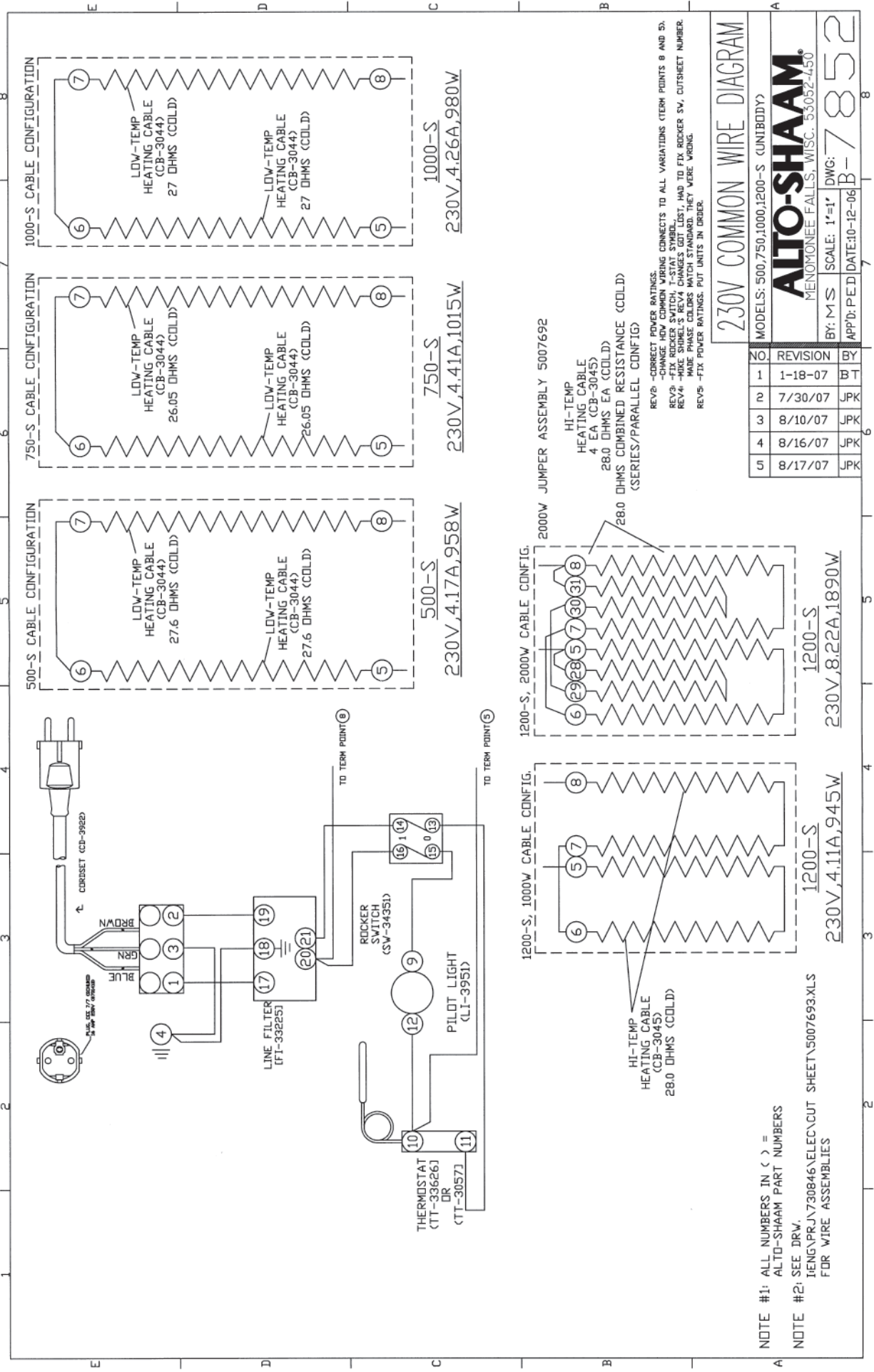

# TRANSPORTATION DAMAGE and CLAIMS



All Alto-Shaam equipment is sold F.O.B. shipping point, and when accepted by the carrier, such shipments become the property of the consignee.

Should damage occur in shipment, it is a matter between the carrier and the consignee. In such cases, the carrier is assumed to be responsible for the safe delivery of the merchandise, unless negligence can be established on the part of the shipper.

1. Make an immediate inspection while the equipment is still in the truck or immediately after it is moved to the receiving area. Do not wait until after the material is moved to a storage area.
2. Do not sign a delivery receipt or a freight bill until you have made a proper count and inspection of all merchandise received.
3. Note all damage to packages directly on the carrier's delivery receipt.
4. Make certain the driver signs this receipt. If he refuses to sign, make a notation of this refusal on the receipt.
5. If the driver refuses to allow inspection, write the following on the delivery receipt:  
*Driver refuses to allow inspection of containers for visible damage.*
6. Telephone the carrier's office immediately upon finding damage, and request an inspection. Mail a written confirmation of the time, date, and the person called.
7. Save any packages and packing material for further inspection by the carrier.
8. Promptly file a written claim with the carrier and attach copies of all supporting paperwork.

We will continue our policy of assisting our customers in collecting claims which have been properly filed and actively pursued. We cannot, however, file any damage claims for you, assume the responsibility of any claims, or accept deductions in payment for such claims.

# ALTO SHAAM. LIMITED WARRANTY

Alto-Shaam, Inc. warrants to the original purchaser that any original part that is found to be defective in material or workmanship will, at Alto-Shaam's option, subject to provisions hereinafter stated, be replaced with a new or rebuilt part.

The labor warranty remains in effect one (1) year from installation or fifteen (15) months from the shipping date, whichever occurs first. Alto-Shaam will bear normal labor charges performed during standard business hours, and excluding overtime, holiday rates or any additional fees.

The parts warranty remains in effect for one (1) year from installation or fifteen (15) months from the shipping date, whichever occurs first.

However, the heating element on Halo Heat® cook/hold ovens and the refrigeration compressor on Alto-Shaam Quickchillers™ are warranted for a period of five (5) years from installation. The labor warranty is the same as stated above; namely, for one (1) year from installation or fifteen (15) months from the shipping date, whichever occurs first.

### THIS WARRANTY DOES NOT APPLY TO:

1. Calibration.
2. Replacement of light bulbs and/or the replacement of display case glass due to damage of any kind.
3. Equipment damage caused by accident, shipping, improper installation or alteration.
4. Equipment used under conditions of abuse, misuse, carelessness or abnormal conditions including, but not limited to, equipment subjected to harsh or inappropriate chemicals including, but not limited to, compounds containing chloride or quaternary salts, poor water quality, or equipment with missing or altered serial numbers.
5. Damage incurred as a direct result of poor water quality, inadequate maintenance of steam generators and/or surfaces affected by water quality. Water quality and required maintenance of steam generating equipment is the responsibility of the owner/operator.
6. Damage caused by use of any cleaning agent other than Alto-Shaam's Combitherm® Cleaner including, but not limited to, damage due to chlorine or other harmful chemicals. Use of Alto-Shaam's Combitherm® Cleaner on Combitherm® ovens is highly recommended.
7. Any losses or damage resulting from malfunction, including loss of product or consequential or incidental damages of any kind.
8. Equipment modified in any manner from original model, substitution of parts other than factory authorized parts, removal of any parts including legs, or addition of any parts.

This warranty is exclusive and is in lieu of all other warranties, expressed or implied, including the implied warranties of merchantability and fitness for a particular purpose. In no event shall Alto-Shaam be liable for loss of use, loss of revenue or profit, or loss of product, or for any indirect or consequential damages. No person except an officer of Alto-Shaam, Inc. is authorized to modify this warranty or to incur on behalf of Alto-Shaam any other obligation or liability in connection with Alto-Shaam equipment.

ALTO-SHAAM, INC.

RECORD THE MODEL AND SERIAL NUMBER OF THE APPLIANCE FOR EASY REFERENCE.  
ALWAYS REFER TO BOTH MODEL AND SERIAL NUMBER IN ANY CONTACT WITH ALTO-SHAAM REGARDING THIS APPLIANCE.

Model: \_\_\_\_\_ Date Installed: \_\_\_\_\_  
Voltage: \_\_\_\_\_ Purchased From: \_\_\_\_\_  
Serial Number: \_\_\_\_\_

W164 N9221 Water Street • P.O. Box 450 • Menomonee Falls, Wisconsin 53052-0450 • U.S.A.  
PHONE: 262.251.3800 • 800.558-8744 USA/CANADA FAX: 262.251.7067 • 800.329.8744 U.S.A. ONLY  
WEBSITE: www.alto-shaam.com

PRINTED IN U.S.A.