

OPERATING INSTRUCTIONS

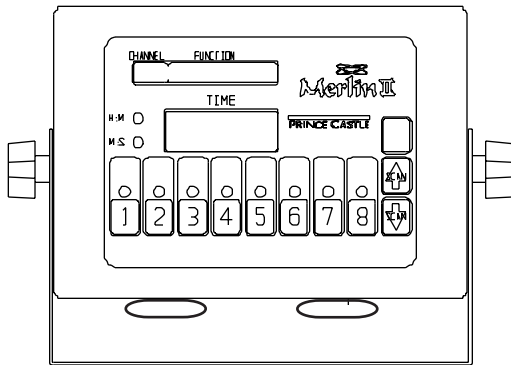

Merlin II

Multi-Function Computers Model No. 840-C, 840-CJ & 840-CF Series



Pictured Model 840-C8

ELECTRICAL

840-C Series

120 Volts
50/60 Hz
30 Watts
Single Phase

840-CF Series

220 Volts
50/60 Hz

840-CJ Series

200 Volts
50/60 Hz

TABLE OF CONTENTS

PAGE

Installation	2
Programming	2-7
Operation	7-8
Cleaning	8
Parts List	8
Exploded View	9
Troubleshooting	9
Wiring Diagrams	10

LIMITED WARRANTY

This product is warranted to be free from defects in material and/or workmanship for a period of 1 year from date of original installation, not to exceed 18 months from the date of manufacture.

Any component which proves to be faulty in material and/or workmanship will be replaced or repaired (at the option of Prince Castle, Inc.) without cost to the customer for parts and labor. This equipment is portable; charges for on-location service (e.g., trip charges, mileage) are not included in the provisions of this warranty.

This warranty is subject to the following exceptions/conditions:

- Use of any non-genuine Prince Castle parts voids this warranty.
- All labor to be performed during regular work hours. Overtime premium (the incremental amount) will be charged to the customer.
- Damage caused by carelessness, neglect and/or abuse (e.g., dropping, tampering or altering parts, equipment damaged in shipment, by fire, flood or an act of God) is not covered under this warranty.
- All problems due to operation at voltages other than that specified on equipment nameplates are not covered by this warranty. Conversion to correct voltage is the customer's responsibility.
- This equipment must be serviced by Prince Castle Authorized Service Agency or a Prince Castle Service Technician during the warranty period.

Table Of Contents

I	Introduction
II	Installation
III	Control Panel
IV	Programming
	A. Channel Programming.
	B. Program Specials.
	C. Probe "A".
	D. Probe "B".
V	Recovery Time Check
VI	Operation
VII	Cleaning
VIII	Parts List Exploded View
IX	Troubleshooting
X	Wiring Diagram

I INTRODUCTION

The 840 Series Compensating Timers allow the user great flexibility in programming options. Each channel can be programmed to include a total cook time, three duty functions during that cook time, a hold time and a hold duty function. Each channel can be programmed to use either Probe "A" or "B" for compensated time or no probe at all for straight countdown time.

II INSTALLATION

1. After you have removed the timer from the carton, inspect the unit for signs of damage. If there is damage to the unit:
 - Notify carrier within 24 hours after delivery.
 - Save carton and packing materials for inspection purposes.
 - Contact your Prince Castle Dealer for replacement or the Prince Castle Customer Sales Department at 1-800-722-7853 if purchased directly.
2. Verify that all parts have been received. Mounting bracket and hardware are provided.
3. To mount the timer, place mounting brackets in desired location. Scribe location of mounting holes, center punch, and drill holes. Attach timer to mounting brackets placing star washer between bracket and timer.

III CONTROL PANEL

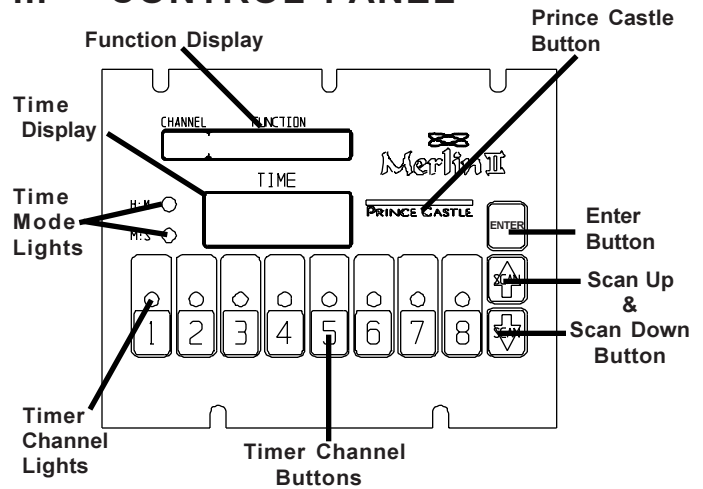

IV PROGRAMMING

There are four different programming features within the program mode:

- A) **Program Timers** is used to program the Cook, Hold and Duty times for each channel.
 - B) **Prog Probe A** is used to program the set point temperature or calibrate the left probe.
 - C) **Prog Probe B** is used to program the set point temperature or calibrate the right probe.
 - D) **Program Specials** is used to select the appropriate temperature scale (F or C), select which probes will be used for each timer channel or to test the fryer recovery time.
1. Press and hold the **PRINCE CASTLE LOGO** for eight seconds, a short beep will sound and **LOGO=QUIT** will appear in the display.

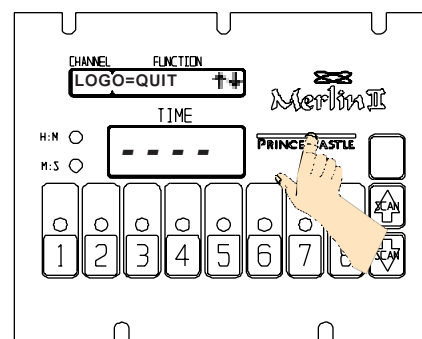

Press either the **SCAN UP BUTTON** or the **SCAN DOWN BUTTON** to switch through the four programming options until you get to the appropriate option.

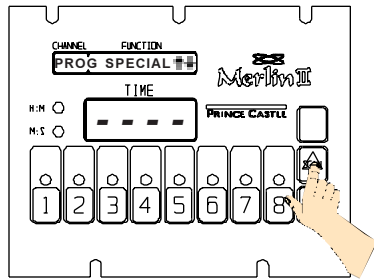

Press the **ENTER BUTTON** to enter that programming mode.

A. Prog. Timers

1. After pressing the **ENTER BUTTON**, **SEL CH/ LOGO=QUIT** will appear in the display.

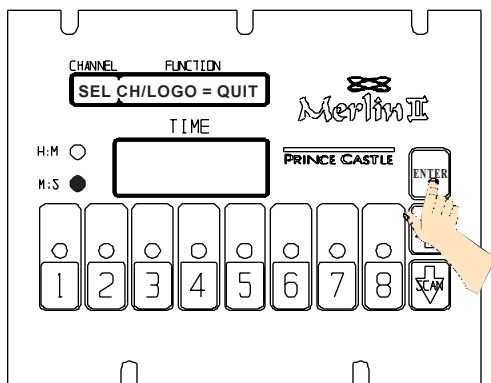

2. Press the **TIMER CHANNEL BUTTON** to be programmed. The **TIMER CHANNEL LIGHT** will turn Amber and a beep will sound. The **FUNCTION** display will read, **CKT=COOK TIME**. The current complete cook time for that channel will be displayed in the **TIME** display, and the **TIME MODE LIGHTS** will indicate either **H:M** OR **M:S**.

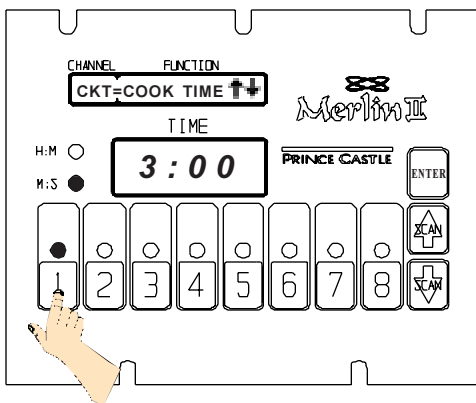

3. At this point you can program in your complete cook time by using the **SCAN/UP BUTTON** or the **SCAN/DOWN BUTTON**. Once you have reached your desired time press the **ENTER** button to store your complete cook time.

IMPORTANT: To change from minutes and seconds **M:S** to hours and minutes **H:M**, press and hold the **SCAN/UP BUTTON**. When the display

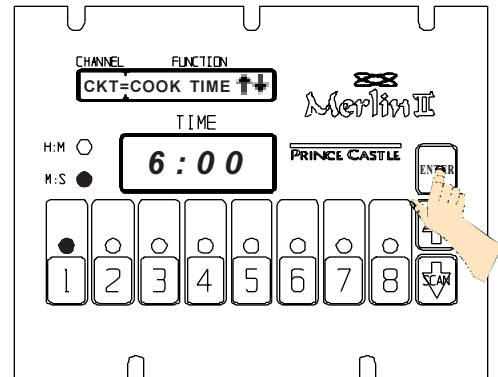

reaches 59:59 it will automatically change to 1:00 Hour and the **TIME MODE LIGHT** will switch from **M:S** to **H:M**. The program value for the **H:M** indicator is from 1:00 hour to 60 hours: 00 minutes.

4. Once you press **ENTER**, **CKC=MAN CANCEL** or **CKC=AUT CANCEL** will appear in the **FUNCTION DISPLAY**, press the **SCAN UP BUTTON** or **SCAN DOWN BUTTON** to switch from one mode to the other. Press the **ENTER** button to store your selection or if no change is required.

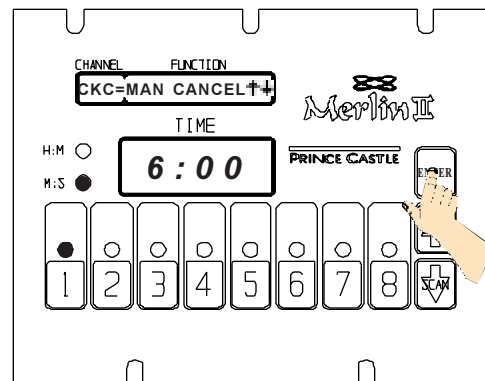

- After you press the **ENTER BUTTON**, the **FUNCTION** display will change to **CKL=REMOVE**. An alternate function name can be selected (see list below) by using the **SCAN UP** or **SCAN DOWN** arrows. Press the **ENTER BUTTON** to store the selection. The function name selected will be displayed during the final countdown sequence.

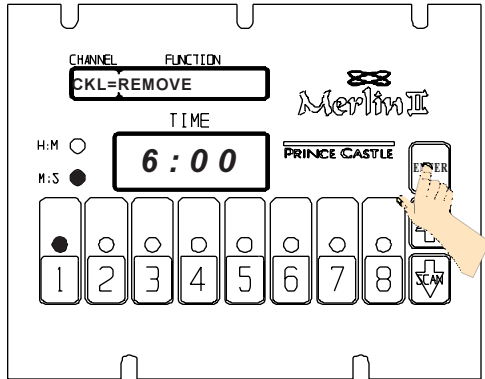

Note: The function name options are as follows:

BAKE, BAKE MORE, BASTE, BRAISE, CHILL, COOK, COOK DUTY 1, COOK DUTY 2, COOK DUTY 3, COOK MORE, COVER, DISCARD, DONE, DROP, END, FOLD, FRY, FRY MORE, GRILL, GRILL MORE, HOLD, HOLD DUTY, MIX, POACH, POUR, REMOVE, ROTATE, SEAR, SHAKE, SIDE 1, SIDE 2, STIR, TURN, WHIP And WRAP.

- If no other programming changes are required for this channel, press the **TIMER CHANNEL BUTTON** until **SEL CH/LOGO=QUIT** appears in the **FUNCTION DISPLAY**. Another **TIMER CHANNEL BUTTON** can then be selected for program changes or the **PRINCE CASTLE LOGO BUTTON** can be pressed to exit the **PROGRAM TIMERS** mode. To change the **DUTY** function press the **TIMER CHANNEL BUTTON** once.
- The function display will read **D1T=DUTY1 TIME** and the **TIME DISPLAY** will show the current Duty Time.

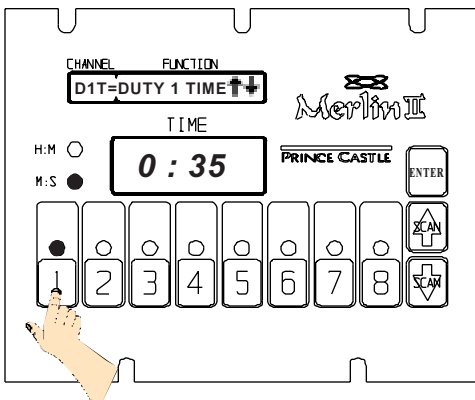

- Press the **SCAN UP** or **SCAN DOWN ARROWS** to adjust the time setting. (**Note:** If no duty time is desired set the time to 00:00). Press the **ENTER BUTTON** to store the new **DUTY 1** time.
- Once you press **ENTER**, **CKC=MAN CANCEL** or **CKC=AUT CANCEL** will appear in the **FUNCTION DISPLAY**, press the **SCAN UP BUTTON** or **SCAN DOWN BUTTON** to switch from one mode to the other. Press the **ENTER** button to store your selection or if no change is required.

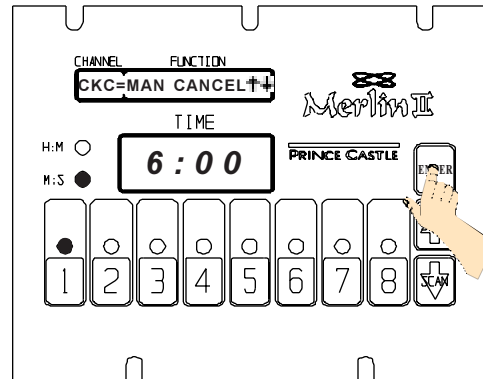

- After you press the **ENTER BUTTON**, the current **DUTY FUNCTION** title will now appear in the **FUNCTION DISPLAY**. Press the **SCAN UP** or **SCAN DOWN** button to rename the **DUTY FUNCTION**; the available list of **DUTY FUNCTION** names is listed below. Press the **ENTER BUTTON** to store the selection.

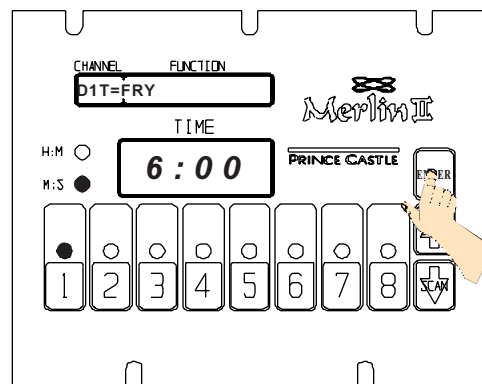

Note: The function name options are as follows:

BAKE, BAKE MORE, BASTE, BRAISE, CHILL, COOK, COOK DUTY 1, COOK DUTY 2, COOK DUTY 3, COOK MORE, COVER, DISCARD, DONE, DROP, END, FOLD, FRY, FRY MORE, GRILL, GRILL MORE, HOLD, HOLD DUTY, MIX, POACH, POUR, REMOVE, ROTATE, SEAR, SHAKE, SIDE 1, SIDE 2, STIR, TURN, WHIP And WRAP.

- Follow steps 6-11 to program changes to the other **DUTY FUNCTIONS** and the **HOLD FUNCTIONS**.
- When all the **TIMER CHANNEL BUTTONS** have been programmed, and **SEL CH/LOGO=QUIT** appears in the **FUNCTION DISPLAY**,

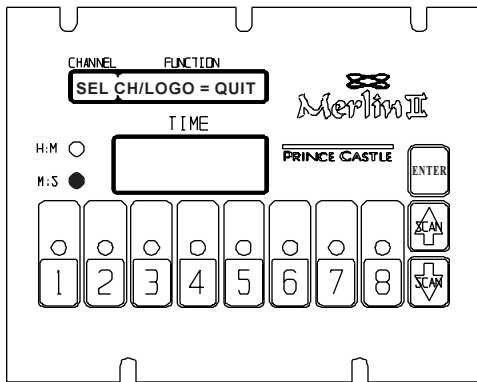

press the **PRINCE CASTLE LOGO BUTTON** to return to the main programming menu, indicated by **LOGO=QUIT** appearing in the **FUNCTION DISPLAY**.

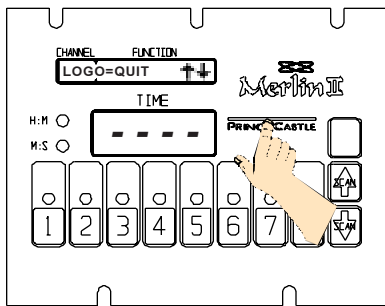

B) Program Specials

- When **LOGO=QUIT** appears in the **FUNCTION DISPLAY**, press either the **SCAN UP** or **SCAN DOWN** **BUTTON** until **PROG SPECIALS** appears in the **FUNCTION DISPLAY**.

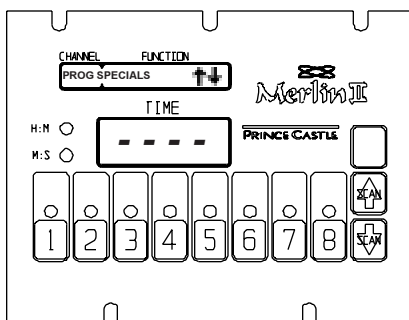

- Press **ENTER BUTTON** twice until **TEMP=F** or **TEMP=C** appears in the display.

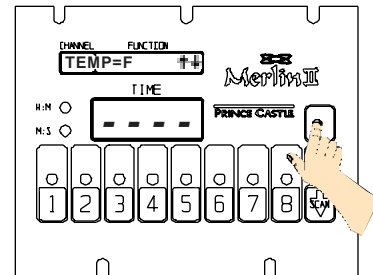

- Press either the **SCAN UP** or **SCAN DOWN** **BUTTON** to switch from one temperature scale to the other. Press the **ENTER** **BUTTON** to store the chosen temperature scale
- All of the channel **LED's** will be lit and **SEL CHAN=PROBE** will be in the display. A **GREEN LED** designates **PROBE "A"** (The Left Probe) will be used in conjunction with the selected **TIMER CHANNEL** **BUTTON**, A **RED LED** designates **PROBE "B"** (The Right Probe) will be used, **NO LED** means a Timer Channel is set up for straight countdown timing without the use of either probe.

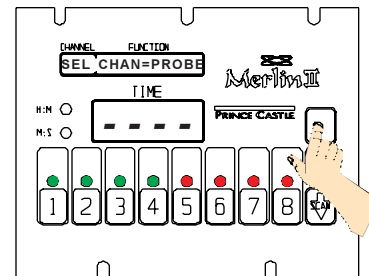

- Pressing the **CHANNEL TIMER** **BUTTON** will change the probe option from **Green (Probe A)** to **Red (Probe B)** to no light (**No Probe**) for that particular Timer Channel.

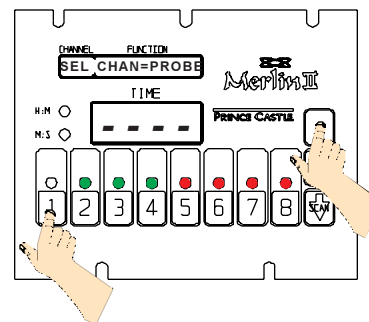

- When the appropriate probe has been selected for Timer Channel, press the **ENTER** **BUTTON** three times until **ENTER/LOGO=QUIT** appears in the **FUNCTION DISPLAY**.

- Press the **PRINCE CASTLE LOGO BUTTON** one time and **LOGO=QUIT** will appear in the **FUNCTION DISPLAY**.

C) Probe "A" Programming

- When **LOGO=QUIT** appears in the **FUNCTION DISPLAY** press either the **SCAN UP** or **SCAN DOWN BUTTON** until **PROG PROBE A** appears in the **FUNCTION DISPLAY**.

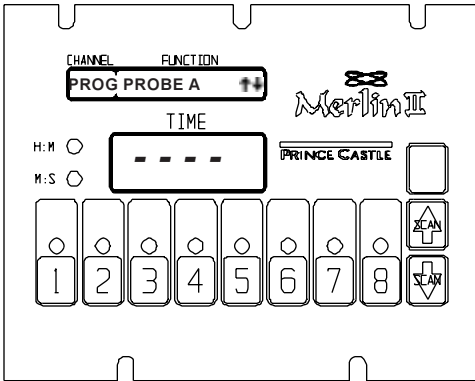

- Press the **ENTER BUTTON** twice and the **FUNCTION DISPLAY** will read **PrA-COOK TEMP** and the **TIME DISPLAY** will show your current cook temperature.

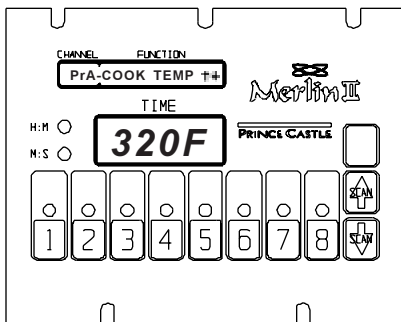

- Press either the **SCAN UP** or **SCAN DOWN BUTTON** to adjust the set point temperature. **Note:** The set point temperature should be the same as the temperature set on the fryer.

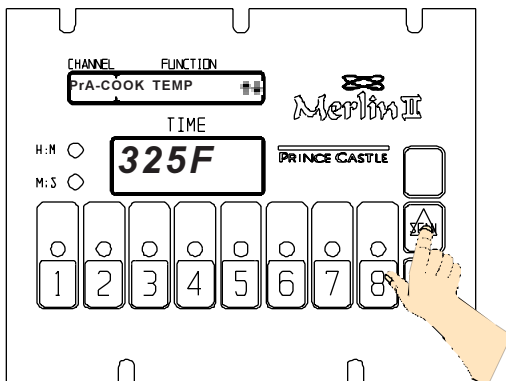

- Press the **ENTER BUTTON** to store the new temperature, **PrA-CAL (00)** will appear in the **FUNCTION DISPLAY** and the probe temperature in the **TIME DISPLAY**.

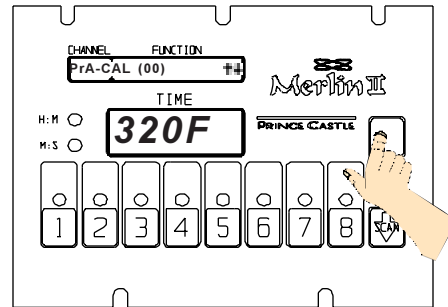

- Use a thermometer to measure the actual fryer temperature.
- Press either the **SCAN UP** or **SCAN DOWN BUTTON** to change the offset value so that the temperature in the **TIME DISPLAY** equals the actual fryer temperature.

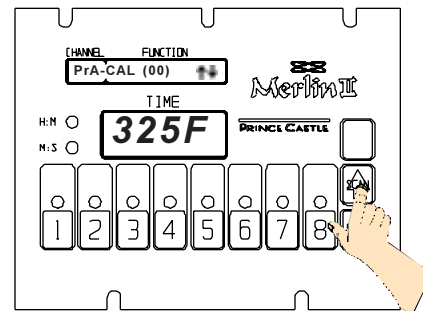

- Press the **ENTER BUTTON** to store the changes.
- Press the **PRINCE CASTLE LOGO BUTTON** to return to the main programming menu. Press the **SCAN UP** or **SCAN DOWN BUTTON** until **Prog Probe B** appears in the **FUNCTION DISPLAY**.

D) Probe "B" Programming

Follow the steps in **SECTION C** for programming this probe.

- Follow Steps 1-7 For Probe B
- Press the **ENTER BUTTON** to store changes **ENTER LOGO=QUIT** will appear in the **FUNCTION DISPLAY**.
- Press the **PRINCE CASTLE LOGO BUTTON** twice to return to the **RUN MODE**.

V RECOVERY TIME CHECK

The purpose of the RECOVERY TIME CHECK is to determine the length of time needed for the shortening in the fryer to rise from 275° F (135° C) to 325° F (162° C). The RECOVERY TIME CHECK should either be done at the same time as calibrating the fryer temperature or when new shortening is put into the fryer. Note: It is important that the shortening temperature is less than 275°F (135°C) when the RECOVERY TIME CHECK is started.

1. Press and hold the **PRINCE CASTLE LOGO** for eight seconds, a short beep will sound and **LOGO=QUIT** will appear in the **FUNCTION DISPLAY**.

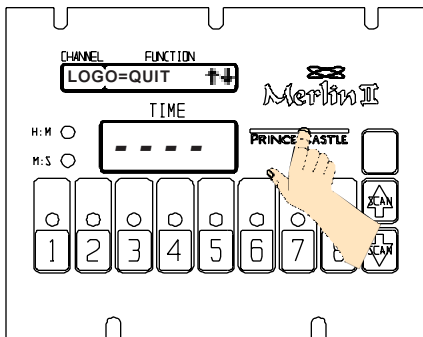

2. Press the **SCAN UP BUTTON** once and **PROG SPECIAL** will appear in the **FUNCTION DISPLAY**.

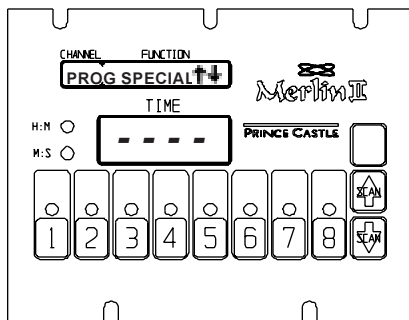

3. Press the **ENTER BUTTON** four times **PrA-RECOVERY** will appear in the **FUNCTION DISPLAY**.

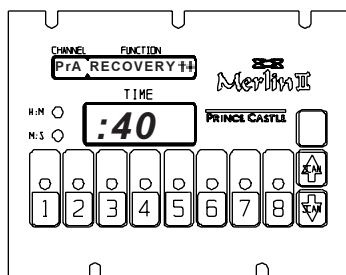

4. Press either the **SCAN UP** or **SCAN DOWN BUTTON** to begin the **RECOVERY TIME CHECK**. **PrA<275F-WAIT** or **(PrA<135C-WAIT)** will appear in the **FUNCTION DISPLAY** and **00** in the **TIME DISPLAY** until the shortening reaches **275° F (135°C)**.

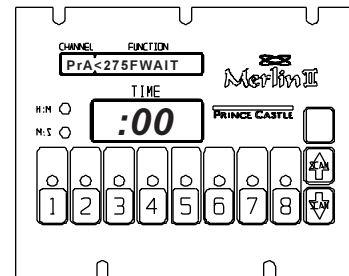

5. When the temperature reaches **275° F (135°C)**, the **FUNCTION DISPLAY** will show the shortening temperature (**PrA 300F-WAIT**, for example) and the seconds will start counting up in the **TIME DISPLAY**, 01, 02, 03 for example.
6. When the temperature reaches **325° F (162°C)** the **FUNCTION DISPLAY** will read **PrA>325F-DONE (PrA>162C-DONE)** and the **TIME DISPLAY** will stop counting up. This is your Recovery Time.

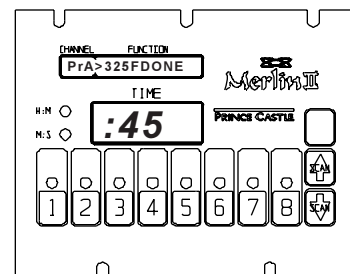

5. Press the **ENTER BUTTON** to store the recovery time, the **FUNCTION DISPLAY** will now read **PrB RECOVERY**. Follow steps 1-6 to check the recovery time on **PROBE "B"**.

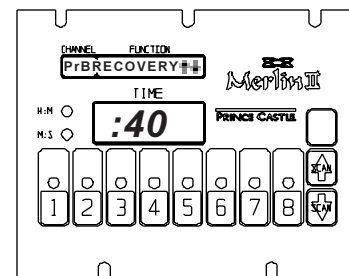

6. After saving the **PROBE "B"** recovery time the **FUNCTION DISPLAY** will read **ENTER/ LOGO=QUIT**. Press the **PRINCE CASTLE LOGO BUTTON** twice to go back to the **RUN MODE**

VI OPERATION

1. Press a channel button to activate a timing cycle. (All channels can be activated and running at the same time.) The channel with the least amount of function time remaining will be displayed in the **FUNCTION DISPLAY** along with its next function. The time remaining will countdown in the **TIME DISPLAY**, and the time value **M:S** or **H:M** will be illuminated.

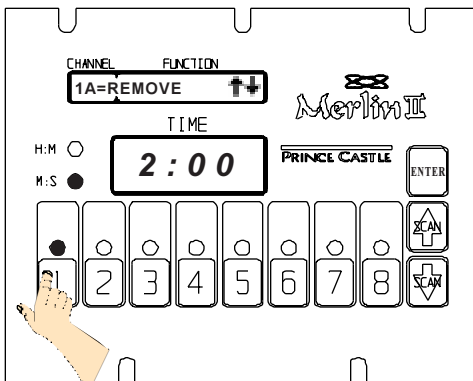

2. Press the desired channel button three times within five seconds to cancel an active timing cycle.

IMPORTANT: The channel timer button's multi-colored LED indicator shows the status of the timer. The indicator has three colors: green, yellow, and red. The LED will be green during the first 70% of the countdown. It changes to yellow during the next 20% of the countdown. It will be red during the final 10% of the countdown, and will start flashing red once the time has run out.

Note: If a Manual Cancel is programmed into a duty function the LED will flash red until the channel button has been pressed. If an Automatic Cancel is programmed the LED will flash green for 5 seconds and the alarm will automatically turn off.

3. The timer will countdown from the programmed value to zero. When the complete cooked time is finished, the TIME DISPLAY flashes **00** and the alarm sounds.
4. When the timing cycle is complete, and the alarm sounds, press the channel button with the flashing red indicator to cancel the alarm.

5. The scan feature is used to check the time values on other active channels. There are two different ways to scan active channels. Press the **SCAN/UP** or **SCAN/DOWN** button. Or press any of the active **TIMER CHANNEL** buttons. If no other button is pressed within 5 seconds, the display will change to show the timer with the least amount of time left.
6. You can change the sound level of the alarm in **RUN MODE**. Press and hold the **PRINCE CASTLE LOGO**; then, within six seconds, press either the **SCAN UP BUTTON** or the **SCAN DOWN BUTTON**. The **SCAN UP BUTTON** adjusts the sound level to the louder alarm, and the **SCAN DOWN BUTTON** adjusts the sound level to the lower alarm.

VII CLEANING

1. Do not allow grease to build up on the timer, wipe it down daily with clean damp cloth.

IMPORTANT: Do not use abrasive or chemical cleaners on your timer, this may cause damage to the overlay.

VIII PART LIST

<u>ITEM</u>	<u>PART NUMBER</u>	<u>DESCRIPTION</u>
1	69-079S	Rivet Plastic Push Pin
2	840-100	Rear Cover
3	840-134S 840-109S	Main P.C.Board Auxillary P.C.Board (840-C8D & 840-C16D)
4	71-042-02S	Display Board
5	88-653-2-7S	Speaker Assy.
6	840-096S 840-110S	Switch Panel Assy. (840-C8 Series) Switch Panel Assy. (840-C4 Series)
7	70-048S	Knob W/Washer (Pkg of 2)
8	840-103 840-115	Chassis (840-C4 & C8) Chassis (840-C8D & C16D)
9	72-292S 72-293-01JS 72-293-04FS	Power Supply (110V) Power Supply (100V) Power Supply (220-240V)
*10	840-140 840-141	Left Probe Connector Right Probe Connector
*	Not Shown	

VIII EXPLODED VIEW

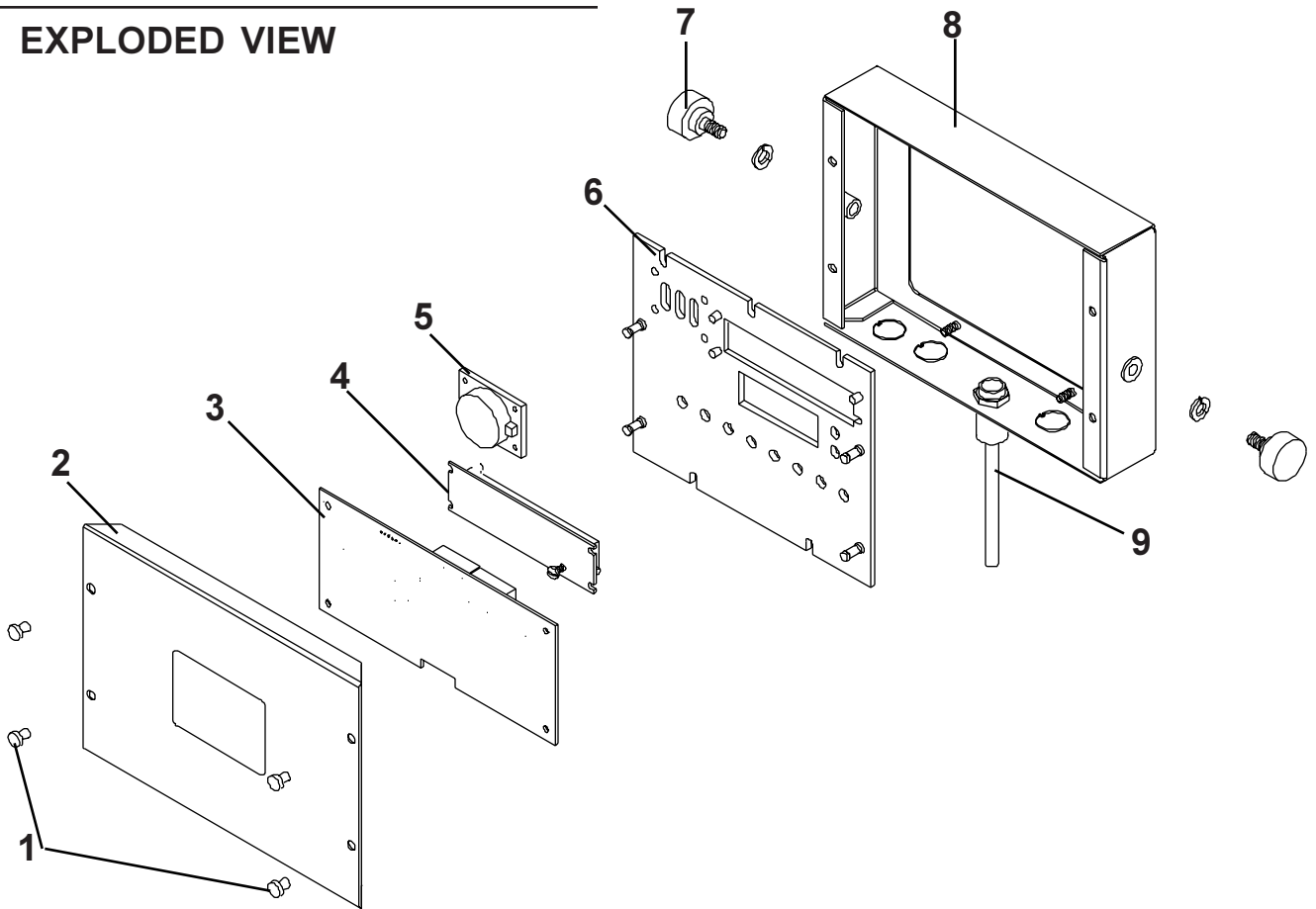

XI TROUBLESHOOTING

PROBLEM	CAUSE	SOLUTION
A. No displays or indicators lit.	Unit unplugged. Store's circuit breaker blown. Defective transformer. Circuit inoperable.	Plug unit in. Reset breaker. Replace Main Circuit Board. Replace Main Circuit Board.
B. Absence of Audio Alarm.	Speaker inoperable. Circuit inoperable.	Replace Speaker. Replace Main Circuit Board.
C. Unit will not enter program mode.	All channels are still counting. Logo Switch inoperable.	Wait until channels are in stop mode. Replace Switch Panel.
D. Unit enters program mode. but cannot change times.	The channel is still counting. Arrow Switch inoperable. Circuit Inoperable	Wait until channel is in stop mode. Replace Switch Panel. Replace Main Circuit Board.
E. Unable to start, stop, or store timer presets in program mode. Missing or abnormal characters in displays.	Circuit inoperable.	Replace Switch Panel. If problem persists, replace Main Circuit Board.

X WIRING DIAGRAM

