

Operation Manual

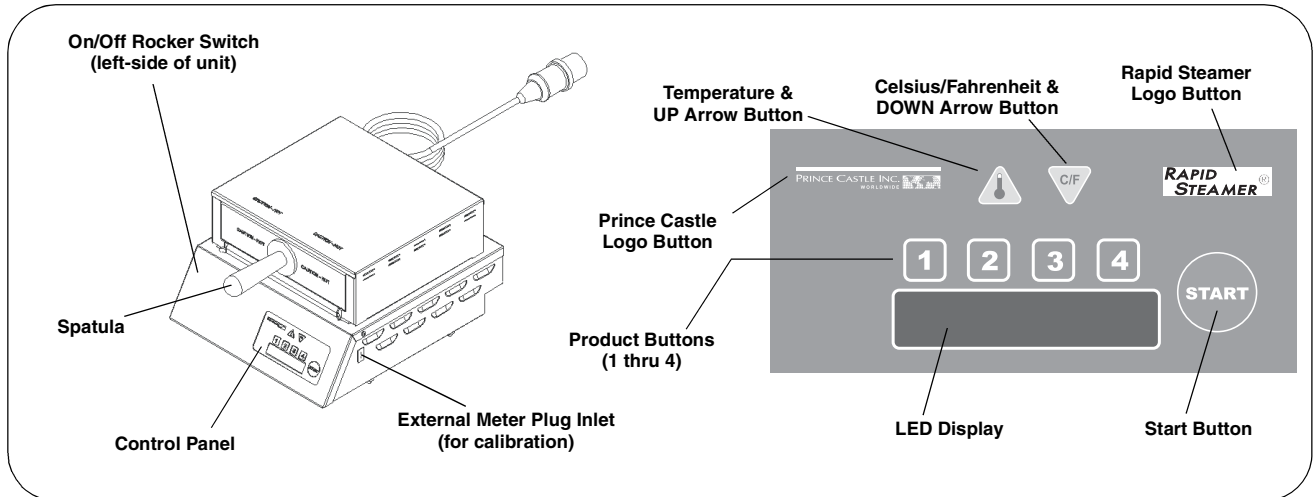

Steamer
625-MCD & MFY

Product Identification



LIMITED WARRANTY

This product is warranted to be free from defects in material and/or workmanship for a period of (2) two years from the date of original installation, not to exceed 30 months from date of shipment from our factory. Any component which proves to be faulty in material and/or workmanship will be replaced or repaired (at the option of Prince Castle, LLC) without cost to the customer for parts or labor. This warranty covers on location service (i.e. trip charges and/or mileage). Travel mileage is limited to 100 miles (200 kilometers) round-trip (one-trip warranty) from an authorized service agency or its sub-service agency.

This warranty is subject to the following exceptions/conditions:

- The warranty does not cover the water tube – part no. 625-357S in addition to any consumable items such as gaskets, o-rings and light bulbs.
- The warranty does not cover water containment problems such as foreign material in water lines or inside the solenoid valves due to inconsistencies in water quality.
- Water pressure problems or failures resulting from improper/incorrect voltage supply are not covered under the limited warranty.
- The use of any non-genuine Prince Castle parts voids the warranty.
- The warranty does not include overtime charges or work done by unauthorized service agencies or personnel.
- Damage caused by carelessness, neglect, and/or abuse (e.g. dropping, tampering or altering parts, equipment damaged in shipment, by fire, flood or an act of God) is not covered under this warranty.

TABLE OF CONTENTS

Product Identification	1
Safety Information	2
General	2
Installation	2
Operation	2
Temperature Calibration	3
View Firmware Version	3
Manual Reset	3
Programming Product Name and Water Cycle	4
Error Messages	5
Cleaning - Daily	6
Cleaning - Monthly	7
Exploded View and Parts List	8
Wiring Diagram	10



PRINCE CASTLE LLC
WORLDWIDE

A Marmon Group/Berkshire Hathaway Company

355 East Kehoe Blvd. • Carol Stream, IL 60188 USA
Telephone: 630-462-8800 • Toll Free: 1-800-PCASTLE
Fax: 630-462-1460 • www.princecastle.com

Safety Information

⚠ WARNING

Indicates information important to the proper operation of the unit. Failure to observe may result in damage to the equipment and/or severe bodily injury or death.

⚠ CAUTION

Indicates information important to the operation of the unit. Failure to observe may result in damage to the equipment.

Important

Prince Castle reserves the right to change specifications and product design without notice. Such revisions do not entitle the buyer to corresponding changes, improvements, additions or replacements for previously purchased equipment.

Installation

Remove the unit from the carton and inspect for signs of damage. If there is damage to the unit:

- notify the carrier within 24 hours of delivery
- save carton and packaging materials for inspection purposes
- contact your local dealer, or if purchased directly, the Prince Castle Sales Department at 800-722-7853 or 1-630-462-8800 to arrange for a replacement unit.

WATER CONNECTION REQUIREMENTS

If this is a new installation, accessory - 625-104S or 625-330S Regulator Assembly Kit is required for the 625-MCD. The 625-MFY comes with the 625-253S Regulator Assembly. Always use area codes for determination.

NOTE: When installing this unit, the ambient temperature at the mounting site should not exceed 37.8°C (100°F).

⚠ CAUTION

All electrical connections must be in accordance with local electrical codes and any other applicable codes.

Plug the unit into an applicable electrical receptacle. Connect the water line to the back of the unit.

⚠ CAUTION

Water connection must provide maximum water pressure of 20 – 30 psi (138 – 207 kPa).

This equipment is to be installed with adequate backflow protection to comply with applicable Federal, State and Local codes.

Operation

- 1** A. Turn unit power On/Off switch to ON position. The display flashes all segments for 3 seconds. Then display will show *PRINCE CASTLE* for seven seconds.
- B. After ten seconds the display will show *PRE-HEAT*.
- NOTE: The next-to-left most decimal point appears indicating power is applied to the platen. Platen will heat to the setpoint temperature.*

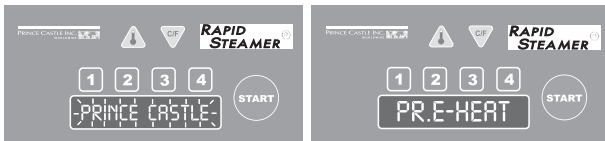

- 2** A. When the unit reaches the setpoint temperature, display will show the product name assigned to button 1.
- B. If 1 is the desired product to be steamed, pull out the spatula and place the product onto the spatula, cut side down. Or press product buttons 2, 3 or 4, then place product on the spatula, cut side down.

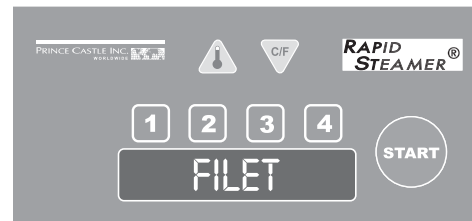

- 3** Place the spatula fully into the unit and press the START button. A beep will sound and the display will start to count down the steam cycle. (The countdown will round down to the nearest second, e.g. 11.5 seconds will appear as 11 seconds in the display.)



- 4** When steam cycle is complete, the unit will sound a tone and the display will flash *REMOVE*. Pull out the spatula and remove the finished product.

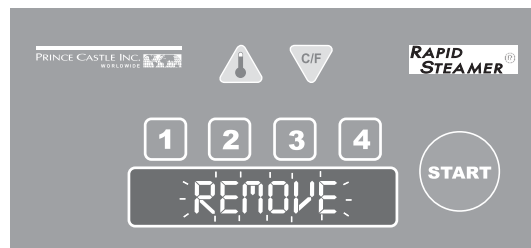

Temperature Calibration

- 1 A. Press and hold the TEMPERATURE button. The display will show the current temperature setting for Celsius (C) or Fahrenheit (F).
B. While holding the TEMPERATURE button, press the C/F button to change the setting between Fahrenheit and Celsius.
C. Release the TEMPERATURE button to store the new value.

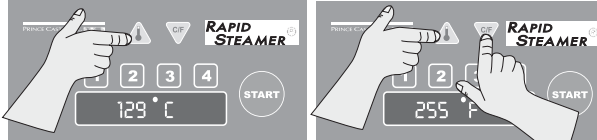

- 2 The CAL TEMP Mode is used to calibrate the platen temperature with an external meter connected to the meter plug inlet on the bottom right side of the unit. Add $\pm 5^{\circ}\text{C}$ ($\pm 10^{\circ}\text{F}$).
A. Press and hold RAPID STEAMER LOGO button and immediately press and hold the TEMPERATURE button. Hold for 6 seconds.
B. The display now shows the current calibration temperature.
C. Press the PRODUCT 2 button to zero any previous calibration offset value. The display will now show the platen temperature without any calibration offset.

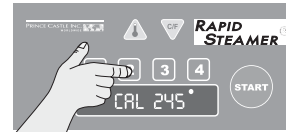

- 3 A. Press the UP or DOWN Arrow button until the temperature readout matches the calibration reading.
B. Press the RAPID STEAMER LOGO button to store the desired calibration and exit CAL TEMP Mode.
NOTE: Pressing the PRODUCT 3 button at any time exits the Program Mode without storing the change.

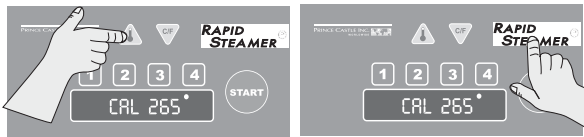

Factory Presets

Loading factory presets restores the unit to factory settings and voids all user programmed information.

- A. During power up, press and hold both PRODUCT 1 and PRODUCT 4 buttons within 3 seconds. The display will flash PRESETS LOADED.

- B. Release both buttons.
625-MCD
Default Factory Presets:
ON OFF Cycles Delay
1.0 3.0 2 2.5

- 625-MFY
Default Factory Presets:
ON OFF Cycles Delay
0.5 1 6 2.5

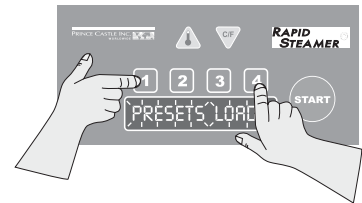

View Firmware Version

Press and hold the RAPID STEAMER LOGO button first, then press and hold the START button. The display will show the current firmware version.

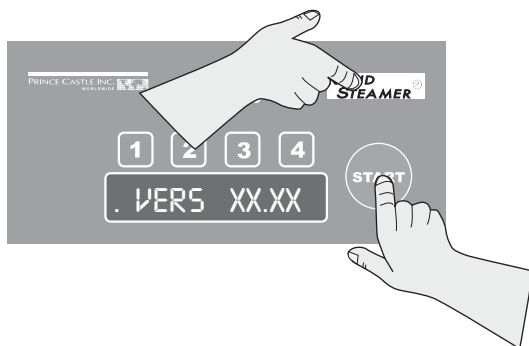

Manual Reset

A hi-limit thermostat will turn off electrical power to the platen and control circuits if the unit overheats.

Turn the unit off and allow to cool (approximately 10 – 15 minutes).

A manual reset is located on the back of the unit. Once the unit has cooled sufficiently, remove the cap and press the manual reset and restart the unit. Replace the manual reset cap.

NOTE: If the unit continues to shut off due to overheating, contact your authorized Prince Castle Service Agency.

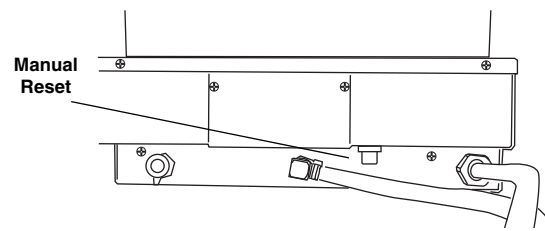

Programming Product Name and Water Cycle

The Program button menus can be changed to any of the following menu items.

PROD1 thru PROD12 can be selected to program additional product names.

"----" can be used when no product name selection is desired.

Filet	Large	PROD1	PROD2	PROD3
PROD4	PROD5	PROD6	PROD7	PROD8
PROD9	PROD10	PROD11	PROD12	----

- 1** A. Press and hold the RAPID STEAMER LOGO button and a PRODUCT button for approximately 6 seconds. The display will show the current assigned product for the button pressed.
NOTE: A decimal point will appear and flash on the right side of the display to indicate Program Mode.

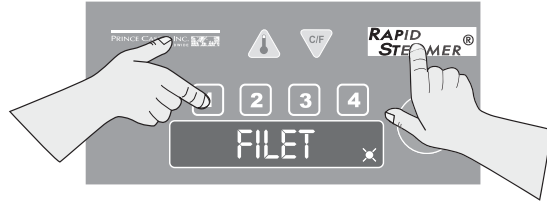

- 2** B. Press the UP or DOWN Arrow button to scroll through the product selections.
C. Press the RAPID STEAMER LOGO button to store the new product name.
To enter custom product names, proceed to Step 3.
NOTE: Pressing the PRODUCT 3 button at any time exits the Program Mode without storing the change.

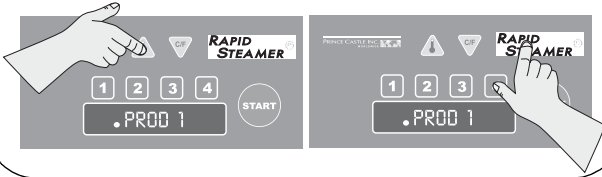

- 3** Press and hold the PRINCE CASTLE LOGO button first, then press and hold the RAPID STEAMER LOGO button for 6 seconds. The display will show the product name with the left-most character display or decimal point flashing.
NOTE: Must be in Program Mode (see Step 1A).

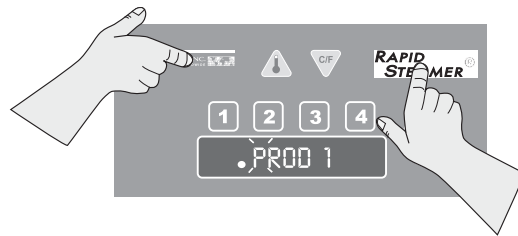

- 4** A. Press the UP or DOWN Arrow button to change the left-most character.
B. Press the PRODUCT 1 or PRODUCT 4 button to move the cursor to the next character.
C. Repeat Steps 4A and 4B for each character.
D. Press the RAPID STEAMER LOGO button to store the new product name.
NOTE: Pressing the PRODUCT 3 button at any time exits the Program Mode without storing the change.

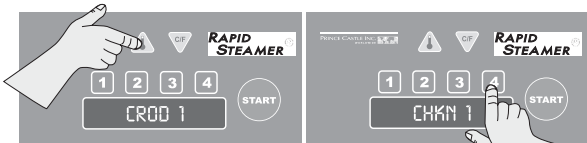

- 5** The display now shows the product's water valve ON time in seconds.



- 6** A. Press the UP or DOWN Arrow button to change the valve ON time.
B. Press the RAPID STEAMER LOGO button to store the new valve ON time.
NOTE: Pressing the PRODUCT 3 button at any time exits the Program Mode without storing the change.

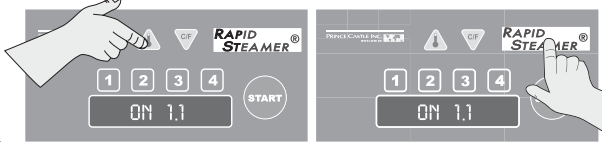

- 7** The display now shows the product's water valve OFF time in seconds.



Programming Product Name and Water Cycle (continued)

- 8** A. Press the UP or DOWN Arrow button to change the valve OFF time.
B. Press the RAPID STEAMER LOGO button to store the new valve OFF time.
NOTE: Pressing the PRODUCT 3 button at any time exits the Program Mode without storing the change.

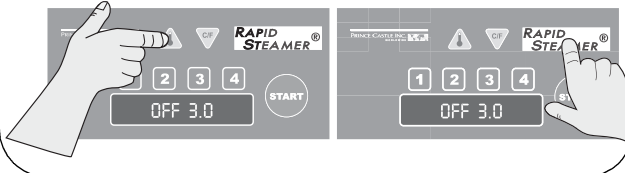

- 9** The display now shows the product's number of on-off water valve cycles.



- 10** A. Press the UP or DOWN Arrow button to change the number of water cycles.
B. Press the RAPID STEAMER LOGO button to store the new water cycle number.
NOTE: Pressing the PRODUCT 3 button at any time exits the Program Mode without storing the change.

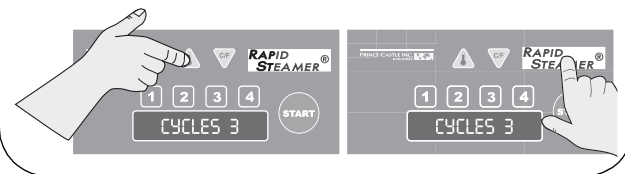

- 11** The display now shows the current product set temperature.



- 12** Platen temperature can be set between 265° – 350°F (129° – 176°C).
A. Press the UP or DOWN Arrow button to scroll to the desired temperature.
B. Press the RAPID STEAMER LOGO button to store the desired temperature.
NOTE: Pressing the PRODUCT 3 button at any time exits the Program Mode without storing the change.

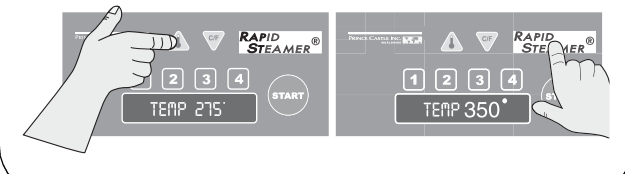

- 13** The display now shows the time delay between when the product is finished and when the alarm sounds. The delay can be set for 0.0 to 10.0 seconds.
A. Press the UP or DOWN Arrow button to scroll to the desired time delay.
B. Press the RAPID STEAMER LOGO button to store the desired time and to exit the Program Mode.
NOTE: Pressing the PRODUCT 3 button at any time exits the Program Mode without storing the change.

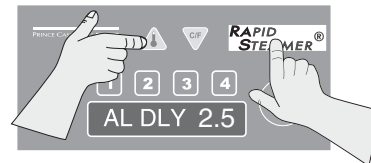

Factory Pre-Set Temperatures

625-MCD Factory pre-set temperatures:
Filet: 305°F (151°C)
Large: 305°F (151°C)
PROD1 – 12: 305°F (151°C)

625-MFY Factory pre-set temperatures:
Filet: 350°F (176°C)
Large: 350°F (176°C)
PROD1 – 12: 350°F (176°C)

Error Messages

Error Messages	Action
No Heat Error.	Call service technician.

Cleaning — Daily PM Tasks

⚠ WARNING

Turn the unit off and unplug the power cord from the electrical receptacle. Proceed with caution, unit is still hot!

⚠ CAUTION

This unit is not watertight. Do not clean with a water jet/jet spray. Do not immerse the unit in water.

Do not use abrasive materials such as scrapers, steel wool, etc. to clean the spatula or steam chamber.

The following equipment is required:

- McD® All Purpose Super Concentrate (APSC)
- McD® Sink Pak Sanitizer McD® APC (Australia only)
- McD® Delimer™ (as required)
- Clean sanitized towel
- Protective (insulated) gloves

- 1** While wearing protective gloves, remove the top cover by pulling up and off the unit.

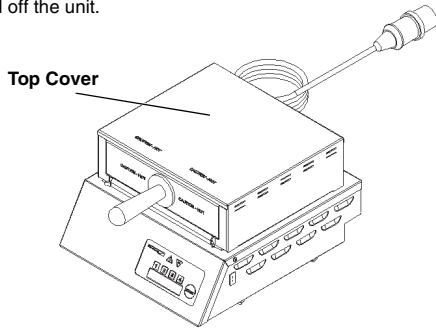

- 2** While wearing protective gloves:

- Remove spatula.
- Remove the top plate by carefully sliding it forward and out of the unit.
- Remove the venturi plate.

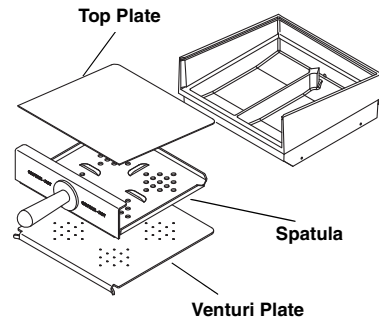

- 3**
- Wash top cover, top plate, and venturi plate in a solution of McD® APSC / APC made up in the back sink.
 - Rinse with clean water, and then sanitize in a solution of McD® Sink Pak Sanitizer.
 - Let air dry.

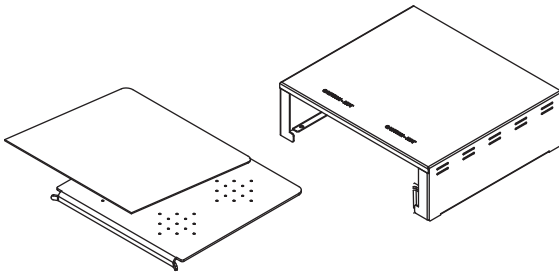

- 4** Wipe the steam chamber surface with a clean sanitized cloth.

OPTIONAL: If the surface shows signs of excessive calcium and lime buildup, dissolve two teaspoons of McD® Delimer™ in a small container (not a drink cup) with 100 ml of water. Pour half on each side. Allow to sit for 5 minutes. Using a clean sanitized towel, thoroughly rinse and wipe the internal surfaces of the steam chamber.

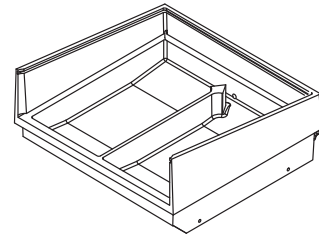

- 5** Use brushes to clean the water tube. Dip the brush in warm water or deliming solution. Insert the brush about 1" into water tube and then remove. Repeat for 30 seconds.

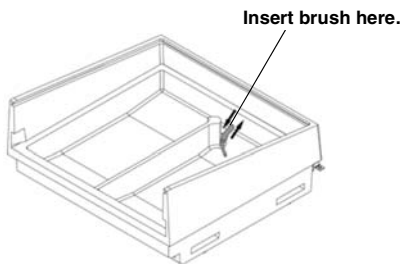

- 6** Wash all external surfaces of the steamer with a solution of McD® APSC / APC. Using the McD® APSC / APC spray bottle, spray directly onto a clean sanitized towel and wipe the unit clean.

⚠ CAUTION

Do not spray directly on the unit or use abrasive cleaners!

Reassemble unit.

Turn the unit on. When unit is preheated, run a minimum of four cycles to prime the unit and remove any residual cleaner.

It is recommended that the steamers go through a deliming procedure at least once a month. Some hard water areas may require daily, weekly, or biweekly deliming based upon actual buildup.

Cleaning — Monthly PM Tasks

WARNING
Turn the unit off and unplug the power cord from the electrical receptacle. Proceed with caution, unit is still hot!

CAUTION
This unit is not watertight. Do not clean with a water jet/jet spray. Do not immerse the unit in water.
Do not use abrasive materials such as scrapers, steel wool, etc. to clean the spatula or steam chamber.

The following equipment is required:

- McD® All Purpose Super Concentrate (APSC)
- McD® Sink Pak Sanitizer McD® APC (Australia only)
- McD® Delimer™ (as required)
- Clean sanitized towel
- Protective (insulated) gloves

1 While wearing protective gloves, remove the top cover by pulling up and off the unit.

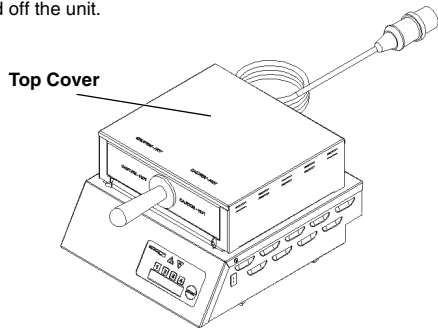

2 While wearing protective gloves:

- A. Remove spatula.
- B. Remove the top plate by carefully sliding it forward and out of the unit.
- C. Remove the venturi plate.

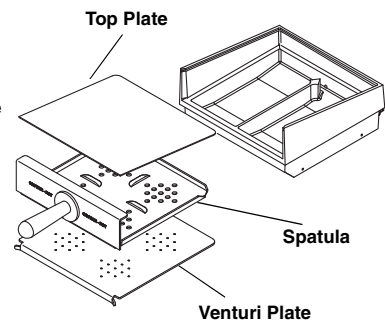

- 3**
- A. Wash top cover, top plate, spatula, and venturi plate in a solution of McD® APSC / APC made up in the back sink.
 - B. Rinse with clean water, and then sanitize in a solution of McD® Sink Pak Sanitizer.
 - C. Let air dry.

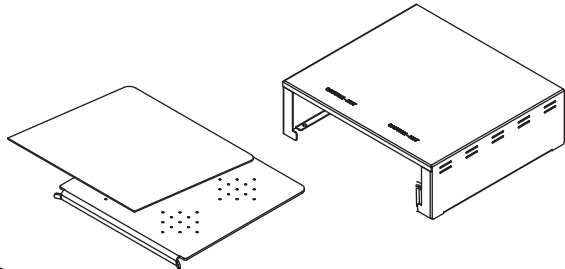

- 4** Pour a solution of McD® Delimer™ (one packet per 16 oz. of hot water) into the steam chamber. Let solution soak for at least 15 minutes. Continue with next step while soaking.

NOTE: Use one packet for monthly cleaning procedure and dispose of the unused solution once the procedure is completed.
In hard water areas that require daily, bi-weekly or weekly cleaning, it is possible to use partial packets. Two teaspoons of McD® Delimer™ can be dissolved in a small container (not a drink cup) with 100 ml of hot water. The packet can be used for 4 applications.

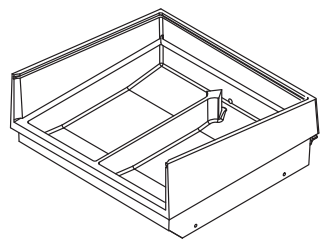

IMPORTANT: It is not recommended to leave open packets lying around.

- 5**
- A. Use brushes to clean the water tube.
 - B. Dip the brush in warm water or deliming solution. Insert the brush about 1" into water tube and then remove.
 - C. Repeat for 30 seconds.

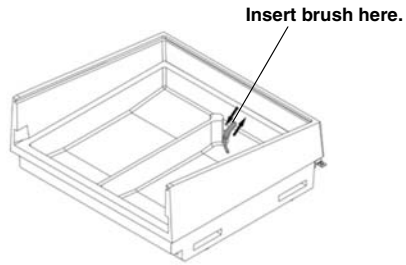

- 6**
- A. Rinse with clean water.
 - B. Wash all external surfaces of the steamer with a solution of McD® APSC / APC. Using the McD® APSC / APC spray bottle, spray directly onto a clean sanitized towel and wipe the unit clean.
 - C. Reassemble the unit.

CAUTION

Do not spray directly on the unit or use abrasive cleaners!
NOTE: In areas that are affected by very hard water, a reverse osmosis (RO) water filtration system is an option to reduce accumulation of mineral deposits in the steamer. Contact either Cuno, KES or Coca-Cola for recommendations.

Exploded View and Parts List

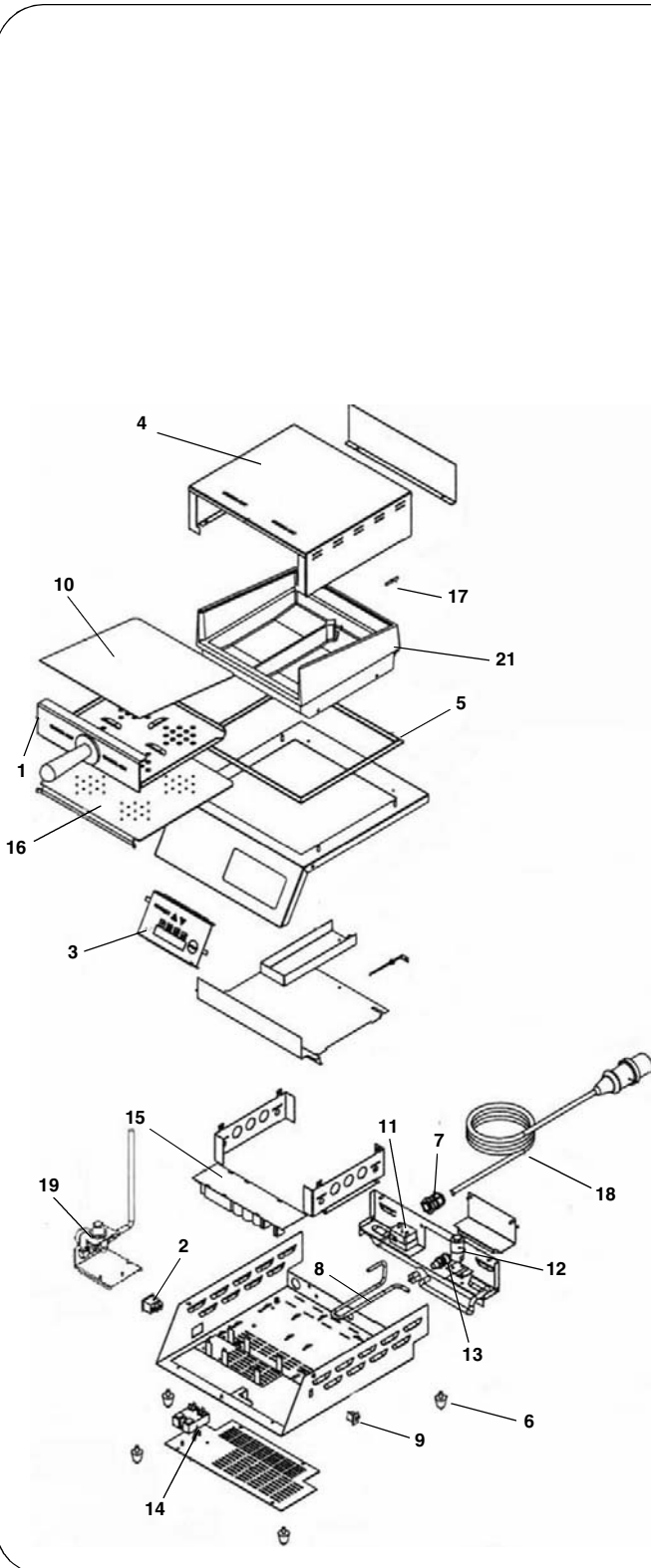

Ref.	Part No.	Description
1	625-128S	Spatula Assembly
	625-097S	Spatula Handle Kit
2	78-233S	Rocker Switch, 20A
3	625-193S	Membrane Switch Assembly
	625-204S	Display (Control), PCB, 625-MFY
	625-205S	Display (Control), PCB, 625-MCD
	625-222S	Display (Control), PCB, 625-MCDA & 625-MCDA16
4	625-158S	Top Cover
5	625-130S	Silicone Gasket
6	197-232S	Feet (Pkg of 4)
7	66-045S	Strain Relief
8	625-357S	Water Dispensing Tube Kit
9	88-497S	Mini-Jack, Type K
10	625-064S	Top Plate
11	625-207S	High-Limit Thermostat
12	625-319N	Water Valve Assembly
13	625-318S	Water Connector Kit
14	65-059S	Relay, 625-MFY
	65-061S	Relay, 625-MCD, 625-MCDA, 625-MCDA16
15	625-323S	Main Power PCB
16	625-065S	Venturi Plate
17	625-082S	Temperature Probe, 1000 ohm RTD
18*	72-386S	Line Cord Assembly, 625-MFY
	72-392S	Line Cord Assembly, 625-MFYT
	72-381S	Line Cord Assembly, 625-MCD
	72-379S	Line Cord Assembly, 625-MCDA
	72-383S	Line Cord Assembly, 625-MCDA16
19	625-253S	Regulator Assembly, 625-MFY
	625-330S or 625-104S	Regulator Assembly, 625-MCD (Optional Accessory)
	625-165S	Regulator Assembly, 625-MCDA & MCDA16 (Optional Accessory)
21	625-285S	Platen, 625-MFY
	625-284S	Platen, 625-MCD
625-253S Regulator Parts (Not Shown)		
	86-359S	Male Quick Disconnect Fitting
	86-365S	Water Strainer Assembly
**	95-1249-12S	Ribbon Cable
**	88-600-200S	Fuse
**	625-364S	Dual Steamer Interconnect, MCD/C
**	625-244	Dual Steamer Interconnect, MFY/G
**	625-103S	Coiled Tubing
**	88-787S	Fuse Holder
**	86-329S	Tubing
**	625-078S	Panel Mount Fitting
**	524-164	Guard Switch
**	625-342S	O-Ring
**	625-320S	Cover Backplate

* NOTE: From Model 625-MCDNZ, units are shipped without a plug.
** Parts Not Shown

Troubleshooting Guide

PROBLEM	PROBABLE CAUSE	SOLUTION
Unit will not heat up; "DISPLAY" is lit. On/Off switch is ON.	Loose connections.	Check continuity wiring.
Unit heats up but will not steam. Display reads "REMOVE" at end of cycle.	Water supply is not connected or shut off. Regulator has pressure set too low.	Disconnect water line and check if water is flowing through main water supply. Check water pressure at regulator to ensure unit is receiving water.
	Water delivery tube clogged.	Replace water tube.
	Defective main PC board or water solenoid.	Call service technician.
	Water supply line is pinched.	Straighten water line.
Unit steams continuously.	Defective main PC board or water solenoid.	Call service technician.
Unit is flooded.	Water pressure too high.	Turn input water regulator to between 20 and 30 psi.
	Defective platen, water solenoid or relay.	Call service technician.
Bun temperature is too cold.	Water pressure too low.	Turn input water regulator to between 20 and 30 psi.
	Not enough water CYCLES.	Check for proper programming of Filet steam cycles. Increase number of CYCLES until desired results are reached.
	Water ON cycle too short.	Check for proper programming of Filet steam cycles. Increase ON time until desired results are reached.
	Partially clogged water tube.	Clean/delime the water tube.
Bun temperature is too hot.	Water pressure too high.	Turn input water regulator to between 20 and 30 psi.
	Water ON cycle too long.	Check for proper programming of Filet steam cycles. Decrease ON time until desired results are reached.
	Too many water CYCLES.	Check for proper programming of Filet steam cycles. Decrease number of CYCLES until desired results are reached.
Not enough moisture in bun.	Water pressure too low.	Turn input water regulator to between 20 and 30 psi.
	Platen not hot enough.	Increase platen temperature.
	Water ON cycle too short.	Check for proper programming of Filet steam cycles. Increase ON time until desired results are reached.
	Not enough water CYCLES.	Check for proper programming of Filet steam cycles. Increase number of CYCLES until desired results are reached.
	Water OFF cycle is too short/long.	Check for proper programming of Filet steam cycles. Increase/decrease OFF time until desired results are reached.
	Partially clogged water tube.	Clean/delime water tube.
	Out-of-date buns.	Use fresh buns.
Too much moisture in bun.	Water pressure too high.	Turn input water regulator to between 20 and 30 psi.
	Water ON cycle too long.	Check for proper programming of Filet steam cycles. Decrease ON time until desired results are reached.
	Too many water CYCLES.	Check for proper programming of Filet steam cycles. Decrease number of CYCLES until desired results are reached.
	Water OFF too long/short.	Check for proper programming of Filet steam cycles. Decrease/increase OFF time until desired results are reached.
Water is leaking from behind the unit.	Water tube not properly pushed into valve.	Completely push tube into valve until you feel it click.
	Faulty water valve.	Call service technician.
Bun sticking to spatula.	Spatula cool.	Keep in steamer between uses.
	Spatula surface compromised.	Replace spatula, do not clean with abrasive pad or cleaners.

Wiring Diagram

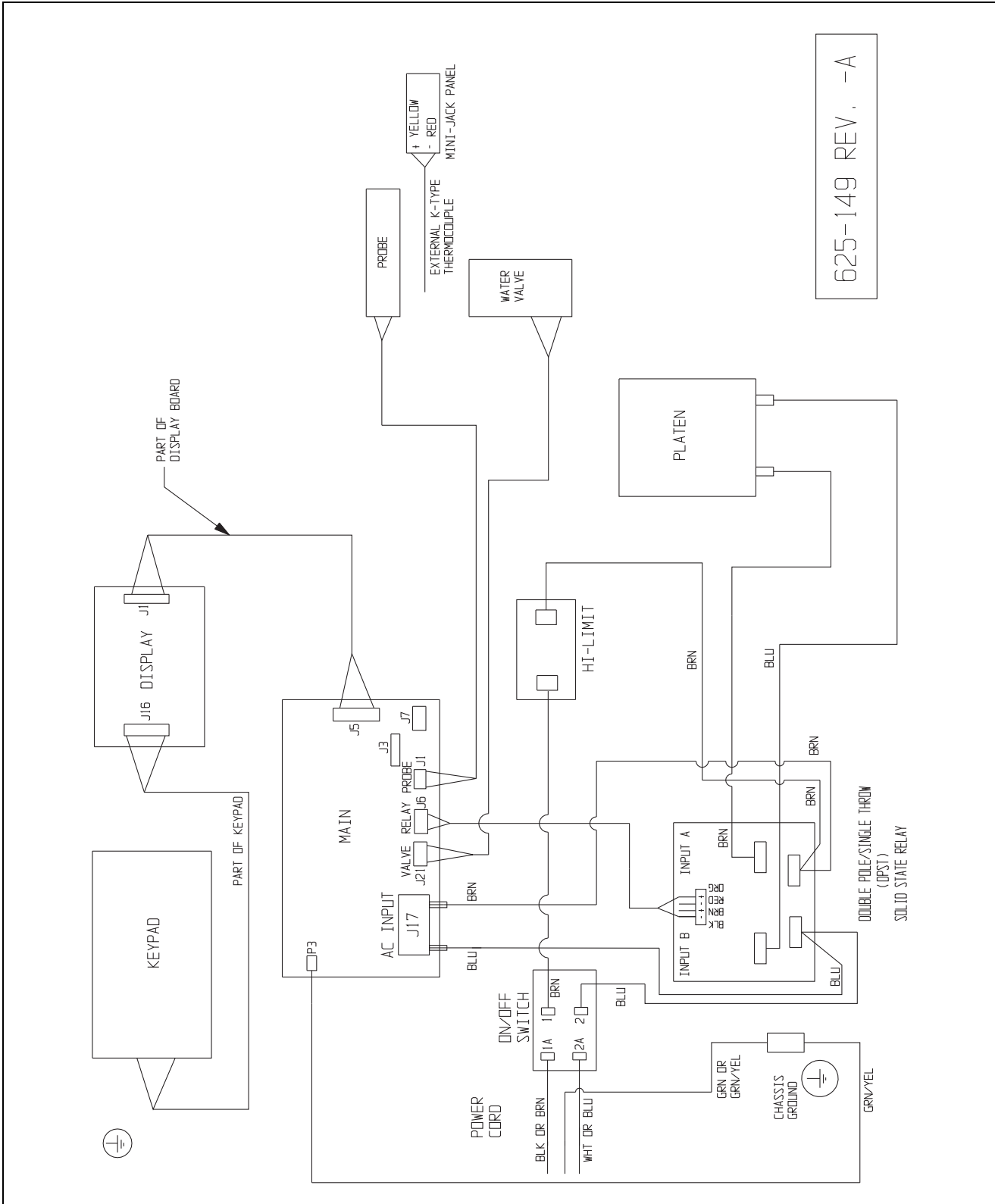

Water Tube Replacement

Stores that have harder water in their areas may experience scale buildup in their water tubes, thus clogging the tube and preventing water from being dispensed into the steaming chamber. If the tube needs to be replaced, this sheet will illustrate how to replace the water tube.

1 First, turn off and unplug steamer. Let steamer cool down. To remove the rear cover plate that shields the water tube, use a Phillips head screwdriver to remove the two screws. Next, take off the rear cover plate to access the water tube.



4 To insert the new tube, first insert the top end through the hole that leads to the platen. The tube will fit through the insulating bushing.

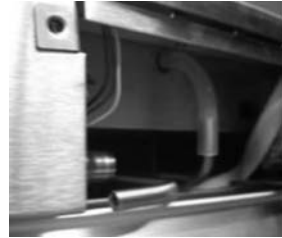

2 To pull the tube out from the water valve, push in the grey disk on the water valve and then slowly slide the tube from the water valve.



5 Push the other end of the tube into the water valve. Ensure that you feel it click into place. Gently tug on the water tube to check if it is secure. If the tube slides out, reinstall the tube. If tube is improperly installed, water will leak at this point.



3 Using pliers, gently pull the tube out from the platen. You may need to softly rock it back and forth. Replace the black insulating bushing if the original bushing pulled out with the water tube. All units must have a bushing installed. To reinstall the bushing, lubricate it with water and push it back into the opening.

CAUTION

Platen must be cool.

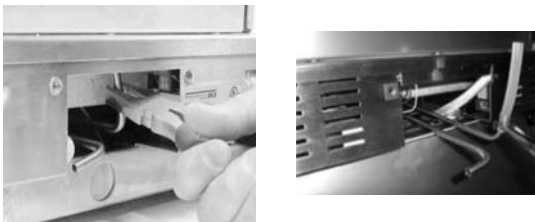

6 Finally, reinstall the rear cover plate. Turn on unit and begin a water cycle to check for leaking at the water valve. If leaking occurs at the back panel of the steamer, turn off unit and repeat Step 5.



Prince Castle Bun Steamer

Model 625-MFY

Daily maintenance tasks

- PR 30 D1 Check water pressure and supply line
- PR 30 D2 Clean water tube

Monthly maintenance tasks

- PR 30 M1 Delime bun steamer

Model 625-MFY

**△ Hazards**

These icons alert you to a possible risk of personal injury.

▨ Equipment alerts

Look for this icon to find information about how to avoid damaging the equipment while doing a procedure.

★ Tips

Look for this icon to find helpful tips about how to do a procedure.

Why	To prevent water damage to internal components of steamer	
Time required	0 minutes to prepare	2 minutes to complete
Time of day	At equipment start-up	For 24-hour restaurants: at equipment start-up
Hazard icons		

Tools and supplies

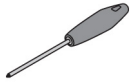

Screwdriver, Phillips

Procedure

1 Turn steamer on.



2 Check water pressure.

Check the water pressure shown on the gauge on the water regulator. The gauge should show water pressure at 20 to 30 psi (1.4 to 2.1 bar).

If water pressure is below 20 psi (1.4 bar), lift knob on water regulator. Turn to the right. Push the knob back down

If water pressure is above 30 psi (2.1 bar), lift knob on water regulator. Turn to the left. Push the knob back down.

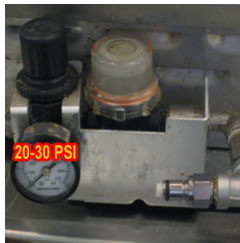

3 Check water supply lines.

Look at the water supply lines running from the ceiling to the steamer. There should be no kinks or bends in the lines.

To remove kinks, pull the water line straight.



4 Check for water leaks.



Look for puddles of water on or near the steamer. Puddles can indicate a leak. Check the toaster table shelf, the water regulator, and where the supply line attaches to the water regulator.

A leak will cause a puddle of water near the steamer. Find where the puddle is.

If it is behind the steamer, check the connection between the water valve and tube.

If it is under the water regulator, check the o-ring on the connector.



Why	To extend the life of the water tube and to prevent damage to internal components	
Time required	5 minutes to prepare	5 minutes to complete
Time of day	At open	For 24-hour restaurants: during breakfast menu
Hazard icons	 Chemicals  Electricity  Hot Surfaces	

Tools and supplies



Procedure

- 1 Turn off and unplug steamer. Turn the steamer off. Unplug the unit. Let the steamer cool for at least 5 minutes.



Electricity
Unplug the steamer before cleaning the water tube.



Hot Surfaces
Do not attempt to clean a hot steamer.



- 2 Remove top cover, top plate, and venturi plate. Put on neoprene gloves. Remove the top cover, top plate, and venturi plate. Take them to the three-compartment-sink for cleaning.



- 3 Wash, rinse, and sanitize top cover, top plate, and venturi plate.



- 4 Check platen for lime build-up. Look for excessive lime build-up on the platen. That is a sign of lime build-up in the water tube.



If you see excessive lime build-up on that platen, mix 2 teaspoons (10 ml) of McD DeLimer solution in 3¹/₂ fluid ounces (100 ml) of water. Pour the solution on the platen. Let the solution soak for 5 minutes.



- 5 Clean water tube. Dip the steamer brush into a gastro norm metal pan filled with warm water. Insert the brush about 1 inch (2.5 cm) into the water tube. Brush the tube for 30 seconds.



continued ►

Clean water tube (continued)

6 Wipe platen.

Wear rubber gloves if the unit is still hot. Mop the solution from the platen with a clean, sanitized towel. Place the towel in the soiled towel bucket.



Chemicals

Sanitizer solution

7 Clean outside of steamer.

Wipe all outside surfaces of the steamer with a clean, sanitized towel saturated with McD APSC. Place the towel in the soiled towel bucket.



Chemicals

McD APSC

8 Reinstall top cover, top plate, and venturi plate.



Reinstall the top cover, top plate, and venturi plate on the steamer.



9 Run steamer for 4 cycles.

Plug the steamer in and turn it on. Run the steamer through 4 cycles before steaming buns.



Why	To prevent lime build-up that can be deposited on buns or can damage the equipment	
Time required	5 minutes to prepare	15 minutes to complete
Time of day	At open	For 24-hour restaurants: during breakfast menu
Hazard icons	 Chemicals	 Hot Surfaces

Tools and supplies



Brush, steamer



Bucket, clean and sanitized towels



Bucket, soiled towels



Gastro norm metal pan



Gloves, neoprene



McD All Purpose Super Concentrate (APSC) solution



McD DeLimer

Procedure

- 1 Turn off and unplug steamer.**
Turn the steamer off. Unplug the unit. Let the steamer cool for at least 5 minutes.



Hot Surfaces
Do not delime a hot steamer.



- 4 Wash, rinse, and sanitize top cover, top plate, and venturi plate.**



- 2 Mix Delimer solution.**
Mix one packet of McD DeLimer in 473 to 600 ml (16 to 20 fluid ounces) of hot water in a gastro norm metal pan.



Chemicals
McD DeLimer



- 5 Pour Delimer solution on platen.**
Pour the Delimer solution on the platen. Let the solution soak for at least 15 minutes. The solution can be left to soak for several hours.



Tip
If there is a heavy build-up of lime, more than 15 minutes of soaking will probably be required.

- 3 Remove top cover, top plate, and venturi plate.**
Put on neoprene gloves. Remove the top cover, top plate, and venturi plate. Take them to the three-compartment- sink for cleaning.



- 6 Clean water tube.**
Dip the steamer brush into a gastro norm metal pan filled with warm water. Insert the brush about 2,5 cm (1 inch) into the water tube. Brush the tube for 30 seconds.



continued ►

7 Wipe platen.

Wear rubber gloves if the unit is still hot. Mop the solution from the platen with a clean, sanitized towel. Place the towel in the soiled towel bucket.

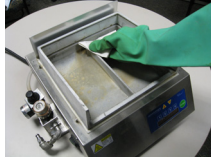

Chemicals

Sanitizer solution

8 Clean outside of steamer.

Wipe all outside surfaces of the steamer with a clean, sanitized towel saturated with McD APSC. Place the towel in the soiled towel bucket.



Chemicals

McD APSC

9 Reinstall top cover, top plate, and venturi plate.

Reinstall the top cover, top plate, and venturi plate on the steamer.

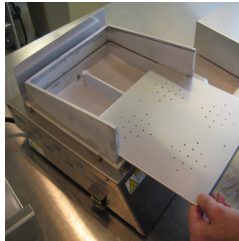

10 Run steamer for 4 cycles.

Plug the steamer in and turn it on. Run the steamer through 4 cycles before steaming buns.



Wiring Diagram (MFYC)

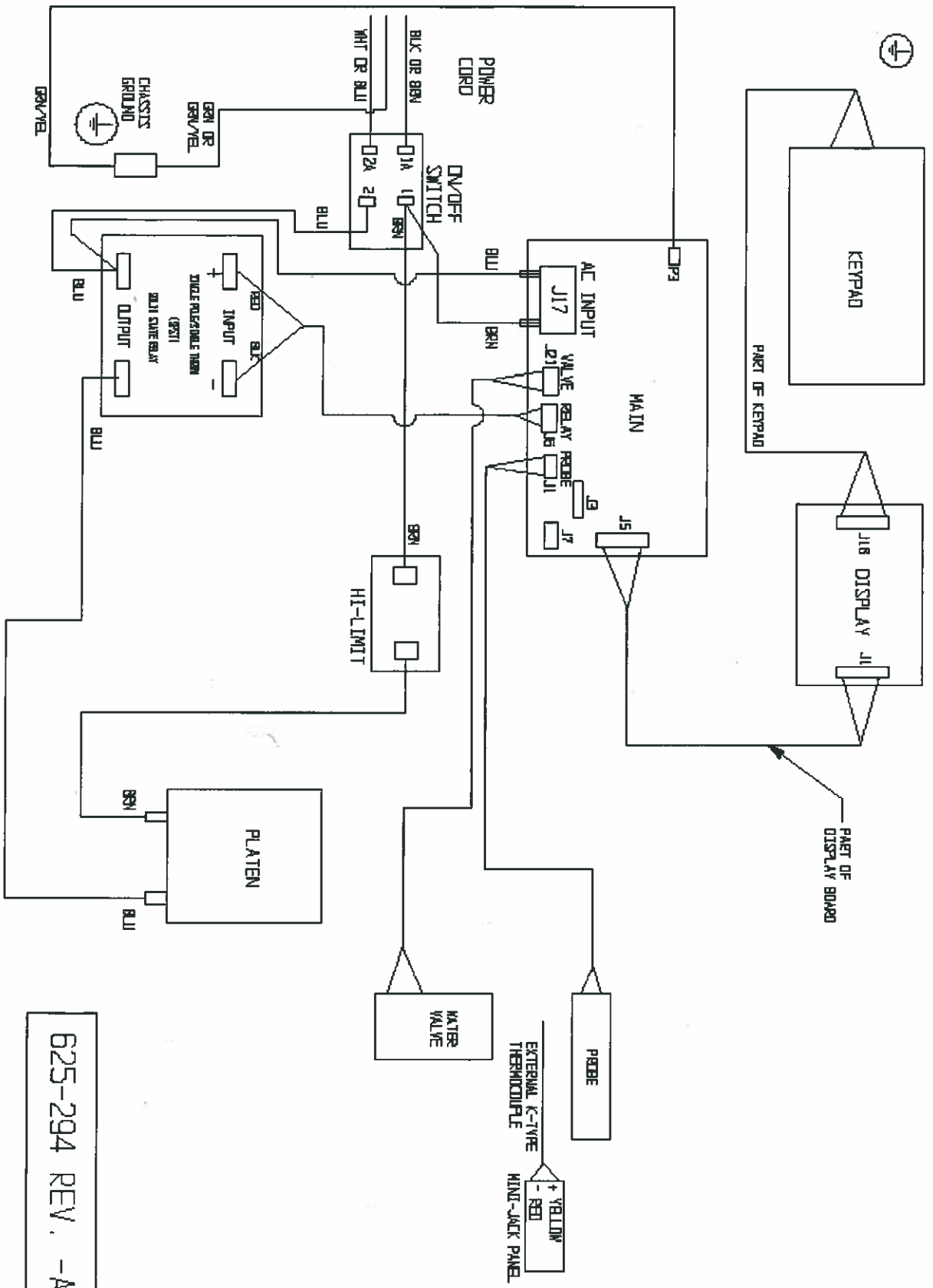

625-294 REV. -A