

OPERATOR'S MANUAL

This manual provides information on installation, operating, maintenance, trouble shooting & replacement parts for

FULL VIEW DROP-IN REFRIGERATED DISPLAY CASE

44250DIMA

44262DIMA

44274DIMA

44250DIPA

44262DIPA

44274DIPA

44250DISA

44262DISA

44274DISA



NOTIFY CARRIER OF DAMAGE AT ONCE.

It is the responsibility of the consignee to inspect the container upon receipt of same and to determine the possibility of any damage, including concealed damage. Randell suggests that if you are suspicious of damage to make a notation on the delivery receipt. It will be the responsibility of the consignee to file a claim with the carrier. We recommend that you do so at once.

Information contained in this document is known to be current and accurate at the time of printing/creation. Unified Brands recommends referencing our product line websites, unifiedbrands.net, for the most updated product information and specifications.



1055 Mendell Davis Drive, Jackson MS 39272
888-994-7636 • Fax 888-864-7636 • randell.com

Table of Contents

page 2.....	Congratulations
page 3.....	Parts & Service Hotline
page 3.....	Serial Number Location
page 4-6.....	Randell Limited Warranty
page 7.....	Unit Specifications
page 8-9.....	Unit Installation
page 10.....	Electrical Diagrams
page 11.....	Unit Operation
page 12-13.....	Preventive Maintenance
page 14-15.....	Troubleshooting
page 16-17.....	Replacement Parts

Congratulations on your recent purchase of Randell food service equipment, and welcome to the growing family of satisfied Randell customers.

Our reputation for superior products is the result of consistent quality craftsmanship. From the earliest stages of product design to successive steps in fabrication and assembly, rigid standards of excellence are maintained by our staff of designers, engineers, and skilled employees.

Only the finest heavy-duty materials and parts are used in the production of Randell brand equipment. This means that each unit, given proper maintenance will provide years of trouble free service to its owner.

In addition, all Randell food service equipment is backed by some of the best warranties in the food service industry and by our professional staff of service technicians.

Retain this manual for future reference.

NOTICE: Due to a continuous program of product improvement, Randell reserves the right to make changes in design and specifications without prior notice.

NOTICE: Please read the entire manual carefully before installation. If certain recommended procedures are not followed, warranty claims will be denied.

<p>MODEL NUMBER _____</p> <p>SERIAL NUMBER _____</p> <p>INSTALLATION DATE _____</p>
--

The serial number is located on the interior left side of the refrigerated case.

800-621-8560

**Randell Service and Parts
Hotline**

Warranty Policies

Congratulations on your purchase of a Randell piece of equipment. Randell believes strongly in the products it builds and backs them with the best warranty in the industry. Standard with every unit comes the peace of mind that this unit has been thoroughly engineered, properly tested and manufactured to excruciating tolerances, by a manufacturer with over 30 years of industry presence. On top of that front end commitment, Randell has a dedicated staff of certified technicians that monitor our own technical service hotline at **1-800-621-8560** to assist you with any questions or concerns that may arise after delivery of your new Randell equipment.

PARTS WARRANTY

1. One year parts replacement of any and all parts that are found defective in material or workmanship. Randell warrants all component parts of manufactured new equipment to be free of defects in material or workmanship, and that the equipment meets or exceeds reasonable industry standards of performance for a period of one year from the date of shipment from any Randell factory, assembly plant or warehouse facility.

NOTE: Warranties are effective from date of shipment, with a thirty day window to allow for shipment, installation and set-up. In the event equipment was shipped to a site other than the final installation site, Randell will warranty for a period of three months following installation, with proof of starting date, up to a maximum of fifteen months from the date of purchase.

2. Free ground freight of customer specified location for all in warranty parts within continental U.S. Component part warranty does not cover glass breakage or gasket replacement. Randell covers all shipping cost related to component part warranty sent at regular ground rates (UPS, USPS). **Freight or postage incurred for any express or specialty methods of shipping are the responsibility of the customer.**

LABOR COVERAGE

In the unlikely event a Randell unit fails due to defects in materials or workmanship within the first ninety days, Randell agrees to pay the contracted labor rate performed by an **Authorized Service Agent (ASA)**. Any work performed by a non-ASA will not be honored by Randell. Please consult Randell Technical Support (800-621-8560) for a complete listing of ASAs. Warranties are effective from date of shipment, with a thirty day window to allow for shipment, installation and setup. Where equipment is shipped to any site other than final installation, Randell will honor the labor warranty for a period of ninety days following installation with proof of starting date, up to a maximum of six months from date of purchase.

Temperature adjustments are not covered under warranty, due to the wide range of ambient conditions.

To request a warranty approval number, call our Field Service Department at: 1-800-621-8560

WHEN OPTIONAL 5 YEAR COMPRESSOR WARRANTY APPLIES

1. Provide reimbursement to an ASA for the cost of locally obtained replacement compressor in exchange for the return of the defective compressor sent back freight prepaid. Note: Randell does limit amount of reimbursement allowed and does require bill from local supply house where compressor was obtained (customer should not pay servicing agent up front for compressor).
2. Provide repair at the manufacturing facility by requiring that the defective unit be sent back to Randell freight prepaid. Perform repair at the expense of Randell and ship the item back to the customer freight collect.
3. Furnish complete condensing unit freight collect in exchange for the return of the defective compressor sent back freight prepaid. (Decisions on whether or not to send complete condensing units will be made by Randell's in-house service technician).

WHEN OPTIONAL LABOR EXTENSION POLICY APPLIES

Randell will provide reimbursement of labor invoiced to any customer that has an optional labor extension of our standard warranty. (Reasonable geographic and industry rates do apply) Randell offers both 1 and 2 year extensions. Labor extensions begin at the end of our standard warranty and extend out 9 months to 1 calendar year or 21 months to 2 calendar years from date of purchase. Please contact Randell's technical service hotline at 1-800-621-8560 for details and warranty authorization numbers.

WHEN EXPORT WARRANTIES APPLY

1. Randell covers all non-electrical components under the same guidelines as our standard domestic policy.
2. All electrical components operated on 60 cycle power are covered under our standard domestic policy.
3. All electrical components operated on 50 cycle power are covered for 90 days from shipment only.
4. Extended warranty options are not available from the factory.

ITEMS NOT COVERED UNDER WARRANTY

1. Maintenance type of repairs such as condenser cleaning, temperature adjustments, clogged drains and unit leveling.
2. Randell does not cover gaskets under warranty. Gaskets are a maintenance type component that are subject to daily wear and tear and are the responsibility of the owner of the equipment. Because of the unlimited number of customer related circumstances that can cause gasket failure all gasket replacement issues are considered non-warranty. Randell recommends thorough cleaning of gaskets on a weekly basis with a mild dish soap and warm water. With proper care Randell gaskets can last up to two years, at which time we recommend

replacement of all gaskets on the equipment for the best possible performance.

NOTICE: FOOD LOSS IS NOT COVERED UNDER WARRANTY

3. Repairs caused by abuse such as broken glass, freight damage, or scratches and dents.
4. Electrical component failure due to water damage from cleaning procedures.

DAMAGES

All crating conforms to general motor carrier specifications. To avoid concealed damage, we recommend inspection of every carton upon receipt. In the event the item shows rough handling or visible damage to minimize liability, a full inspection is necessary upon arrival. Appearance of damage will require removing the crate in the presence of the driver. **A notation must be placed on the freight bill and signed for by the truck driver at the time of delivery.** Any and all freight damage that occurs to a Randell piece of equipment as a result of carrier handling is not considered under warranty, and is not covered under warranty guidelines. Any freight damage incurred during shipping needs to have a freight claim filed by the receiver with the shipping carrier. Consignee is responsible for filing of freight claims when a clear delivery receipt is signed. Claims for damages must be filed immediately (within 10 days) by the consignee with the freight carrier and all cartons and merchandise must be retained for inspection.

RETURNED GOODS

Authorization for return must first be obtained from Randell before returning any merchandise. Any returned goods shipment lacking the return authorization number will be refused, all additional freight costs to be borne by the returning party. Returned equipment must be shipped in original carton, freight prepaid and received in good conditions. Any returned merchandise is subject to a minimum handling charge (consult factory for rate).

INSTALLATION

Equipment installation is the responsibility of the dealer and/or their customer. Randell requires all equipment to be professionally installed.

*FOOTNOTES IN REFERENCE TO PARAGRAPHS ABOVE

1. Herein called Randell.

2. NET means list price less discount, warranty, labor policy, freight, Randell delivery and other miscellaneous charges.

CASH DISCOUNTS WILL BE CALCULATED ON NET ONLY.

Unit Specifications



44250DIMA shown

Model	L	D	H	Style	Capacity Cu. Ft.	H. P.	Volts	Amp	NEMA
44250DIMA	50"	25.25"	44"*	Single Service, Mirrored Back	20.1	3/8	115/60/1	6.5	5-15P
44262DIMA	62"	25.25"	44"*	Single Service, Mirrored Back	25.5	1/2	115/60/1	8.8	5-15P
44274DIMA	74"	25.25"	44"*	Single Service, Mirrored Back	31.1	1/2	115/60/1	8.8	5-15P
44250DIPA	50"	26.5"	44"*	Double Service, Pass-Thru	20.1	3/8	115/60/1	6.5	5-15P
44262DIPA	62"	26.5"	44"*	Double Service, Pass-Thru	25.5	1/2	115/60/1	8.8	5-15P
44274DIPA	74"	26.5"	44"*	Double Service, Pass-Thru	31.1	1/2	115/60/1	8.8	5-15P
44250DISA	50"	25.25"	44"*	Single Service, See-Thru	20.1	3/8	115/60/1	6.5	5-15P
44262DISA	62"	25.25"	44"*	Single Service, See-Thru	25.5	1/2	115/60/1	8.8	5-15P
44274DISA	74"	25.25"	44"*	Single Service, See-Thru	31.1	1/2	115/60/1	8.8	5-15P

* 44" is the height of the unit above counter top. Overall height including the compressor housing is 62".

Unit Installation

SELECTING A LOCATION FOR YOUR NEW UNIT

The following conditions should be considered when selecting a location for your unit:

1. **Floor and Countertop Load:** The area on which the unit will rest must be level, free of vibration, and suitably strong enough to support the combined weights of the unit plus the maximum product load weight.
NOTE: If there is a question pertaining to weight load limits, consult the factory at 1-800-621-8560.
2. **Clearance:** There must be a combined total of at least 3" clearance on all sides of the unit.
3. **Ventilation:** The air cooled self contained unit requires a sufficient amount of cool clean air. Ensure the cabinet holding the drop-in display case is properly vented. Avoid surrounding your display case around other heat generating equipment and out of direct sunlight. Also, avoid locating in an unheated room or where the room temperature may drop below 55° F (13°C) or about 90° F (32°C).

INSTALLATION CHECKLIST

After the final location has been determined, refer to the following checklist prior to start-up:

1. Check all exposed refrigeration lines to ensure that they are not kinked, dented, or rubbing together.
2. Check that the condenser and evaporator fans rotate freely without striking any stationary members.
3. Plug in unit and turn on main on/off power switch.
4. Allow unit time to cool down to temperature. If temperature adjustments are required, the temperature control can be accessed through the hole on top of the unit.
5. Refer to the front of this manual for serial number location. Please record this information in your manual on page 3 now. It will be necessary when ordering replacement parts or requesting warranty service.
6. Confirm that the unit is holding temperature. Set controls to desired temperature for your particular ambient and altitude.
7. Allow your unit to operate for approximately 2 hours before putting in food to allow interior of unit to cool down to storage temperature.

NOTE: All motors are oiled and sealed.

NOTE: FAILURE TO FOLLOW INSTALLATION GUIDELINES AND RECOMMENDATIONS MAY VOID THE WARRANTY ON YOUR UNIT.

ELECTRICAL SUPPLY: The wiring should be done by a qualified electrician in accordance with local electrical codes. A properly wired and grounded outlet will assure proper operation. Please consult the data tag attached to the compressor to ascertain the correct electrical requirements. Supply voltage and amperage

requirements are located on the serial number tag located inside the mechanical housing.

NOTE: It is important that a voltage reading be made at the compressor motor electrical connections, while the unit is in operation to verify the correct voltage required by the compressor is being supplied. Low or high voltage can detrimentally affect operation and thereby void its warranty.

NOTE: it is important that your unit has its own dedicated line. Condensing units are designed to operate with a voltage fluctuation of plus or minus 10% of the voltage indicated on the unit data tag. Burn out of a condensing unit due to exceeding voltage limits will void the warranty.

Electrical Diagram

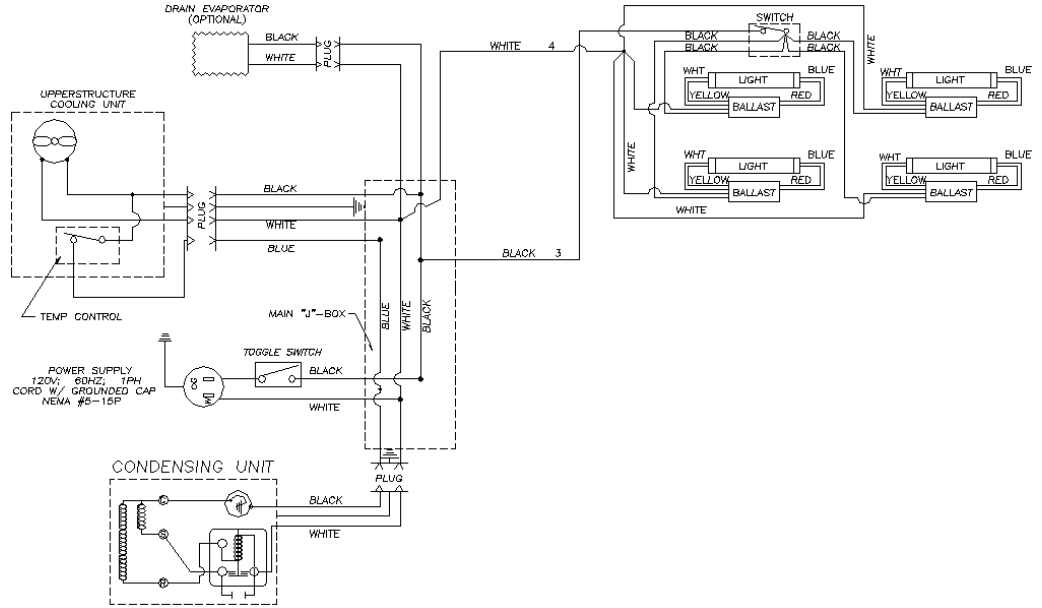

Unit Operation

Randell has attempted to preset the cold controls to ensure that your unit runs at an optimum temperature, but due to varying ambient conditions, including elevation, food product as well as type of operation, you may need to alter this temperature.

It is strongly recommended that the doors be kept closed when the unit is not in use and between rush periods. This is especially important in the summer and in kitchens exceeding 80° F. Do not leave the doors open for prolonged periods of time. Close after using.

NOTE: Even though your drop-in display case was designed for heavy use, excessive door openings should be avoided in order to maintain proper cabinet temperature and eliminate the possibility of coil freeze-up.

Your drop-in display case was equipped with a temperature adjustment control located within the cabinet on the front face of the evaporator coil.

To adjust the temperature in refrigerated units:

A. To lower the temperature:

1. Turn the dial knob clockwise.
2. There are numbers to indicate settings. Keep the arrow on the knob pointed within the numbered section of the arc.
3. Turning it clockwise beyond the numbered section can result in freeze-up.

B. To raise the temperature:

1. Turn the dial knob counterclockwise.
2. There are numbers to indicate settings. Keep the arrow on the knob pointed within the numbered section of the arc.
3. Turning it counterclockwise beyond the numbered section will shut the compressor off.

NOTE: It is not recommended to turn the dial above 8 or below 1 on the temperature control. If the adjustments still do not result in proper temperature please contact the factory at 1-800-621-8560.

C. If your temperature control is at the maximum setting and the cabinet temperature still remains too low or too high, you may need to adjust the pressure control if your display case is equipped with one.

1. Turn the right adjustment screw clockwise (1/4 turn at a time) to a lower number for a colder temperature.
2. Turn the right adjustment screw counterclockwise (1/4 turn at a time) to a higher number for a warmer temperature.

NOTE: Numbers on pressure control are pounds of pressure, not degrees F.

NOTE: Do not adjust the differential screw.

Preventive Maintenance

Randell strongly suggests a preventive maintenance program which would include the following **Monthly** procedures:

1. Cleaning of all condenser coils. Condenser coils are a critical component in the life of the compressor and must remain clean to assure proper air flow and heat transfer. Failure to maintain this heat transfer will affect unit performance and eventually destroy the compressor. Clean the condenser coils with coil cleaner and/or a vacuum, cleaner and brush.

NOTE: Brush coil in direction of fins, normally vertically as to not damage or restrict air from passing through condenser.

2. Clean fan blade on the condensing unit.
3. Clean and disinfect drains with a solution of warm water.
4. Clean and disinfect drain lines and evaporator pan with a solution of warm water.
5. Clean all gaskets on a weekly if not daily basis with a solution of warm water and a mild detergent to extend gasket life.

NOTE: DO NOT USE SHARP UTENSILS.

RECOMMENDED CLEANERS FOR YOUR STAINLESS STEEL INCLUDE THE FOLLOWING:

JOB	CLEANING AGENT	COMMENTS
Routine cleaning	Soap, ammonia, detergent Medallion	Apply with a sponge or cloth
Fingerprints and smears	Arcal 20, Lac-O-Nu, Ecoshine	Provides a barrier film
Stubborn stains and discoloration	Cameo, Talc, Zud, First Impression	Rub in the direction of the polish lines
Greasy and fatty acids, blood, burnt-on foods	Easy-Off, Degrease It, Oven Aid	Excellent removal on all finishes
Grease and Oil	Any good commercial detergent	Apply with a sponge or cloth
Restoration/Preservation	Benefit, Super Sheen	Good idea monthly

Reference: Nickel Development Institute, Diversey Lever, Savin, Ecolab, NAFEM.

NOTE: Do not use steel pads, wire brushes, scrapers, or chloride cleaners to clean your stainless steel. CAUTION: DO NOT USE ABRASIVE CLEANING SOLVENTS, AND NEVER USE HYDROCHLORIC ACID (MURIATIC ACID) ON STAINLESS STEEL.

NOTE: Do not pressure wash equipment as damage to electrical components may result.

Preventive Maintenance (cont.)

Proper maintenance of equipment is the ultimate necessity in preventing costly repairs. By evaluating each unit on a regular schedule, you can often catch and repair minor problems before they completely disable the unit and become burdensome on your entire operation.

For more information on preventive maintenance, consult your local service company or CFESA member. Most repair companies offer this service at very reasonable rates to allow you the time you need to run your business along with the peace of mind that all your equipment will last throughout its expected life. These services often offer guarantees as well as the flexibility in scheduling or maintenance for your convenience.

Randell believes strongly in the products it manufactures and backs those products with one of the best warranties in the industry. We believe with the proper maintenance and use, you will realize a profitable return on your investment and years of satisfied service.

Trouble Shooting Guide

SYMPTOM	POSSIBLE CAUSE	PROCEDURE
Unit doesn't run	<ol style="list-style-type: none"> 1. No power to unit 2. Temperature control turned off 3. Temperature control faulty 4. Compressor overheated 5. Condenser fan faulty 6. Overload protector faulty 7. Compressor relay faulty 8. Defrost timer faulty 9. Compressor faulty 	<ol style="list-style-type: none"> 1. Plug in unit 2. Check temperature control 3. Test temperature control 4. Clean condenser coil 5. Service condenser fan 6. Test overload 7. Test relay 8. Test defrost timer 9. Call for service at 800-621-8561
Unit short cycles	<ol style="list-style-type: none"> 1. Condenser coil dirty 2. Condenser fan faulty 3. Compressor faulty 4. Overload repeatedly tripping 	<ol style="list-style-type: none"> 1. Clean coil 2. Service fan and motor. 3. Call for service at 800-621-8561 4. Check outlet voltage
Unit runs constantly	<ol style="list-style-type: none"> 1. Frost build-up 2. Drawer not sealing properly 3. Drawer gasket damaged 4. Condenser coil dirty 5. Condenser fan faulty 	<ol style="list-style-type: none"> 1. Defrost evaporator 2. Check drawer seal 3. Replace drawer gasket 4. Clean coil 5. Service condenser motor
Unit not cold enough	<ol style="list-style-type: none"> 1. Temperature control set too high 2. Temperature control faulty 3. Condenser coil dirty 4. Drawer not sealing properly 5. Drawer gasket damaged 6. Evaporator fan faulty 7. Evaporator iced up 8. Refrigerant leaking or contaminated 	<ol style="list-style-type: none"> 1. Adjust control to lower setting 2. Test control 3. Clean coil 4. Check drawer seal 5. Replace drawer gasket 6. Service evaporator fan 7. Defrost evaporator, test defrost heater, test thermodisc, test defrost timer 8. Call for service at 800-621-8561
Unit too cold	<ol style="list-style-type: none"> 1. Temperature control set too low 2. Temperature control faulty 	<ol style="list-style-type: none"> 1. Adjust control to raise setting 2. Test control
Unit doesn't defrost	<ol style="list-style-type: none"> 1. Defrost heater faulty 2. Defrost thermodisc faulty 3. Defrost timer faulty 	<ol style="list-style-type: none"> 1. Test defrost heater 2. Test thermodisc 3. Test defrost timer
Moisture around	<ol style="list-style-type: none"> 1. Breaker strips faulty 	<ol style="list-style-type: none"> 1. Inspect strips

drawer or frame	<ol style="list-style-type: none"> 2. Frame heater defective 3. Temperature set too low 	<ol style="list-style-type: none"> 2. Call for service at 800-621-8561 3. Raise temperature setting
Ice in drain pan or water in bottom of unit or floor	<ol style="list-style-type: none"> 1. Drain tube clogged 2. Unit not level 	<ol style="list-style-type: none"> 1. Clean drain 2. Adjust leveling leg/shim casters
Unit noisy	<ol style="list-style-type: none"> 1. Unit not level 2. Compressor mountings loose or hardened. 3. Condenser fan damaged or hitting fan shroud 4. Evaporator fan damaged or hitting fan shroud 5. Mechanical compartment louver rattling 	<ol style="list-style-type: none"> 1. Adjust leveling leg/shim casters 2. Tighten or replace compressor mountings 3. Inspect condenser fan 4. Inspect evaporator fan 5. Bend or align tabs to reduce noise. Replace if necessary.

**Replacement
Parts**

**44000 Series
Full View Drop-In Display Case**

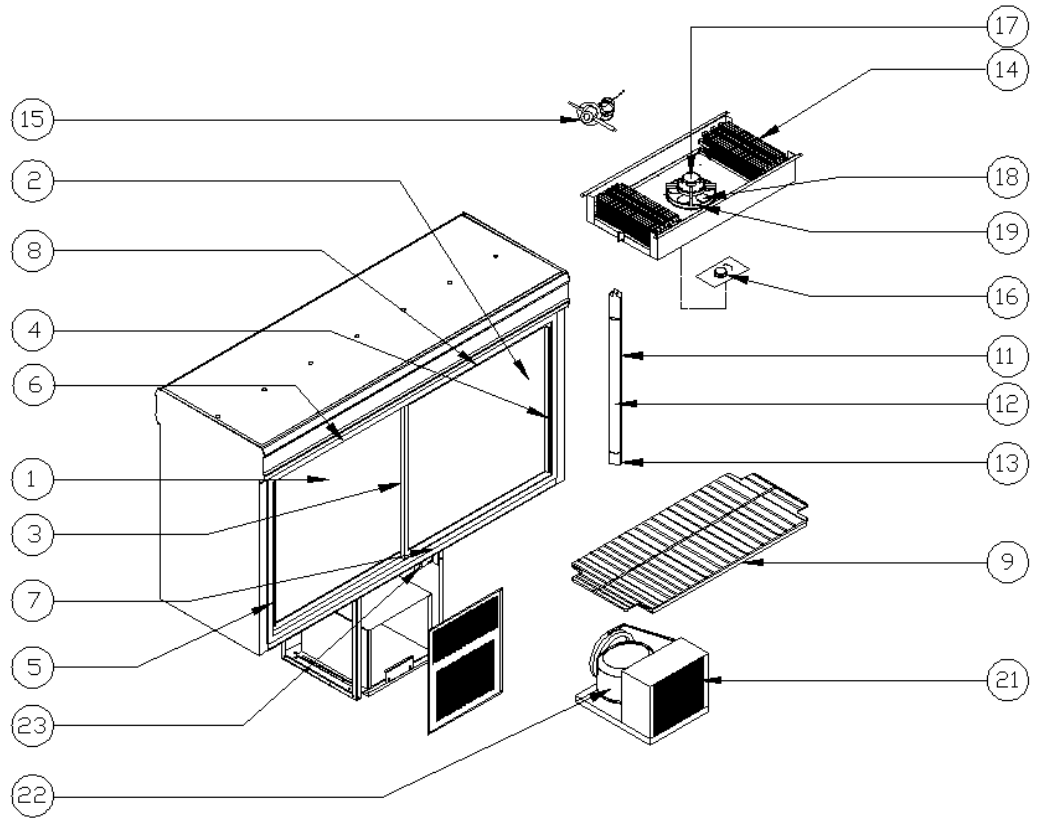

ITEM	DESCRIPTION	PART #	44250DIMA 44250DIPA 44250DISA	44262DIMA 44262DIPA 44262DISA	44274DIMA 44274DIPA 44274DISA
1	Door, Left Sliding	HD DOR058L	X		
1A	Door, Left Sliding	HD DOR062L		X	
1B	Door, Left Sliding	HD DOR074L			X
2	Door, Right Sliding	HD DOR058R	X		
2A	Door, Right Sliding	HD DOR62L		X	
2B	Door, Right Sliding	HD DOR074R			X
3	Wiper Gasket	IN GSK500	X	X	X
4	Bumper Gasket, Right Door	IN GSK501	X	X	X
5	Bumper Gasket, Left Door	IN GSK502	X	X	X
6	Spring, Door Closure	HD SPR050	X		
6A	Spring, Door Closure	HD SPR003		X	
6B	Spring, Door Closure	HD SPR073			X
7	Bearing, Pike Glass Door	HD BRG50P	X	X	X
8	Frame, Plastic for Sliding Doors	HD FRM058	X		
8A	Frame, Plastic for Sliding Doors	HD FRM062		X	
8B	Frame, Plastic for Sliding Doors	HD FRM074			X
9	Shelf, Wire	HD SHL061	X		
9A	Shelf, Wire	HD SHL062		X	
9B	Shelf, Wire	HD SHL063			X
10	Clip, Shelf Support	HD CLP100	X	X	X
11	Light Fixture, 36" Fluorescent	EL LGT036	X	X	X
12	Bulb, Fluorescent, F20T12CW	EL TUB200	X	X	X
13	Shroud, Plastic Bulb Guard	EL SHD360	X	X	X
14	Coil, Evaporator 4" x 6" x 14"	RF COI120B	X	X	X
15	Expansion Valve, R-134A	RF VLV200	X	X	X
16	Thermostat, Cold Control	HD CNT200	X	X	X
17	Motor, Evaporator Fan	EL MTR0102	X	X	X
18	Blade, Evaporator Fan	RF BLD0101	X	X	X
19	Mounting Ring & Guard	RF RNG0201	X	X	X
20	Pan, Evaporator Drip Pan	RP DRP0601	X	X	X
21	Condensing Unit, 3/8 HP Tecumseh, R-134A	RF CON0006	X		
21A	Condensing Unit, 1/2 HP Copeland, R-134A	RF CON0107		X	X
22	Compressor, AEA4448YXA	RF CMP0104P	X		
22A	Compressor, ART62C1E-IAA-901	RF CMP0107		X	X
23	Switch, ON/OFF	EL SWT0501	X	X	X