

3073SQ Parts View

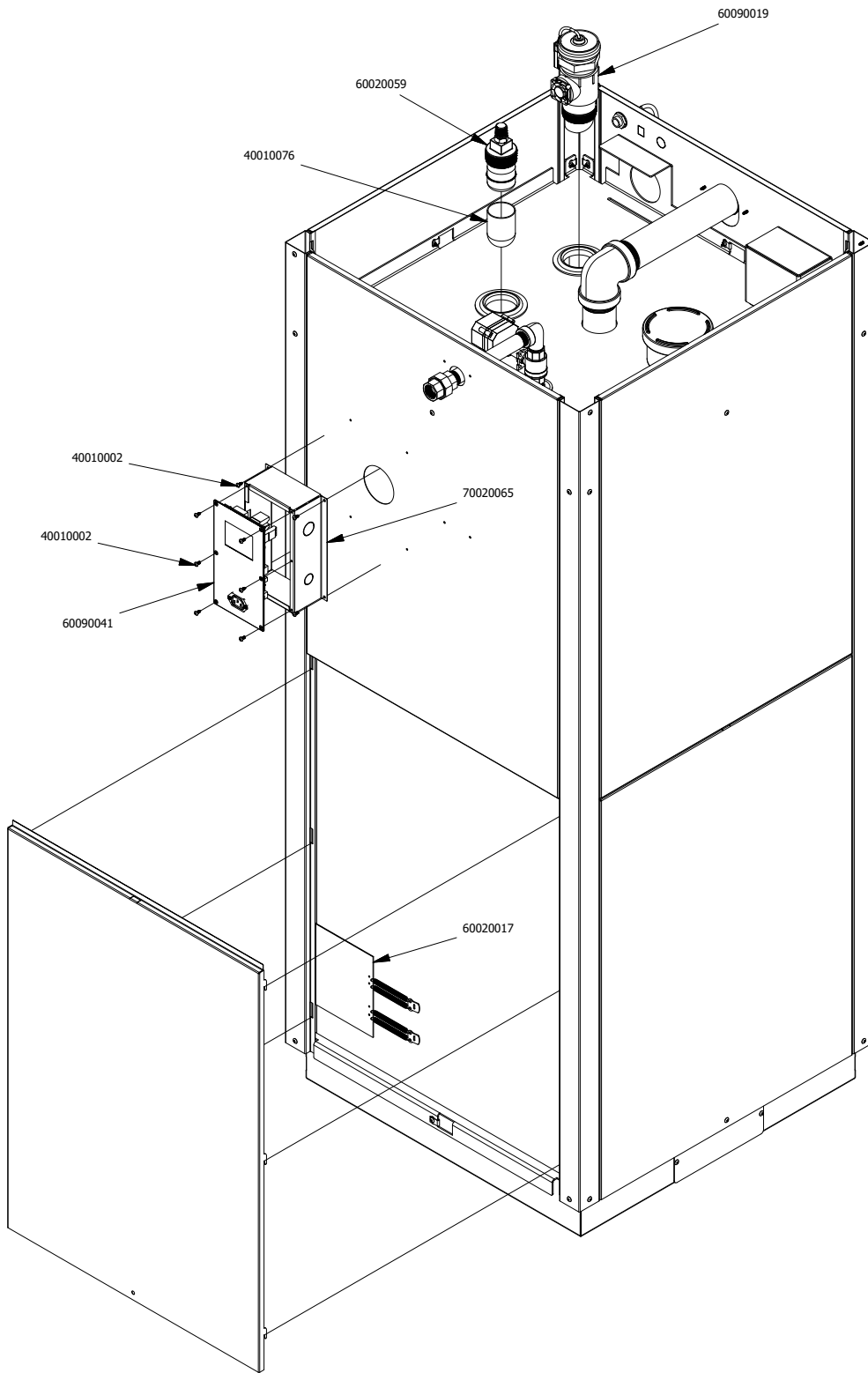

Part Number	Description	Qty	Part Number	Description	Qty
40010076	Silicone Cap for Mechanical Float Sensor	1	60090041	M3 Gen 3 Control Panel assembled & mounted for NA	1
60020017	120V 350W Heater Belt	1	40010002	8-32 X 3/8" Panhead Screw	10
60020059	Mechanical Float Sensor	1	70020065	Flat Back Mounting Bracket for M3 Control Panel	1
60090019	MNU Level Sensor Assembly w/ Standpipe & Fan	1			

FRONTLINE
international
187 ASCOT PARKWAY
CUYAHOGA FALLS, OH 44223

TITLE 3073SQ Parts View
PART NUMBER 3073SQ
2/1/24 SHEET 1 OF 3

3073SQ Parts View

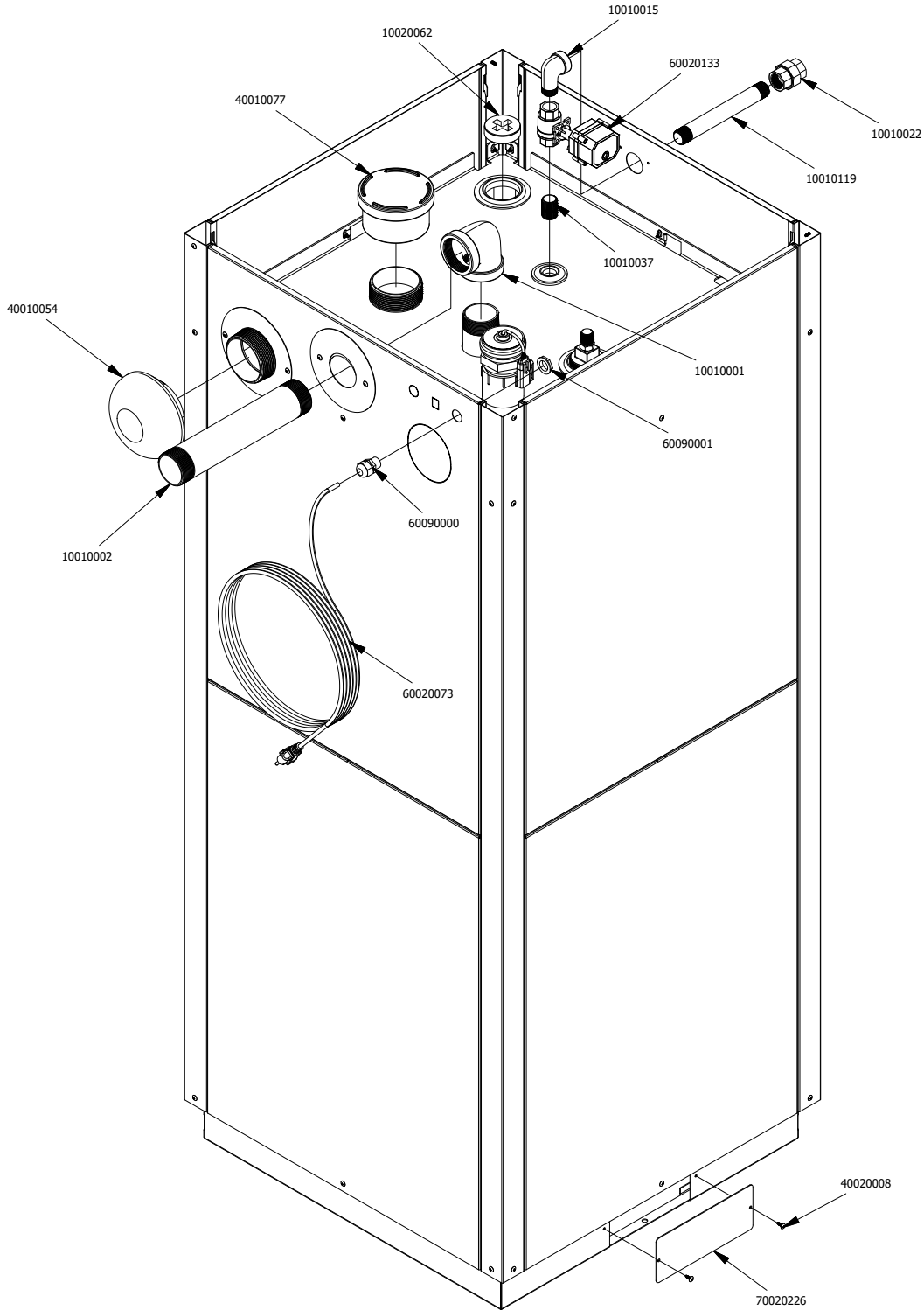

Part Number	Description	Qty	Part Number	Description	Qty
60090000	1/2" NPT Domed Cord Strain Relief	1	40010054	3" Tank Vent	1
60020073	10' NEMA 5-15P Power Cord	1	60090001	1/2" NPT Nut	1
40020008	10-24 x 1/2" Truss Head Screw	36	10010002	2" X 12" Black Iron Nipple	1
10010001	2" 90 Deg. Galv. Elbow	1	10010037	3/4" Galv. Close Nipple	1
40010077	3" Spring-Loaded Emergency Vent	1	10010015	3/4" Galv. 90 deg. Street Elbow	1
60020133	3/4" Two Way SS Valve w/ Spring Close	1	10010119	3/4" x 8" Galv. Nipple	1
10010022	3/4" Galvanized Union	1	10020062	2" PVC Flush Plug	1

FRONTLINE
international
187 ASCOT PARKWAY
CUYAHOGA FALLS, OH 44223

TITLE 3073SQ Parts View
PART NUMBER 3073SQ

2/1/24 SHEET 2 OF 3

M3 Gen 3 Control Panel Wiring Diagram

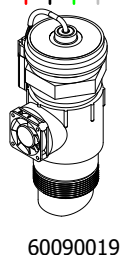
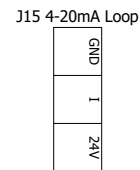
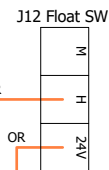
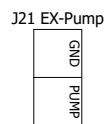
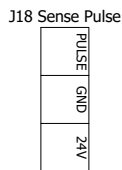
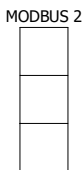
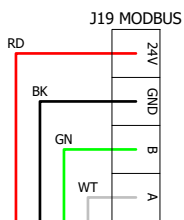
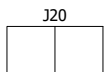
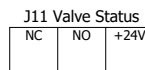
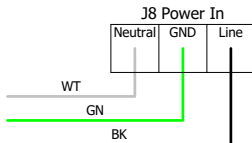
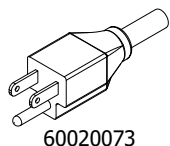
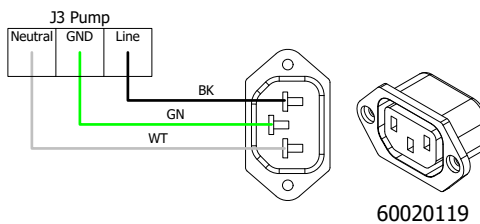
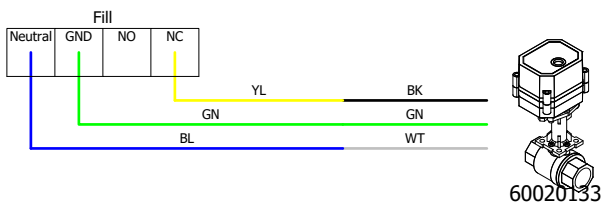
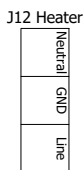
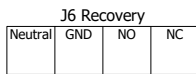
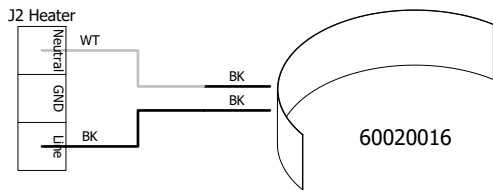

NOTE:
Shield Braid should be connected to GND

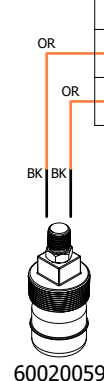

TOLERANCES ARE:
.XX: ± .010
.XXX: ± .005
ANGULAR: ± .5°

FRONTLINE
international

187 ASCOT PARKWAY
CUYAHOGA FALLS, OH 44223

THIS DRAWING IS
CONFIDENTIAL
PROPERTY OF
FRONTLINE
INTERNATIONAL

TITLE
3073SQ Wiring Diagram

DRAWN CCB SHEET 3 OF 3