

# 3073SQ-O-HV Parts View

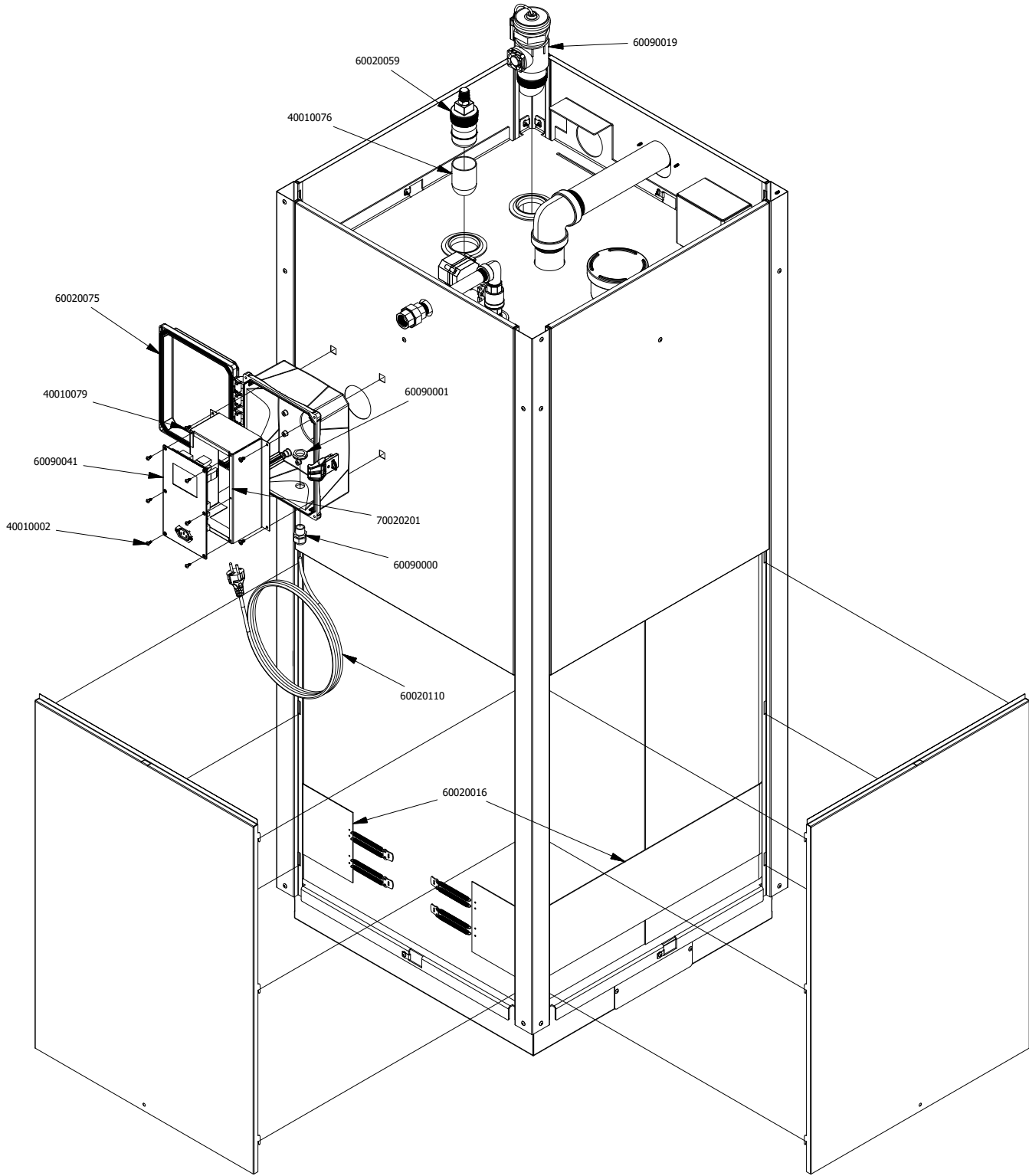

Part Number	Description	Qty	Part Number	Description	Qty
40010002	8-32 X 3/8" Panhead Screw	6	60090000	1/2" NPT Domed Cord Strain Relief	1
40010076	Silicone Cap for Mechanical Float Sensor	1	60090001	1/2" NPT Nut	1
40010079	10-32 x 3/8 Panhead Screw	4	60090019	MNU Level Sensor Assembly w/ Standpipe & Fan	1
60020016	120V 250W Heater Belt	2	60090041	M3 Gen 3 Control Panel assembled & mounted for NA	1
60020059	Mechanical Float Sensor	1	70020201	NEMA Enclosure Mounting Bracket for M3 Control Panel	1
60020075	Weatherproof NEMA Enclosure	1	60020110	Power Supply Cord, Schucko CEE 7/7 for EU Outlet	1

**FRONTLINE**  
international  
187 ASCOT PARKWAY  
CUYAHOGA FALLS, OH 44223

TITLE: 3073SQ-O-HV Parts View  
PART NUMBER: 3073SQ-O-HV

2/1/24 SHEET 1 OF 3

# 3073SQ-O-HV Parts View

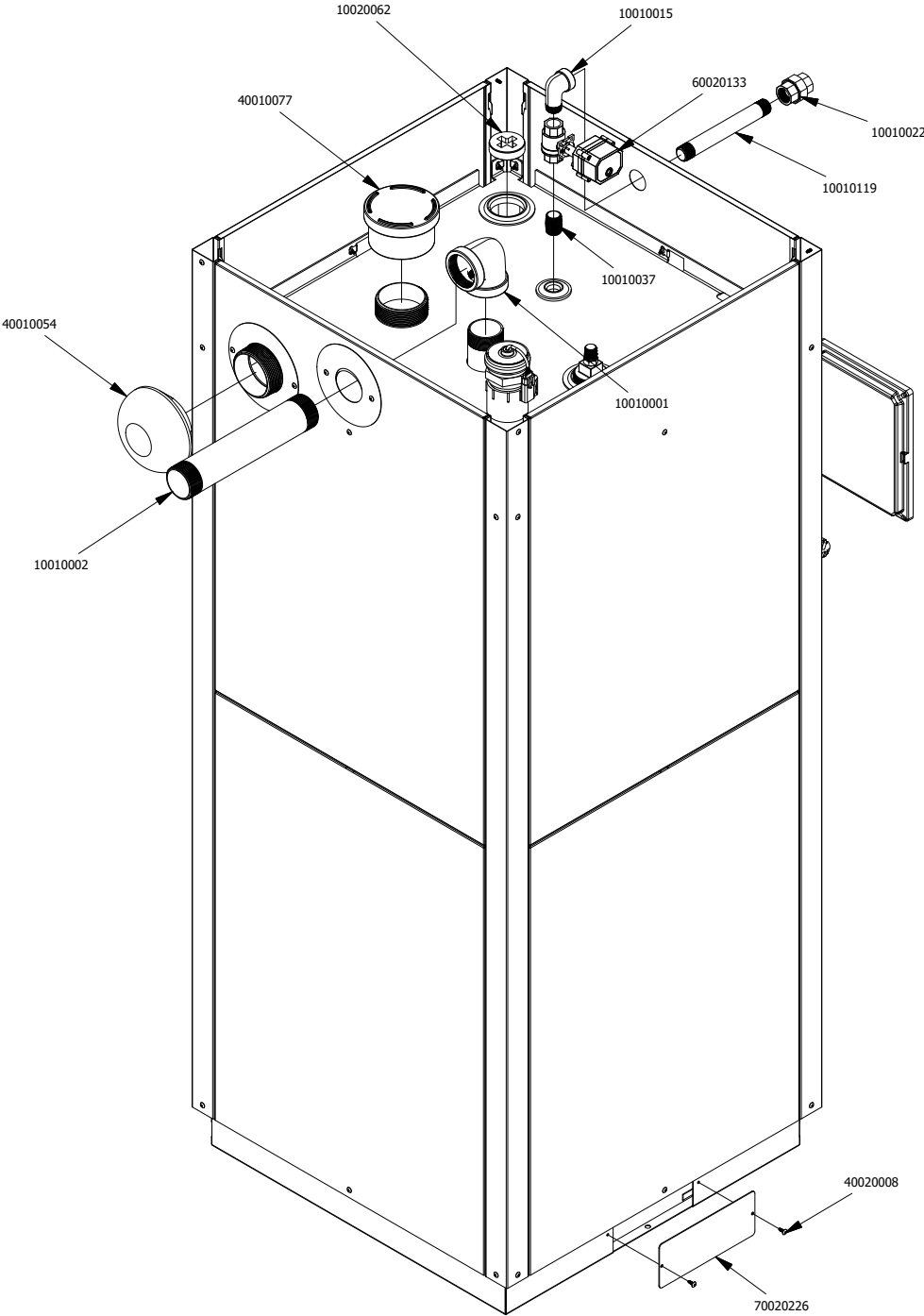

Part Number	Description	Qty	Part Number	Description	Qty
10010001	2" 90 Deg. Galv. Elbow	1	10020062	2" PVC Flush Plug	1
10010002	2" X 12" Black Iron Nipple	1	40010054	3" Tank Vent	1
10010015	3/4" Galv. 90 deg. Street Elbow	1	40010077	3" Spring-Loaded Emergency Vent	1
10010022	3/4" Galvanized Union	1	40020008	10-24 x 1/2" Truss Head Screw	36
10010037	3/4" Galv. Close Nipple	1	60020133	3/4" Two Way SS Valve w/ Spring Close	1
10010119	3/4" x 8" Galv. Nipple	1	70020226	Modular Tank Pallet Base Hole Cover	2

**FRONTLINE**  
international  
187 ASCOT PARKWAY  
CUYAHOGA FALLS, OH 44223

TITLE: 3073SQ-O-HV Parts View  
PART NUMBER: 3073SQ-O-HV

2/1/24 SHEET 2 OF 3

# M3 Gen 3 Control Panel w/ Remote Switch Kit

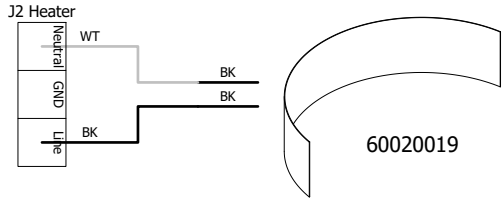

60020019

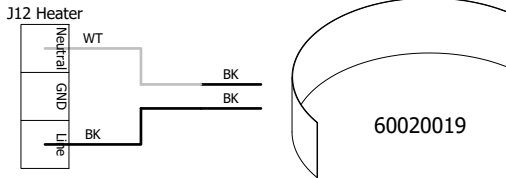
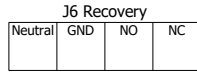

60020019

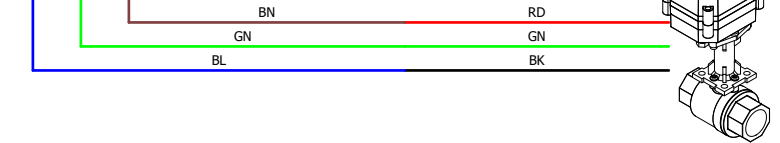
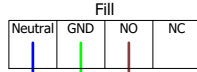

60020133

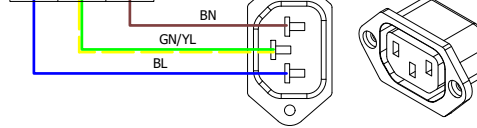
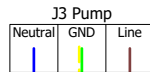

60020119

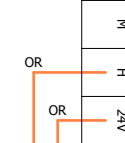
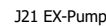
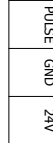
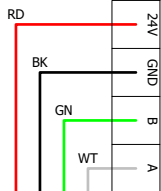
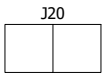
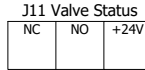
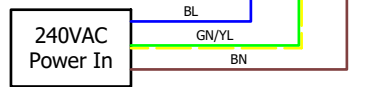
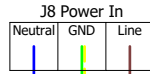
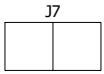

60020059 Normally Open

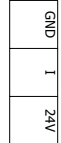
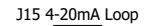

60090019

**NOTE:**  
Shield Braid should be connected to GND

TOLERANCES ARE:  
.XX: ± .010  
.XXX: ± .005  
ANGULAR: ± .5°

**FRONTLINE**  
international

187 ASCOT PARKWAY  
CUYAHOGA FALLS, OH 44223

THIS DRAWING IS  
CONFIDENTIAL  
PROPERTY OF  
FRONTLINE  
INTERNATIONAL

TITLE 3073SQ-O-HV Parts View  
Wiring Diagram

DRAWN CCB SHEET 3 OF 3